

# home spaces



# home spaces



# indice

## index

### il sistema the system

**06** progettualità  
about design

### ambienti rooms

**14** ingresso  
entrance

**40** soggiorno  
living room

**128** camera  
bedroom

**190** lavanderia  
laundry

**226** spazi utili  
utility spaces

### sezione tecnica technical section

**264** finiture e colori  
finishes and colours

**266** tessuti  
fabrics

**270** maniglie  
handles

**280** contenitori  
storage units

**284** librerie  
bookcases

**288** sistema Uniko  
Uniko system

**290** boiserie  
wall panelling

**294** armadi  
wardrobes

**302** cabine  
walk-in closets

**306** letti  
beds

**324** gruppi letto  
bedroom units

**328** scrivanie  
desks

**336** tavoli e sedie  
tables and chairs

**il sistema**  
the system

# Cinquanta3, il sistema

## Cinquanta3, the system



**Un'ampia gamma di elementi d'arredo modulari, progettati per organizzare in modo funzionale il quotidiano e moltiplicare, con stile, lo spazio casa.**

An extensive range of modular items of furniture, designed to organize daily life in a functional way and multiply home spaces stylishly.

# Cinquanta3, il sistema

## Cinquanta3, the system

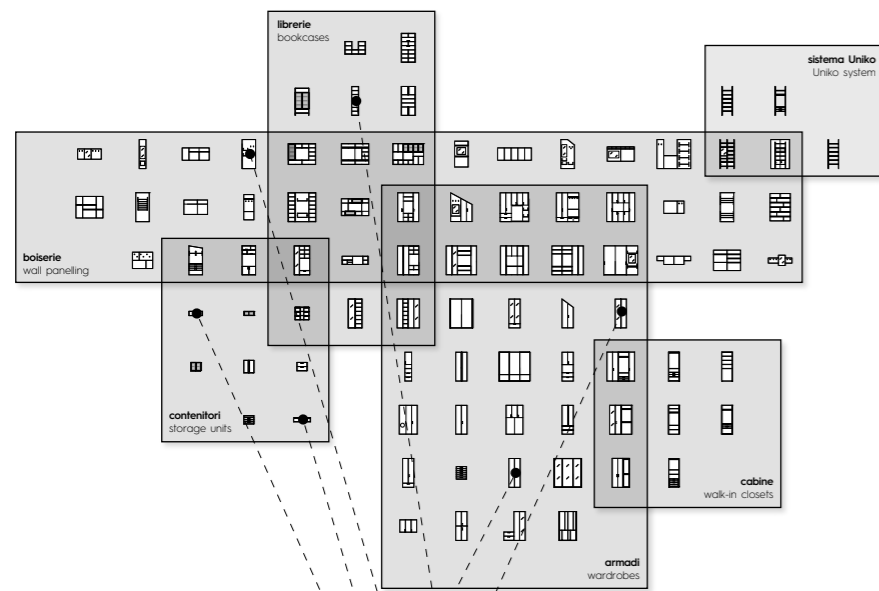

### Progettare in libertà

The freedom to design your way

**La versatilità degli elementi permette massima libertà compositiva: il progetto d'arredo si fa interprete del vivere moderno, alla ricerca di soluzioni personalizzabili e funzionali, dal sapore quotidiano.**

The versatility of the various elements gives the ultimate freedom to put your scheme together just the way you want: the interior's design embodies our modern lifestyle, in the pursuit of functional, customizable solutions, with an everyday feel.

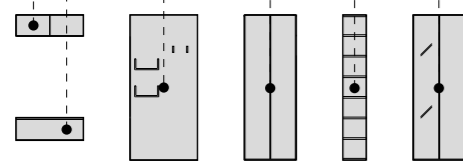

**singoli elementi del sistema**  
individual parts of the system

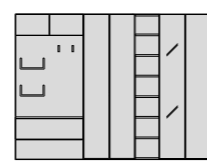
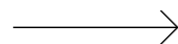

**composizione finita**  
finished configuration

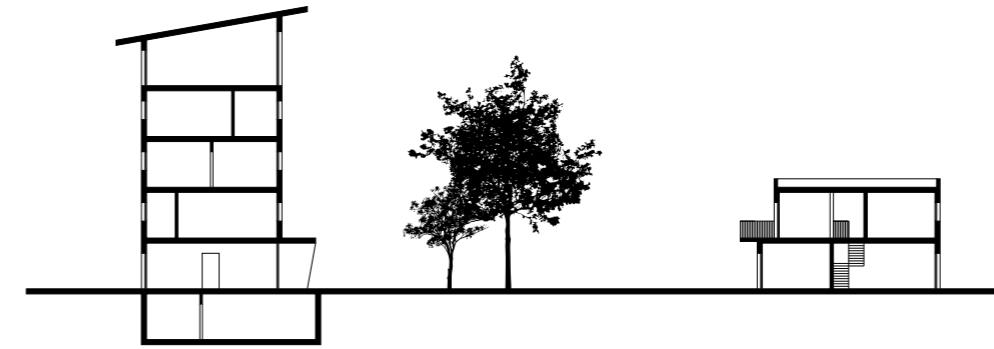

### Ridefinire lo spazio casa

Redefining home spaces

**Ambienti organizzati che dialogano tra loro, grazie all'ampia gamma di elementi pensati per coesistere all'interno dello stesso progetto. La casa indossa gli abiti di chi la vive.**

Organized interiors that share a connection with each other, thanks to the extensive range of elements designed to sit happily alongside each other within the same scheme. The home mirrors the style of its occupants.

**Ingresso**  
Entrance

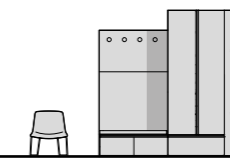

**Soggiorno**  
Living room

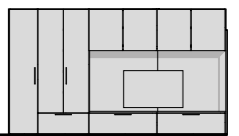

**Camera**  
Bedroom



**Lavanderia**  
Laundry

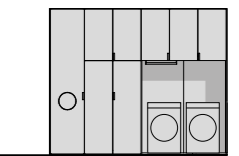

**Dispensa**  
Pantry

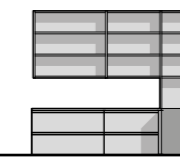

**Garage**  
Garage

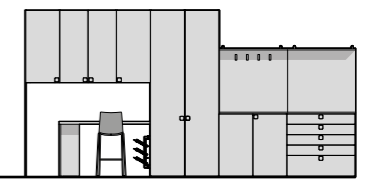

**Ripostiglio**  
Walk-in cupboard



**Disimpegno**  
Vestibule

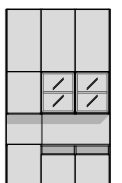

# Spazi razionali da vivere con passione

Rational spaces for you to  
enjoy with a passion

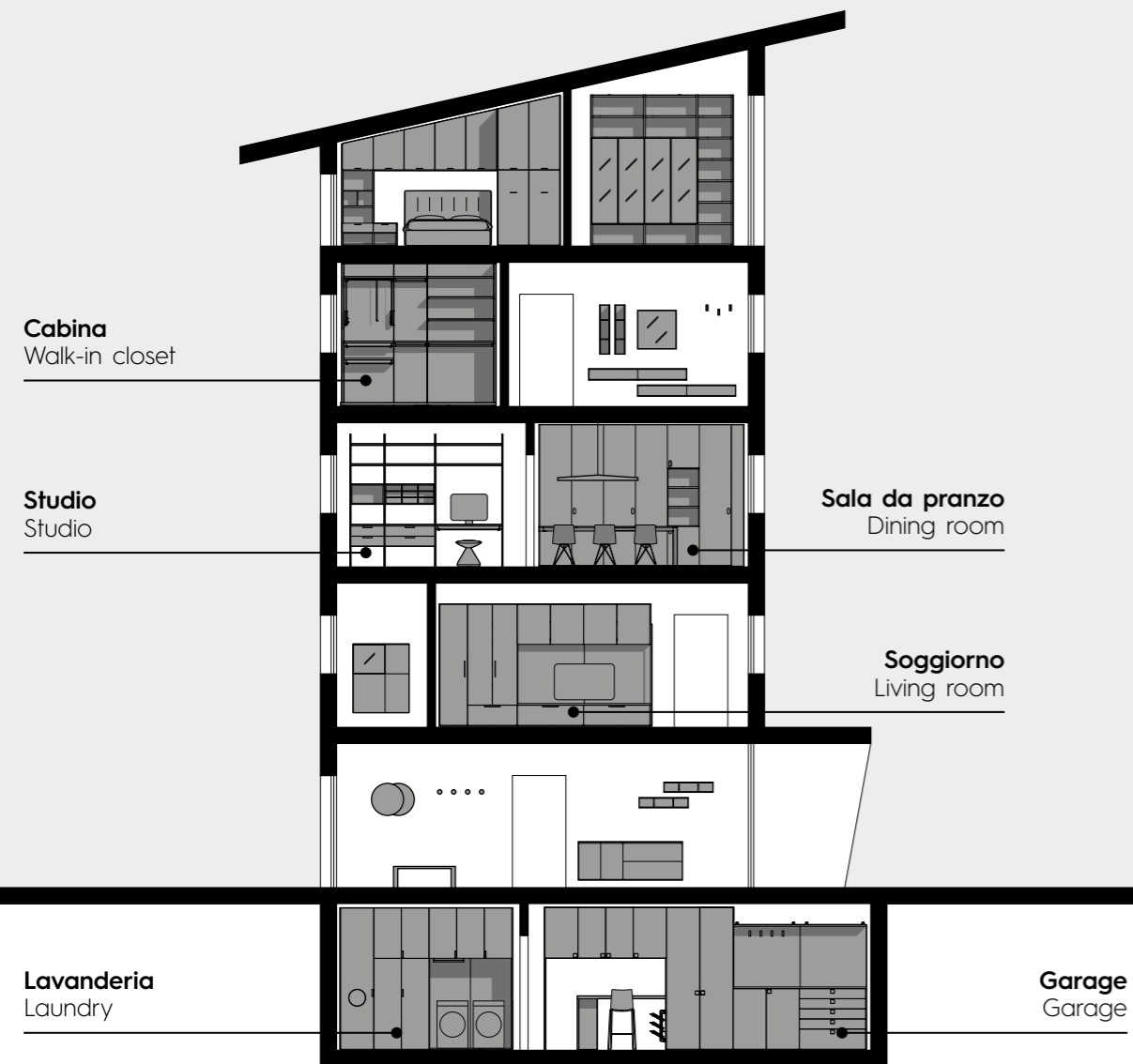

Progettare uno spazio ottimale a misura di quotidiano, nel quale identificarsi e sentirsi a casa. Vestire gli ambienti di elementi contenitivi e decorativi, capaci di definire in modo intelligente e armonico l'intero progetto casa, interpretando le esigenze e lo spirito del vivere contemporaneo.

Designing an optimal space tailor made to accommodate daily life, a space to identify with and feel at home in. Decking out interiors with storage units and decorative elements, capable of bringing to life the whole interior design vision in a smart and harmonious way, interpreting the demands and spirit of our contemporary lifestyles.



**ambient**  
rooms

ambient  
rooms

# Non tutti gli ingressi sono uguali

Not all entrances are the same

## ingresso con ribassamento / entrance with bulkhead

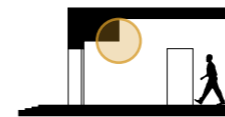

01a - pag. 16



01b - pag. 20



01c - pag. 22

## ingresso con scale / entrance with stairs

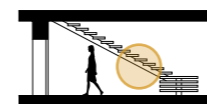

02a - pag. 24



02b - pag. 28



02c - pag. 30

**Il sistema cinquanta3 permette di personalizzare la zona ingresso, ottimizzando gli spazi in base al progetto. La modularità delle composizioni risponde in modo efficace alle caratteristiche di ogni ambiente anche in presenza di vincoli architettonici come ribassamenti, scale o finestre.**

The cinquanta3 system gives you the tools you need to put your personal stamp on the entry area, optimizing spaces based on its design. The configurations' modular design caters effectively to the individual quirks of each room, even when dealing with architectural constraints, such as bulkheads, stairs or windows.

## ingresso con finestra / entrance with window

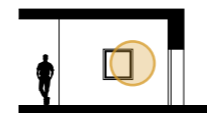

03a - pag. 32



03b - pag. 36



03c - pag. 38

# 01a - 01b - 01c

## Ingresso Entrance

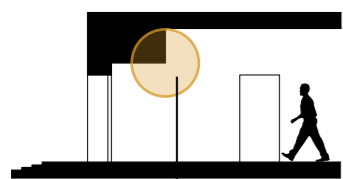

ribassamento  
bulkhead

**Le diverse composizioni propongono soluzioni funzionali alla presenza di un ingresso con ribassamento. Sfruttare al meglio lo spazio, ridefinendo l'ambiente in base ai dettagli del progetto, grazie ad elementi dall'ampia modularità, capaci di vestire con stile ambienti abitativi differenti.**

The different configurations offer functional solutions to deal with a bulkhead protruding into an entrance. Making the best use of space, redefining the interior based on its design details with the aid of elements featuring a modular design providing plenty of options, resolving different home spaces with a stylish fit out.



Ingresso  
Entrance





**composizione ingresso**  
entrance configuration

L / W 265,5 cm  
H / H 220,8 - 257,9 cm  
P / D 61 cm

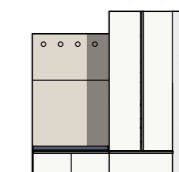

**elementi / elements**

**boiserie Arnad** / Arnad wall panelling  
**pomoli appendiabifi** / clothes hanger knobs  
**basi armadio** / wardrobe base units  
**seduta imbottita** / padded seat  
**armadio battente** / hinged door wardrobe  
**terminale libreria** / bookcase end unit

**finiture / finishes**

**bianco** / bianco  
**frassino chiaro** / frassino chiaro  
**specchio chiaro** / light mirror  
**thick T522** / thick T522





01a - **01b** - 01c  
**Ingresso**  
 Entrance



**composizione ingresso**  
 entrance configuration

L / W 264 cm  
 H / H 221,3 - 257,9 cm  
 P / D 35,8 cm

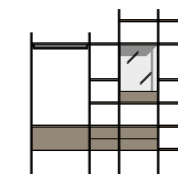

**elementi / elements**

**sistema Uniko / Uniko system**

**boiserie Arnad / Arnad wall panelling**

**specchio per boiserie / mirror for wall panelling**

**finiture / finishes**

**lavagna / lavagna**

**rovere cotto / rovere cotto**

**specchio chiaro / light mirror**

**sedie Sneek / Sneek chairs**

**J10, basamento R2 nero - pag. 343 / J10, black R2 base - page 343**

**tavolo Corby / Corby table**

**rovere cotto, lavagna - pag. 337 / rovere cotto, lavagna - page 337**

# 01a - 01b - 01c

## Ingresso

### Entrance



#### composizione ingresso

entrance configuration

L / W 270 cm  
H / H 220,5 - 267 cm  
P / D 35,8 cm

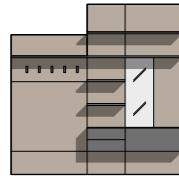

#### elementi / elements

**boiserie Arnad** / Arnad wall panelling  
**mensole sp. 3 cm** / 3 cm-thick shelves  
**basi sospese** / wall-mounted base units  
**ganci appendiabiti** / coat hooks  
**specchio per boiserie** / mirror for wall panelling

#### finiture / finishes

**noce naturale** / noce naturale  
**cemento** / cemento  
**specchio chiaro** / light mirror  
**brunito** / bronze





# 02a - 02b - 02c

## Ingresso Entrance

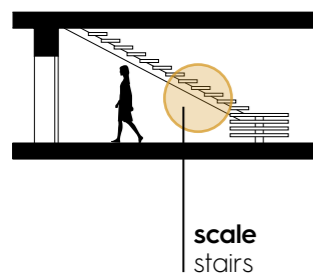

**Progettare spazi intelligenti, studiati in modo organizzato: il sottoscala diventa parte integrante del progetto e si veste di elementi d'arredo funzionali e decorativi. Tre differenti composizioni, tre diversi modi di vivere il quotidiano.**

Designing clever spaces with organization: the space under the stairs becomes an integral part of the design and accommodates functional and decorative items of furniture for a resolved look. Three different configurations, three different approaches to the needs of everyday life.





**composizione ingresso**  
entrance configuration

L / W 352,5 cm  
H / H 98,5 - 257,9 cm  
P / D 60,6 cm

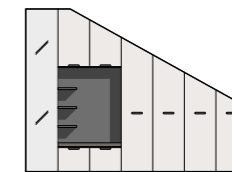

**elementi** / elements

**armadio battente** / hinged door wardrobe  
**ripiani sagomati** / shaped shelves  
**seduta imbottita** / padded seat

**finiture** / finishes

**calce** / calce  
**cemento** / cemento  
**specchio chiaro** / light mirror  
**cross T513** / cross T513



02a - **02b** - 02c

# Ingresso

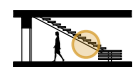

## Entrance

### composizione ingresso entrance configuration

L / W 390 cm  
H / H 83 - 257,2 cm  
P / D 49,1 cm

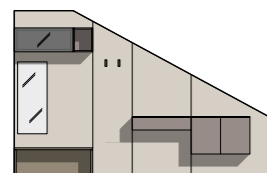

### elementi / elements

**boiserie Cover** / Cover wall panelling  
**pensile** / wall unit  
**casellario** / shelving unit  
**specchio per boiserie** / mirror for wall panelling  
**portavaligie** / luggage shelf  
**ganci appendiabiti** / coat hooks  
**basi sospese** / wall-mounted base units

### finiture / finishes

**canapa** / canapa  
**rovere cotto** / rovere cotto  
**basalto** / basalto  
**specchio chiaro** / light mirror  
**vetro fumé** / smoked glass  
**brunito** / bronze



**pouf Tokyo** / Tokyo ottoman  
TL34 - pag. 347 / TL34 - page 347



Ingresso  
Entrance

02a - 02b - **02c**  
**Ingresso**  
 Entrance



**composizione ingresso**  
 entrance configuration

L / W 360 cm  
 H / H 100 - 257,2 cm  
 P / D 64,3 cm

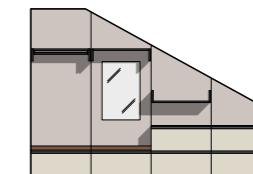

**elementi / elements**

**boiserie Cover** / Cover wall panelling  
**componenti Cover** / Cover components  
**basi a terra** / floorstanding base units  
**seduta imbottita** / padded seat  
**specchio per boiserie** / mirror for wall panelling

**finiture / finishes**

**cashmere** / cashmere  
**frassino chiaro** / frassino chiaro  
**lavagna** / lavagna  
**soft T566** / soft T566  
**specchio chiaro** / light mirror



# 03a - 03b - 03c

## Ingresso Entrance

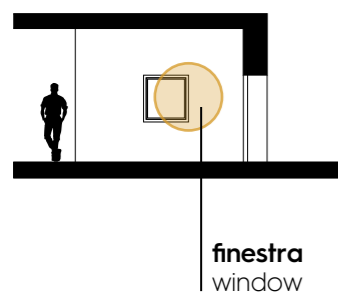

**Grazie alla flessibilità compositiva degli elementi d'arredo, una parete con finestra diventa uno spazio strutturato. L'ingresso si trasforma, acquistando personalità e diventando un ambiente utile e funzionale, ma soprattutto piacevole da vivere.**

With the various items of furniture offering modular flexibility, a wall with a window becomes a well-structured space. The entrance is transformed, packed with personality and turned into a useful and functional interior and, above all, a space you'll want to spend time in.



Ingresso  
Entrance





**composizione ingresso**  
entrance configuration

L / W 265,1 cm  
H / H 257,9 cm  
P / D 35,4 cm

L / W 208,1 cm  
H / H 257,9 cm  
P / D 35,4 cm

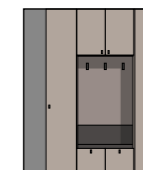
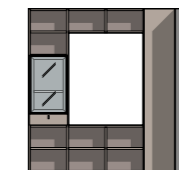

**elementi / elements**

- libreria a terra e sospesa** / floorstanding and wall-mounted bookcase
- boiserie Arnad** / Arnad wall panelling
- seduta imbottita** / padded seat
- ganci appendiabiti** / coat hooks

**finiture / finishes**

- basalto** / basalto
- sabbia** / sabbia
- vetro acidato** / etched glass
- thick T524** / thick T524
- brunito** / bronze

**sedia Sneek lounge** / Sneek lounge chair  
thick T524, nero - pag. 347  
thick T524, black - page 347



03a - **03b** - 03c

 **Ingresso**  
Entrance



**composizione ingresso**  
entrance configuration

L / W 273,6 cm  
H / H 221,6 cm  
P / D 49,1 cm

L / W 183,3 cm  
H / H 221,6 cm  
P / D 49,1 cm

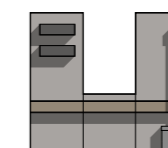

**elementi / elements**

**boiserie Cover** / Cover wall panelling  
**mensole in metallo** / metal shelves  
**basi sospese** / wall-mounted base units  
**basi a terra** / floorstanding base units  
**seduta imbottita** / padded seat  
**ganci appendiabiti** / coat hooks  
**specchio per boiserie** / mirror for wall panelling

**finiture / finishes**

**intonaco** / intonaco  
**rovere colto** / rovere colto  
**brunito** / bronze  
**specchio chiaro** / light mirror  
**spot T544** / spot T544  
**lavagna** / lavagna

**sedia Cannes** / Cannes chair  
TL30 - pag. 345 / TL30 - page 345



# 03a - 03b - 03c

## Ingresso

### Entrance



#### composizione ingresso

entrance configuration

L / W 275,4 cm    L / W 168,2 cm  
 H / H 203 cm    H / H 203 cm  
 P / D 45,8 cm    P / D 45,8 cm

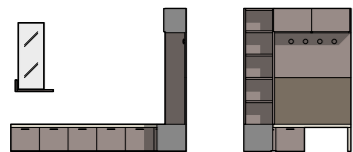

#### elementi / elements

specchio / mirror  
 mensola ad L / L-shaped shelf  
 basi a terra / floorstanding base units  
 piani in appoggio / sit-on-top tops  
 libreria sovrapposta e sospesa  
 sit-on-top and wall-mounted bookcase  
 boiserie Arnad / Arnad wall panelling  
 pomoli appendiabiti / clothes hanger knobs

#### finiture / finishes

basalto / basalto  
 frassino chiaro / frassino chiaro  
 specchio chiaro / light mirror  
 spot T548 / spot T548



Ingresso  
Entrance



# Un soggiorno razionale e personalizzato

A rational, tailor-made living room

**Il progetto d'arredo si integra e armonizza con l'ambiente, esaltandone le peculiarità. L'ampia gamma di elementi permette di personalizzare e adattare la composizione alle caratteristiche dei diversi spazi abitativi. Per sentirsi comodamente a casa.**

The furniture scheme blends seamlessly and harmoniously with the interior, highlighting its distinctive features. The extensive range of elements means the configuration can be tailored to the features of the various home interiors. So you can feel right at home.

## soggiorno con parete divisoria / living room with dividing wall

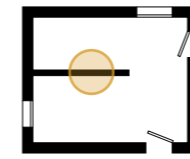

04a - pag. 42



04b - pag. 48



04c - pag. 52



04d - pag. 58



04e - pag. 64

## soggiorno ad angolo / corner living room

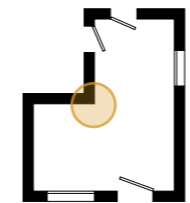

05a - pag. 68



05b - pag. 76



05c - pag. 82



05d - pag. 88

## soggiorno con pilastro / living room with pillar

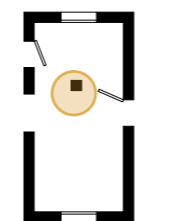

06a - pag. 94



06b - pag. 102



06c - pag. 106



06d - pag. 112

## monocale / studio apartment

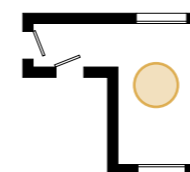

07a - pag. 118



07b - pag. 124



# 04a - 04b - 04c - 04d - 04e

## Soggiorno

Living room

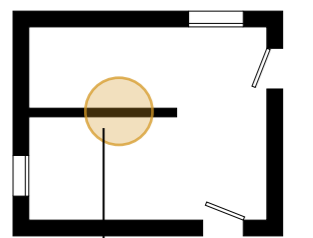

parete divisoria  
dividing wall

**Progettare un angolo relax pensato per sfruttare al meglio la presenza di una parete divisoria. Una composizione che si adatta perfettamente all'ambiente e che risponde, con stile, alle esigenze funzionali del quotidiano.**

Designing a chill-out space so that it makes the best use of a dividing wall. A configuration that adapts perfectly to the room and caters to the functional needs of everyday life with stylish flair.





**parete attrezzata**  
wall system

L / W 385 cm  
H / H 221,3 cm  
P / D 61 cm

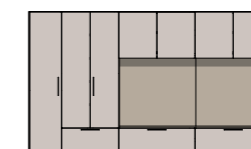

**elementi** / elements

**armadio ponte con fianco metallico**  
bridging wardrobe with metal side panel  
**basi armadio** / wardrobe base units  
**boiserie Arnad** / Arnad wall panelling

**finiture** / finishes

**cashmere** / cashmere  
**noce naturale** / noce naturale





**madia sospesa**  
wall-mounted sideboard

L / W 228 cm  
H / H 74,7 cm  
P / D 35,4 cm



**elementi** / elements

**libreria sospesa** / wall-mounted bookcase

**finiture** / finishes

**noce naturale** / noce naturale  
**cashmere** / cashmere

**piano sospeso con alzata sp. 5 cm** / 5 cm-thick wall-mounted top with upstand  
**noce naturale** - pag. 332 / noce naturale - page 332

**sgabelli Sneek** / Sneek stools  
**J10, nero** - pag. 346 / J10, black - page 346





04a - **04b** - 04c - 04d - 04e

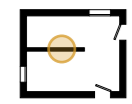

# Soggiorno

Living room



**sedie Sneek imbottite** / upholstered Sneek chairs  
**spot T544, basamento RI** - pag. 343  
spot T544, RI base - page 343

**tavolo Corby a penisola** / Corby peninsula table  
**noce naturale, lavagna** - pag. 337  
noce naturale, lavagna - page 337





**tavolino Orig** / Orig side table  
**lavagna - pag. 327** / lavagna - page 327

**parete attrezzata**  
 wall system

**L / W 540,6 cm**  
**H / H 239,9 cm**  
**P / D 48,8 cm**

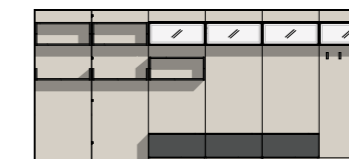

**elementi** / elements

**boiserie Cover** / Cover wall panelling  
**componenti Cover** / Cover components  
**pensili** / wall units  
**basi in appoggio** / sit-on-top base units  
**pedana h 5,7 cm** / plinth H 5,7 cm  
**ganci appendiabiti** / coat hooks

**finiture** / finishes

**canapa** / canapa  
**lavagna** / lavagna  
**vetro trasparente** / transparent glass  
**brunito** / bronze



04a - 04b - **04c** - 04d - 04e

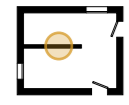

## Soggiorno

Living room

**parete attrezzata**  
wall system

L / W 270 cm  
H / H 193 cm  
P / D 45,8 cm

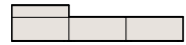

**elementi** / elements

**basi a terra** / floorstanding base units  
**pensili** / wall units  
**casellari** / shelving units

**finiture** / finishes

**nuvola** / nuvola  
**frassino chiaro** / frassino chiaro





**composizione home office**  
home office configuration

L / W 277,2 cm  
H / H 239,6 cm  
P / D 45,8 cm

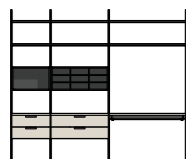

**elementi / elements**  
**sistema Uniko / Uniko system**

**finiture / finishes**

**lavagna / lavagna**  
**frassino chiaro / frassino chiaro**



**tavolino Orig / Orig side table**  
**frassino chiaro, lavagna - pag. 327**  
frassino chiaro, lavagna - page 327

**divano Madrid / Madrid sofa**  
**spot T543, fettuccia a contrasto CC14 - pag. 348**  
spot T543, CC14 contrasting piping - page 348

**pouf Tokyo / Tokyo ottoman**  
**TL31 - pag. 347 / TL31 - page 347**

**mensole in metallo** / metal shelves  
**lavagna** / lavagna

**sala da pranzo**  
dining room

L / W 360 cm  
H / H 79,9 cm  
P / D 45,8 cm



**elementi** / elements

**boiserie Arnad** / Arnad wall panelling  
**piani in appoggio** / sit-on-top tops  
**basi a terra** / floorstanding base units

**finiture** / finishes

**lavagna** / lavagna  
**frassino chiaro** / frassino chiaro  
**soff T564** / soff T564

**sedie Sneek** / Sneek chairs  
**J10, basamento R2 nero** - pag. 342 / J10, black R2 base - page 342

**tavolo Leone Large** / Leone Large table  
**lavagna** - pag. 336 / lavagna - page 336





04a - 04b - 04c - **04d** - 04e

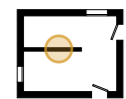

## Soggiorno

Living room

**parete attrezzata**  
wall system

L / W 573 cm  
H / H 257,9 cm  
P / D 47,4 cm

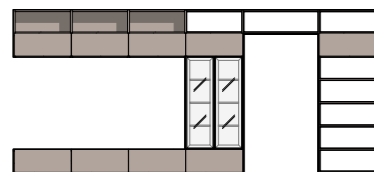

**elementi / elements**  
**libreria a terra e sospesa**  
floorstanding and wall-mounted bookcase

**finiture / finishes**  
**sabbia** / sabbia  
**vetro trasparente** / transparent glass  
**lavagna** / lavagna





**composizione ingresso**  
entrance configuration

L / W 120 cm  
H / H 221,3 cm  
P / D 45,8 cm



**elementi / elements**  
**portavaligie con schiena**  
luggage shelf with back panel  
**seduta imbottita / padded seat**  
**ganci appendiabiti / coat hooks**

**finiture / finishes**

**rovere cotto / rovere cotto**  
**cross T504 / cross T504**  
**brunito / bronze**





**sedie Nerja** / Nerja chairs  
**fiesta di moro** - pag. 343 / dark brown - page 343  
**tavolo Leone Large** / Leone Large table  
**rovere cotto, lavagna** - pag. 336 / rovere cotto, lavagna - page 336



04a - 04b - 04c - 04d - **04e**

## Soggiorno

Living room

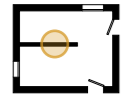

**parete attrezzata**  
wall system

L / W 330 cm  
H / H 203 cm  
P / D 45,8 cm

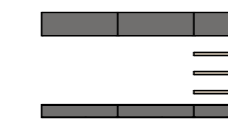

**elementi** / elements

**pensili** / wall units

**mensole sp. 5 cm** / 5 cm-thick shelves

**basi sospese** / wall-mounted base units

**finiture** / finishes

**cemento** / cemento

**noce naturale** / noce naturale

**sedie Giant** / Giant chairs

**J21 - pag. 342** / J21 - page 342

**piano scrivania sp. 5 cm con fianco**

5 cm-thick desk top with side panel

**noce naturale - pag. 328** / noce naturale - page 328





**madia**  
sideboard

L / W 123 cm  
H / H 111,5 cm  
P / D 45,4 cm



**elementi** / elements

**libreria con gambe metalliche**  
bookcase with metal legs

**finiture** / finishes

**cemento** / cemento  
**vetro acidato** / etched glass  
**lavagna** / lavagna



# 05a - 05b - 05c - 05d

## Soggiorno Living room

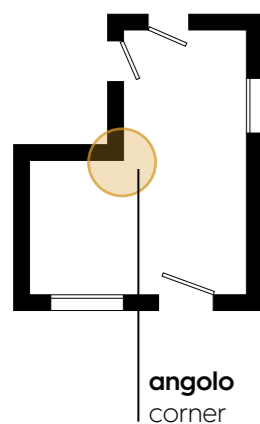

**La parete ad angolo trasforma la stanza in due ambienti distinti, dove trovano posto la zona relax e la sala da pranzo. La modularità degli elementi caratterizza le diverse composizioni e permette di personalizzare ogni progetto per renderlo unico.**

The corner wall turns the room into two separate areas, housing the chill-out area and dining room respectively. The modular design of the various elements gives the different configurations their distinctive look and allows you to tailor each project to your individual needs, making each unique.







**ganci appendiabiti** / coat hooks  
**brunito** - pag. 279 / bronze - page 279  
**mensole in metallo** / metal shelves  
**nuvola** / nuvola

**composizione ingresso**  
 entrance configuration

**L / W 270 cm**  
**H / H 43,3 cm**  
**P / D 45,8 cm**



**elementi** / elements  
**basi a terra** / floorstanding base units  
**piano in appoggio** / sit-on-top top

**finiture** / finishes  
**nuvola** / nuvola  
**frassino chiaro** / frassino chiaro







**sedie Cork** / Cork chairs  
 J00 - pag. 342 / J00 - page 342  
**scrivania sp. 1,2 cm** / 1,2 cm-thick desk  
 bianco, frassino chiaro - pag. 334 / bianco, frassino chiaro - page 334

**composizione libreria**  
 bookcase configuration

L / W 423 cm  
 H / H 294,5 cm  
 P / D 35,4 cm

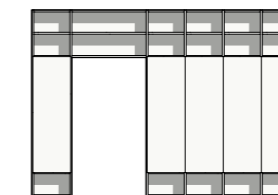

**elementi** / elements  
**libreria a terra** / floorstanding bookcase

**finiture** / finishes  
 bianco / bianco



**parete attrezzata**  
wall system

L / W 450 cm  
H / H 215 cm  
P / D 45,8 cm

L / W 213 cm  
H / H 215 cm  
P / D 58,2 cm

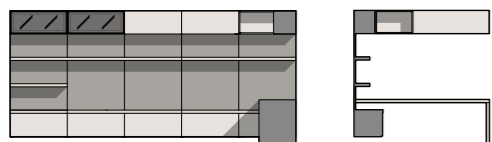

**elementi** / elements

**basi sospese** / wall-mounted base units

**pensili** / wall units

**boiserie Arnad** / Arnad wall panelling

**mensole sp. 5 cm** / 5 cm-thick shelves

**casellari** / shelving units

**piano scrivania sp. 5 cm con fianco** / 5 cm-thick desk top with side panel

**finiture** / finishes

**nuvola** / nuvola

**intonaco** / intonaco

**frassino chiaro** / frassino chiaro

**vetro fumé** / smoked glass



**sedia Cannes** / Cannes chair  
TL32 - pag. 345 / TL32 - page 345



05a - **05b** - 05c - 05d

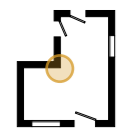

# Soggiorno

Living room



**tavolo Corby a penisola** / Corby peninsula table  
noce naturale, bianco - pag. 337  
noce naturale, bianco - page 337

**sedie Sneek imbottite** / upholstered Sneek chairs  
thick T526, basamento R1 - pag. 343  
thick T526, R1 base - page 343





**sedia Sneek lounge** / Sneek lounge chair  
 cross T502, nero - pag. 347 / cross T502, black - page 347

**parete attrezzata**  
 wall system

L / W 445 cm  
 H / H 294,5 cm  
 P / D 60,6 cm

L / W 332 cm  
 H / H 294,5 cm  
 P / D 35,8 cm

L / W 360 cm  
 H / H 190 cm  
 P / D 61 cm

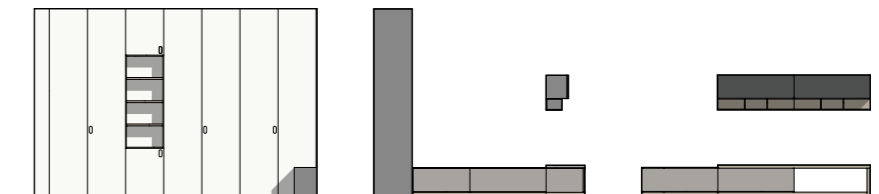

**elementi** / elements

**armadio battente** / hinged door wardrobe  
**basi in appoggio** / sit-on-top base units  
**pedana h 5,7 cm** / plinth H 5,7 cm  
**piano in appoggio** / sit-on-top top  
**pensili** / wall units  
**casellari Zip12** / Zip12 shelving units

**finiture** / finishes

**bianco** / bianco  
**intonaco** / intonaco  
**noce naturale** / noce naturale  
**lavagna** / lavagna





**composizione ingresso**  
entrance configuration

L / W 270 cm  
H / H 167,5 cm  
P / D 35,8 cm

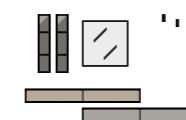

**elementi / elements**

**basi sospese** / wall-mounted base units  
**casellari Zip12** / Zip12 shelving units  
**specchio** / mirror  
**ganci appendiabiti** / coat hooks

**finiture / finishes**

**intonaco** / intonaco  
**noce naturale** / noce naturale  
**brunito** / bronze





05a - 05b - **05c** - 05d

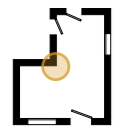

## Soggiorno

Living room

**parete attrezzata**  
wall system

L / W 332,4 cm  
H / H 294,5 cm  
P / D 61 cm

L / W 522,6 cm  
H / H 294,5 cm  
P / D 61 cm

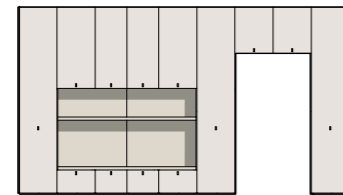

**elementi** / elements

**armadio battente** / hinged door wardrobe  
**libreria a terra** / floorstanding bookcase  
**armadio ponte** / bridging wardrobe  
**mensola sp. 5 cm** / 5 cm-thick shelf  
**piano in appoggio** / sit-on-top top  
**boiserie Arnad** / Arnad wall panelling  
**basi armadio** / wardrobe base units

**finiture** / finishes

**nuvola** / nuvola  
**frassino chiaro** / frassino chiaro





**madia**  
sideboard

L / W 180 cm  
H / H 57 cm  
P / D 35,8 cm

**elementi** / elements  
**basi sospese** / wall-mounted base units

**finiture** / finishes  
**lavagna** / lavagna  
**vetro acidato** / etched glass

**tavolino Anversa** / Anversa occasional table  
**lavagna, frassino chiaro** - pag. 341 / lavagna, frassino chiaro - page 341  
**casellari Zip12** / Zip12 shelving units  
**nuvola** / nuvola







**composizione ingresso**  
entrance configuration

L / W 180 cm  
H / H 47,6 cm  
P / D 35,8 cm



**elementi / elements**

**piano sospeso con alzata sp. 5 cm**  
5 cm-thick wall-mounted top with upstand  
**basi sospese / wall-mounted base units**

**finiture / finishes**

**frassino chiaro / frassino chiaro**  
**lavagna / lavagna**

**tavolo Corby / Corby table**  
**frassino chiaro, lavagna - pag. 337**  
frassino chiaro, lavagna - page 337

**sedie Sneek imbottite / upholstered Sneek chairs**  
**spot T551, basamento R2 nero - pag. 343**  
spot T551, black R2 base - page 343



05a - 05b - 05c - **05d**

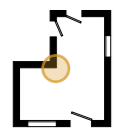

## Soggiorno

Living room

**parete attrezzata**  
wall system

L / W 445,1 cm  
H / H 221,3 cm  
P / D 61 cm



L / W 265,1 cm  
H / H 221,3 cm  
P / D 35,2 cm

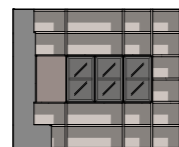

**elementi** / elements

**libreria a terra, sospesa e sovrapposta**  
floorstanding, wall-mounted and sit-on-top bookcase  
**basi a terra**  
floorstanding base units

**finiture** / finishes

**cashmere** / cashmere  
**basalto** / basalto  
**lavagna** / lavagna  
**rovere cotto** / rovere cotto  
**vetro fumé** / smoked glass

**sedia Sneek lounge** / Sneek lounge chair  
smooth T172, nero - pag. 347 / smooth T172, black - page 347

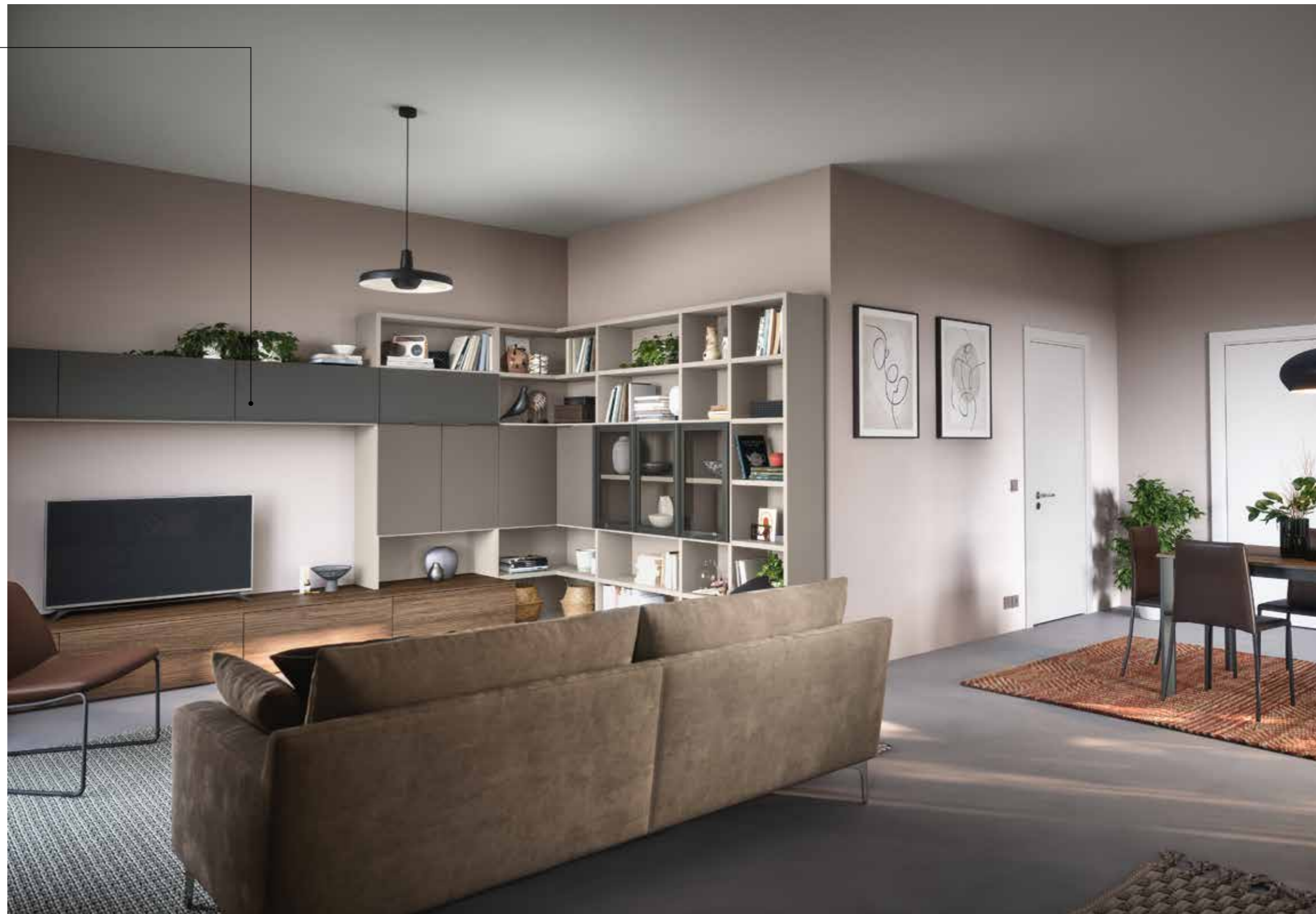



**sedie Nerja** / Nerja chairs  
**testa di moro** - pag. 343 / dark brown - page 343

**tavolo Nizza Large** / Nizza Large table  
**rovere cotto, lavagna** - pag. 338 / rovere cotto, lavagna - page 338

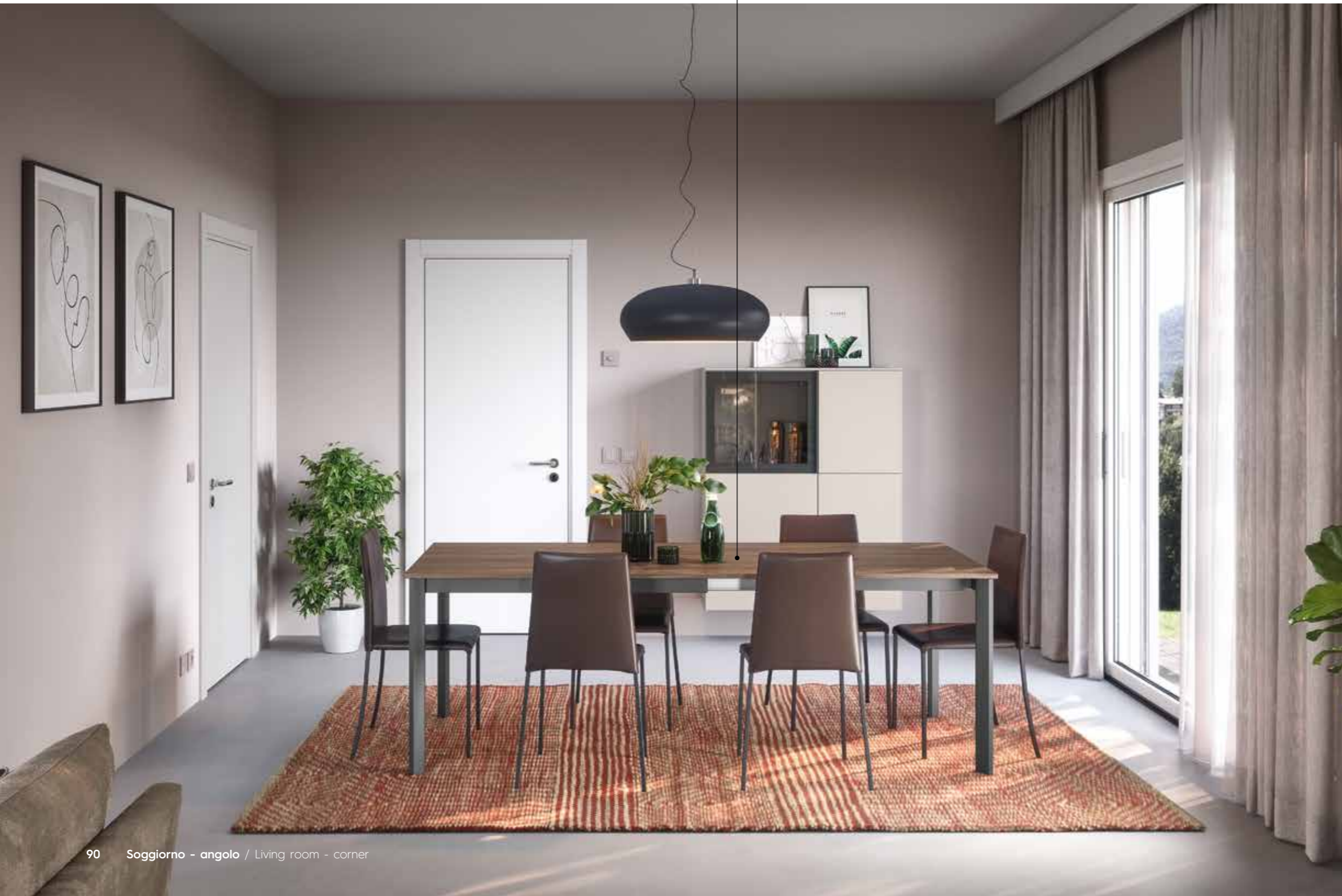

**madia**  
sideboard

L / W 105,3 cm  
H / H 129,3 cm  
P / D 35,8 cm



**elementi** / elements  
**pensili** / wall units

**finiture** / finishes

**cashmere** / cashmere  
**vetro fumé** / smoked glass  
**lavagna** / lavagna



**composizione ingresso**  
entrance configuration

L / W 240 cm  
H / H 172,9 cm  
P / D 45,8 cm

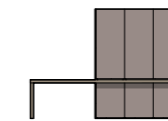

**elementi / elements**

**libreria a terra e sospesa**  
floorstanding and wall-mounted bookcase  
**piano in appoggio** / sit-on-top top

**finiture / finishes**

**basalto** / basalto  
**rovere cotto** / rovere cotto





# 06a - 06b - 06c - 06d

## Soggiorno

### Living room

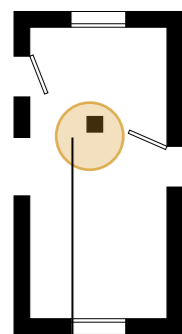

pilastro  
pillar

**La presenza di un pilastro nella zona giorno permette di suddividere l'ambiente, mantenendo la luminosità e lo stile contemporaneo che caratterizzano gli open space. Progettare in libertà si può, grazie all'ampia gamma di elementi e finiture.**

Having a pillar in the living space provides an opportunity to divide up the room, while still allowing light to flow through and retaining the contemporary style associated with an open-plan design. With an extensive range of elements and finishes to choose from, there's nothing to hold back your design creativity.







**parete attrezzata**  
wall system

L / W 384 cm  
H / H 239,6 cm  
P / D 45,8 cm

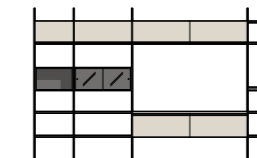

**elementi** / elements

**sistema Uniko** / Uniko system

**basi sospese** / wall-mounted base units

**pensili** / wall units

**finiture** / finishes

**frassino chiaro** / frassino chiaro

**lavagna** / lavagna

**vetro fumé** / smoked glass





**composizione ingresso**  
entrance configuration

|               |               |
|---------------|---------------|
| L / W 180 cm  | L / W 210 cm  |
| H / H 47,3 cm | H / H 77,9 cm |
| P / D 35,8 cm | P / D 46,6 cm |



**elementi** / elements

**basi a terra** / floorstanding base units  
**seduta imbottita** / padded seat

**finiture** / finishes

**frassino chiaro** / frassino chiaro  
**cemento** / cemento  
**cross T515** / cross T515





**mensole sp. 3 cm / 3 cm-thick shelves**  
**cemento / cemento**

**sedie Sneek imbottite / upholstered Sneek chairs**  
**spot T553, basamento R1 - pag. 343**  
spot T553, R1 base - page 343

**tavolo Nizza Large / Nizza Large table**  
**bianco - pag. 338 / bianco - page 338**



06a - **06b** - 06c - 06d

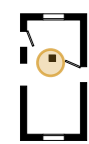

## Soggiorno

Living room

**parete attrezzata**  
wall system

L / W 360 cm  
H / H 185,2 cm  
P / D 45,8 cm



**elementi / elements**

**pensili / wall units**  
**casellari / shelving units**  
**boiserie Arnad / Arnad wall panelling**  
**mensola sp. 5 cm / 5 cm-thick shelf**  
**basi sospese / wall-mounted base units**

**finiture / finishes**

**cashmere / cashmere**  
**noce naturale / noce naturale**

**sedia Sneek lounge / Sneek lounge chair**  
**soft T566, nero - pag. 347**  
**soft T566, black - page 347**





**sedie Nerja** / Nerja chairs  
**testa di moro** - pag. 343 / dark brown - page 343  
**tavolo Corby** / Corby table  
 noce naturale, lavagna - pag. 337  
 noce naturale, lavagna - page 337

**composizione ingresso**  
 entrance configuration

L / W 183 cm  
 H / H 111,5 cm  
 P / D 37,4 cm

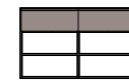

**elementi** / elements  
**libreria a terra**  
 floorstanding bookcase

**finiture** / finishes  
**basalto** / basalto



**sala da pranzo**  
 dining room

L / W 120 cm  
 H / H 221,3 cm  
 P / D 45,8 cm



**elementi** / elements



**pensili** / wall units

**basi a terra** / floorstanding base units

**finiture** / finishes

**basalto** / basalto

**vetro trasparente** / transparent glass

**lavagna** / lavagna





06a - 06b - **06c** - 06d

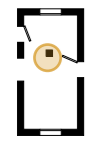

**Soggiorno**  
Living room



**parete attrezzata**  
wall system

L / W 390 cm  
H / H 112 cm  
P / D 45,8 cm

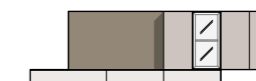

**elementi** / elements

**pannello porta TV** / TV mounting panel  
**basi sospese** / wall-mounted base units  
**pensili** / wall units

**finiture** / finishes

**cashmere** / cashmere  
**calce** / calce  
**rovere cotto** / rovere cotto  
**vetro trasparente** / transparent glass  
**lavagna** / lavagna

**composizione ingresso**  
entrance configuration

L / W 243 cm  
H / H 257,9 cm  
P / D 35,4 cm



**elementi / elements**

**libreria a terra** / floorstanding bookcase  
**pomoli appendiabiti** / clothes hanger knobs

**finiture / finishes**

**cashmere** / cashmere  
**calce** / calce  
**rovere cotto** / rovere cotto

**tavolino Orig** / Orig side table  
**rovere cotto, cashmere** - pag. 327  
rovere cotto, cashmere - page 327







**casellari Zip12** / Zip12 shelving units  
**rovere cotto** / rovere cotto

**composizione libreria**  
 bookcase configuration

L / W 243 cm  
 H / H 2579 cm  
 P / D 45,4 cm

**elementi** / elements  
**libreria a terra** / floorstanding bookcase



**finiture** / finishes  
**cashmere** / cashmere  
**vetro trasparente** / transparent glass  
**lavagna** / lavagna



**sedie Sneek** / Sneek chairs  
 J23, basamento R2 bianco - pag. 342 / J23, white R2 base - page 342

**tavolo Vigo** / Vigo table  
 vetro bianco, bianco - pag. 339 / white glass, bianco - page 339



06a - 06b - 06c - **06d**

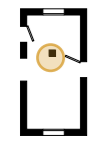

## Soggiorno

Living room



**sgabello Harlem** / Harlem stool  
TL32 - pag. 346 / TL32 - page 346

**comodino con ripiano** / bedside table with shelf  
olmo shade / olmo shade



**parete attrezzata**  
wall system

L / W 450,6 cm  
H / H 203,3 cm  
P / D 48,4 cm

L / W 180 cm  
H / H 68 cm  
P / D 60 cm

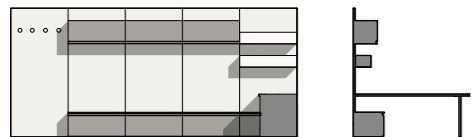

**elementi** / elements

**pensili** / wall units  
**mensole in metallo** / metal shelves  
**basi a terra** / floorstanding base units  
**piano scrivania sp. 3 cm con fianco**  
3 cm-thick desk top with side panel  
**boiserie Cover** / Cover wall panelling  
**pomoli appendiabiti** / clothes hanger knobs

**finiture** / finishes

**olmo shade** / olmo shade  
**intonaco** / intonaco  
**bianco** / bianco



**madia sospesa**  
wall-mounted sideboard

L / W 225 cm  
H / H 57,1 cm  
P / D 45,8 cm



**elementi** / elements

**basi sospese** / wall-mounted base units

**finiture** / finishes

**olmo shade** / olmo shade

**vetro fumé** / smoked glass

**lavagna** / lavagna

**sedie Nerja** / Nerja chairs  
bianco - pag. 343 / white - page 343

**scrivania sp. 1,2 e ø 145 cm** / desk 1,2 cm thick and ø 145 cm  
intonaco, bianco - pag. 334 / intonaco, bianco - page 334





# 07a - 07b

## Soggiorno

### Living room

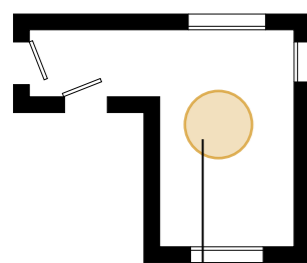

monocale  
studio apartment

**Spazi condivisi e intimi convivono anche nelle piccole metrature. La flessibilità delle composizioni permette di sfruttare in modo ingegnoso gli spazi del monocale, senza rinunciare allo stile e alla personalizzazione delle finiture.**

Shared, intimate spaces sit happily alongside each other even within a small floorplan. The flexibility of the configurations allows you to make clever use of the studio apartment's spaces, without skimping on style or custom finishes.







**parete attrezzata**  
wall system

L / W 445,6 cm  
H / H 294,5 cm  
P / D 122 - 219 cm

L / W 213 cm  
H / H 257,9 cm  
P / D 35,4 cm

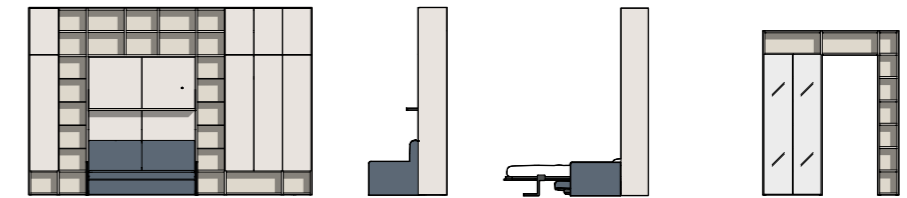

**elementi / elements**

**libreria a terra** / floorstanding bookcase

**libreria con letto ribaltabile, divano e mensola** / bookcase with drop-down bed, sofa and shelf

**cuscini per pannello** / panel cushions

**finiture / finishes**

**nuvola** / nuvola

**frassino chiaro** / frassino chiaro

**specchio chiaro** / light mirror

**thick T522** / thick T522

**bianco** / bianco





**parete attrezzata**  
wall system

L / W 390 cm  
H / H 108,6 cm  
P / D 45,8 - 169,4 cm



**elementi** / elements

**base sospesa con tavolo estraibile** / wall-mounted base unit with pull-out table

**pensili** / wall units

**casellario** / shelving unit

**basi sospese** / wall-mounted base units

**finiture** / finishes

**nuvola** / nuvola

**frassino chiaro** / frassino chiaro

**sedie Sneek** / Sneek chairs  
J00, basamento R2 bianco - pag. 342  
J00, white R2 base - page 342



07a - 07b

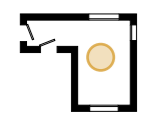

# Soggiorno

Living room

## composizione ingresso

entrance configuration

L / W 180 cm  
H / H 194 cm  
P / D 35,8 cm



### elementi / elements

**boiserie Arnad** / Arnad wall panelling  
**ganci appendiabiti** / coat hooks  
**specchio per boiserie** / mirror for wall panelling  
**basi a terra** / floorstanding base units

### finiture / finishes

**calce** / calce  
**rovere cotto** / rovere cotto  
**brunito** / bronze



## parete attrezzata

wall system

L / W 422,5 cm  
H / H 294,5 cm  
P / D 61 cm

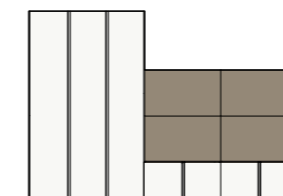

### elementi / elements

**armadio battente** / hinged door wardrobe  
**boiserie Arnad** / Arnad wall panelling  
**basi armadio** / wardrobe base units

### finiture / finishes

**bianco** / bianco  
**rovere cotto** / rovere cotto







**composizione libreria**  
bookcase configuration

L / W 430,6 cm  
H / H 294,5 cm  
P / D 40 - 193 - 219 cm

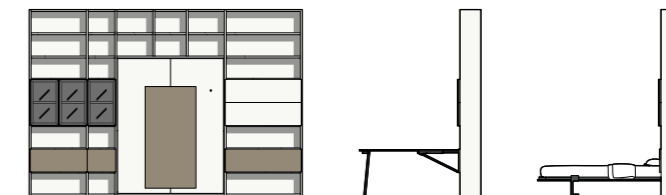

**elementi / elements**

**libreria a terra / floorstanding bookcase**  
**libreria con letto ribaltabile con tavolo / bookcase with drop-down bed with table**

**finiture / finishes**

**bianco / bianco**  
**rovere cotto / rovere cotto**  
**vetro fumé / smoked glass**  
**lavagna / lavagna**

**sedie Giant / Giant chairs**  
J00 - pag. 342 / J00 - page 342

# Personalizzare la camera da letto valorizzando lo spazio

Add a personal touch to a bedroom, making the most of the space

La camera si trasforma in un ambiente confortevole dove ogni elemento trova la giusta collocazione. La modularità delle composizioni arricchisce il progetto della stanza da letto, anche in presenza di particolari caratteristiche architettoniche.

The bedroom is transformed into a comfortable room where each element is perfectly placed. The configurations' modular design enhances the bedroom layout, even when working around specific architectural features.

## camera / bedroom

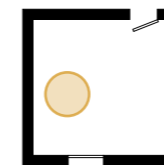

08a - pag. 130



08b - pag. 136



08c - pag. 140



08d - pag. 144



08e - pag. 148

## camera con nicchia / bedroom with recess

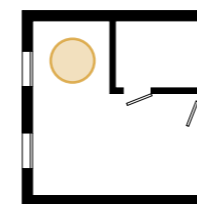

09a - pag. 152



09b - pag. 158



09c - pag. 162

## camera mansardata / attic bedroom

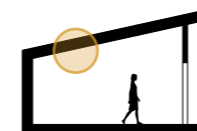

10a - pag. 166



10b - pag. 170



10c - pag. 172

## camera ad angolo / corner bedroom

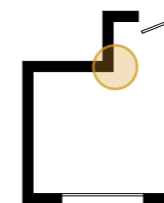

11a - pag. 176



11b - pag. 182



11c - pag. 186



08a - 08b - 08c - 08d - 08e

## Camera Bedroom

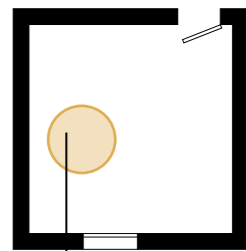

camera  
bedroom

**Gli elementi d'arredo trasformano lo spazio e definiscono in modo personale lo stile della camera da letto. Un progetto coordinato che strizza l'occhio alla razionalità mantenendo l'intimità della zona notte.**

Items of furniture transform the space and put a personal stamp on the style of the bedroom. A coordinated design that gives a nod to rationality while ensuring the bedroom still feels cosy and private.





**Turca R180 stonato** / rounded R180 platform bed  
**cemento** - pag. 309 / cemento - page 309

**composizione armadio**  
 wardrobe configuration

L / W 500 cm  
 H / H 109,8 cm  
 P / D 211,4 cm

L / W 262,3 cm  
 H / H 257,9 cm  
 P / D 61 cm

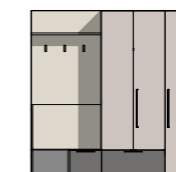

**elementi** / elements

- boiserie Arnad** / Arnad wall panelling
- armadio battente** / hinged door wardrobe
- basi armadio** / wardrobe base units
- mensola sp. 3 cm** / 3 cm-thick shelf
- ganci appendiabiti** / coat hooks

**finiture** / finishes

- cashmere** / cashmere
- cemento** / cemento
- frassino chiaro** / frassino chiaro
- brunito** / bronze
- cross T513** / cross T513



**mensole in metallo** / metal shelves  
**lavagna** / lavagna

**composizione home office**  
home office configuration

**L / W 300 cm**  
**H / H 799 cm**  
**P / D 61 cm**



**elementi** / elements

**basi sospese** / wall-mounted base units  
**piano in appoggio** / sit-on-top top

**finiture** / finishes

**cemento** / cemento  
**frassino chiaro** / frassino chiaro



**pouf Tokyo** / Tokyo ottoman  
TL32 - pag. 347 / TL32 - page 347

08a - **08b** - 08c - 08d - 08e



**Camera**  
Bedroom



**comodino Parigi** / Parigi bedside table  
sabbia, rovere cotto - pag. 326 / sabbia, rovere cotto - page 326

**letto Zurigo R18Z stondato** / rounded R18Z Zurigo bed  
rovere cotto - pag. 313 / rovere cotto - page 313



**composizione armadio**  
wardrobe configuration

L / W 500 cm  
H / H 257,9 cm  
P / D 60,6 cm



**elementi** / elements

**armadio battente** / hinged door wardrobe  
**basi armadio** / wardrobe base units  
**boiserie Arnad** / Arnad wall panelling  
**mensole sp. 3 cm** / 3 cm-thick shelves

**finiture** / finishes

**sabbia** / sabbia  
**rovere cotto** / rovere cotto



08a - 08b - **08c** - 08d - 08e



## Camera Bedroom

**letto Boston** / Boston bed  
soft T565, lavagna, fettuccia a contrasto CC10 - pag. 314  
soft T565, lavagna, CC10 contrasting piping - page 314



**comodino**  
bedside table

L / W 120 cm  
H / H 43,5 cm  
P / D 45,8 cm



**elementi** / elements

**basi sospese** / wall-mounted base units  
**boiserie Arnad** / Arnad wall panelling  
**pedana h 3,7 cm** / plinth H 3,7 cm

**finiture** / finishes

**lavagna** / lavagna







**composizione armadio**  
wardrobe configuration

L / W 491 cm  
H / H 257,9 cm  
P / D 65,4 cm

L / W 220,4 cm  
H / H 257,9 cm  
P / D 60 cm

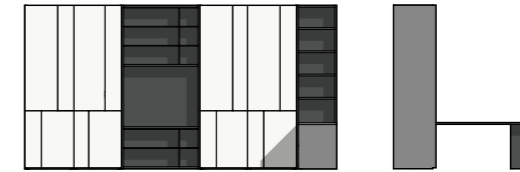

**elementi / elements**

**armadio scorrevole** / sliding door wardrobe

**libreria a terra** / floorstanding bookcase

**elementi Sudoku** / Sudoku units

**piano scrivania sp. 3 cm con fianco** / 3 cm-thick desk top with side panel

**finiture / finishes**

**bianco** / bianco

**lavagna** / lavagna

**sedia Cannes** / Cannes chair  
TL36 - pag. 345 / TL36 - page 345



08a - 08b - 08c - **08d** - 08e

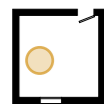

## Camera Bedroom



**sedia Sneek imbottita** / upholstered Sneek chair  
smooth T167, basamento R2 bianco - pag. 343  
smooth T167, white R2 base - page 343

### composizione armadio wardrobe configuration

L / W 500 cm  
H / H 257,9 cm  
P / D 60,6 cm

L / W 256 cm  
H / H 257,9 cm  
P / D 60,6 cm

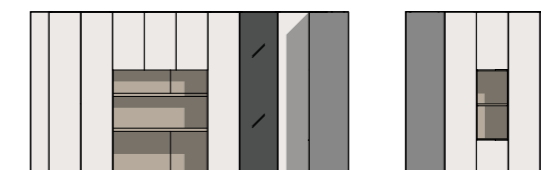

### elementi / elements

**armadi battenti** / hinged door wardrobes

**armadio ponte** / bridging wardrobe

**boiserie Arnad** / Arnad wall panelling

**mensola sp. 5 cm** / 5 cm-thick shelf

**piano sospeso con alzata sp. 5 cm** / 5 cm-thick wall-mounted top with upstand

**terminale trapezio** / trapezium end unit

### finiture / finishes

**calce** / calce

**noce naturale** / noce naturale

**bianco** / bianco

**specchio brunito** / tinted mirror





**favolino Orig** / Orig side table  
noce naturale, bianco - pag. 327  
noce naturale, bianco - page 327

**letto Thika** / Thika bed  
thick T528 - pag. 316 / thick T528 - page 316

**comodino Atene** / Atene bedside table  
noce naturale - pag. 324 / noce naturale - page 324



08a - 08b - 08c - 08d - **08e**

## Camera Bedroom

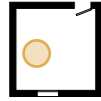

**composizione armadio**  
wardrobe configuration

L / W 491,6 cm  
H / H 257,9 cm  
P / D 65,4 cm

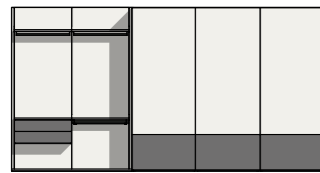

**elementi / elements**

**cabina cremagliera** / slotted rail walk-in closet  
**armadio scorrevole** / sliding door wardrobe  
**pedana h 3,7 cm** / plinth H 3,7 cm

**finiture / finishes**

**olmo shade** / olmo shade  
**cemento** / cemento  
**bianco** / bianco

**comodino con ripiano**  
bedside table with shelf  
**olmo shade** / olmo shade







**letto Mostar R120** / R120 Mostar bed  
**olmo shade** - pag. 311 / olmo shade - page 311

**comodino Bilbao** / Bilbao bedside table  
**cemento** - pag. 324 / cemento - page 324

**sedia Sneek lounge** / Sneek lounge chair  
**cross T505, bianco** - pag. 347 / cross T505, white - page 347

09a - 09b - 09c

## Camera Bedroom

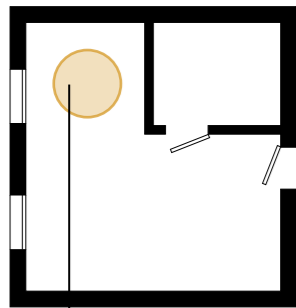

con nicchia  
with recess

La presenza di una nicchia nella camera è utile per organizzare la parete in modo funzionale: la composizione, grazie alla versatilità degli elementi, trasforma gli spazi donando alla stanza carattere e razionalità.

Having a recess in the bedroom is useful for making more functional use of the wall: with the versatility of the various elements, the configuration transforms the spaces, adding character and a touch of rationality to the room.







**composizione armadio**  
wardrobe configuration

L / W 220 cm  
H / H 257,9 cm  
P / D 60,6 cm

L / W 234,8 cm  
H / H 257,9 cm  
P / D 60,6 cm

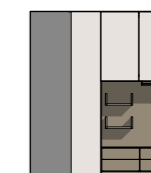
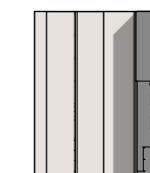

**elementi / elements**

**armadio battente** / hinged door wardrobe

**armadio ponte con fianco metallico**

bridging wardrobe with metal side panel

**boiserie Cover** / Cover wall panelling

**componenti Cover** / Cover components

**basi in appoggio** / sit-on-top base units

**pedana h 5,7 cm** / plinth H 5,7 cm

**finiture / finishes**

**nuvola** / nuvola

**rovere cotto** / rovere cotto



**letto Suez R70 stondato, cuffia Ennis**  
 rounded R70 Suez bed, Ennis headboard cover  
 nuvola, spot T553 - pag. 311 / nuvola, spot T553 - page 311

**base a terra** / floorstanding base unit  
 nuvola - pag. 280 / nuvola - page 280

**contenitore appendiabiti Ginevra**  
 Ginevra coat cupboard  
 nuvola / nuvola



**panca scendiletto** / bed end bench  
 noce naturale / noce naturale  
**seduta imbottita** / padded seat  
 cross T515 / cross T515



09a - **09b** - 09c

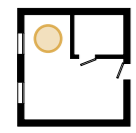

**Camera**  
Bedroom



**composizione cabina armadio**  
walk-in closet configuration

|                       |                       |
|-----------------------|-----------------------|
| <b>L / W 205,5 cm</b> | <b>L / W 220,2 cm</b> |
| <b>H / H 257,9 cm</b> | <b>H / H 257,9 cm</b> |
| <b>P / D 50,8 cm</b>  | <b>P / D 50,8 cm</b>  |

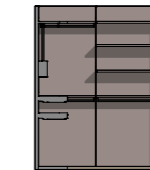

**elementi / elements**

**cabina cremagliera / slotted rail walk-in closet**  
**pedane sp. 5,7 cm / plinths 5,7 cm thick**

**finiture / finishes**

**basalto / basalto**  
**rovere cotto / rovere cotto**

**chiusura scorrevole L 220 x H 270 cm**  
sliding closing system W 220 x H 270 cm  
**vetro fumé, grafite / smoked glass, grafite**

**Turca imbottita** / padded platform bed  
spot T544 - pag. 309 / spot T544 - page 309

**testiera Cardiff, cuffia Singer, luci direzionali**  
Cardiff headboard, Singer headboard cover, directional lights  
rovere cotto, spot T544 - pag. 317 / rovere cotto, spot T544 - page 317



**comò Londra**  
Londra chest of drawers  
rovere cotto - pag. 325  
rovere cotto - page 325

**casellari Zip12** / Zip12 shelving units  
rovere cotto / rovere cotto





09a - 09b - **09c**



## Camera Bedroom

### composizione armadio wardrobe configuration

L / W 207 cm    L / W 444 cm  
H / H 257,9 cm    H / H 257,9 cm  
P / D 101,5 cm    P / D 101,5 cm

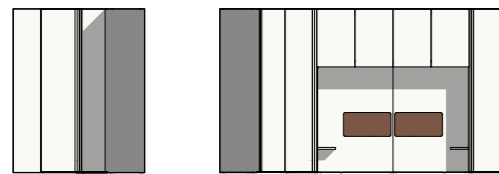

### elementi / elements

**terminale libreria** / bookcase end unit  
**armadio battente** / hinged door wardrobe  
**angolo spogliatoio** / corner walk-in closet  
**armadio ponte** / bridging wardrobe  
**ripiani sagomati** / shaped shelves  
**cuscini per pannello** / panel cushions

### finiture / finishes

**bianco** / bianco  
**soft T566** / soft T566



**Turca R120** / R120 platform bed  
**frassino chiaro** - pag. 309 / frassino chiaro - page 309



**composizione home office**  
home office configuration

L / W 210 cm    L / W 213 cm  
H / H 180 cm    H / H 74,9 cm  
P / D 61 cm    P / D 45,4 cm

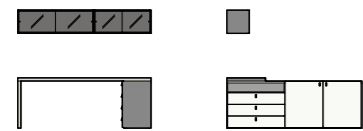

**elementi / elements**

**pensili / wall units**  
**piano in appoggio sp. 5 cm / 5 cm-thick sit-on-top top**  
**libreria a terra / floorstanding bookcase**

**finiture / finishes**

**bianco / bianco**  
**frassino chiaro / frassino chiaro**  
**vetro fumé / smoked glass**

**sedia Nice / Nice chair**  
**TL31 - pag. 345 / TL31 - page 345**





# 10a - 10b - 10c

## Camera Bedroom



**Una cabina armadio a vista progettata per donare carattere e versatilità alla camera mansardata. La flessibilità degli elementi modulabili in altezza permette di progettare un guardaroba organizzato anche in presenza di una parete ribassata.**  
An open walk-in closet designed to add character and versatility to an attic bedroom. The flexibility offered by the elements' different module heights means you can design an organized wardrobe even when dealing with a lower ceiling.

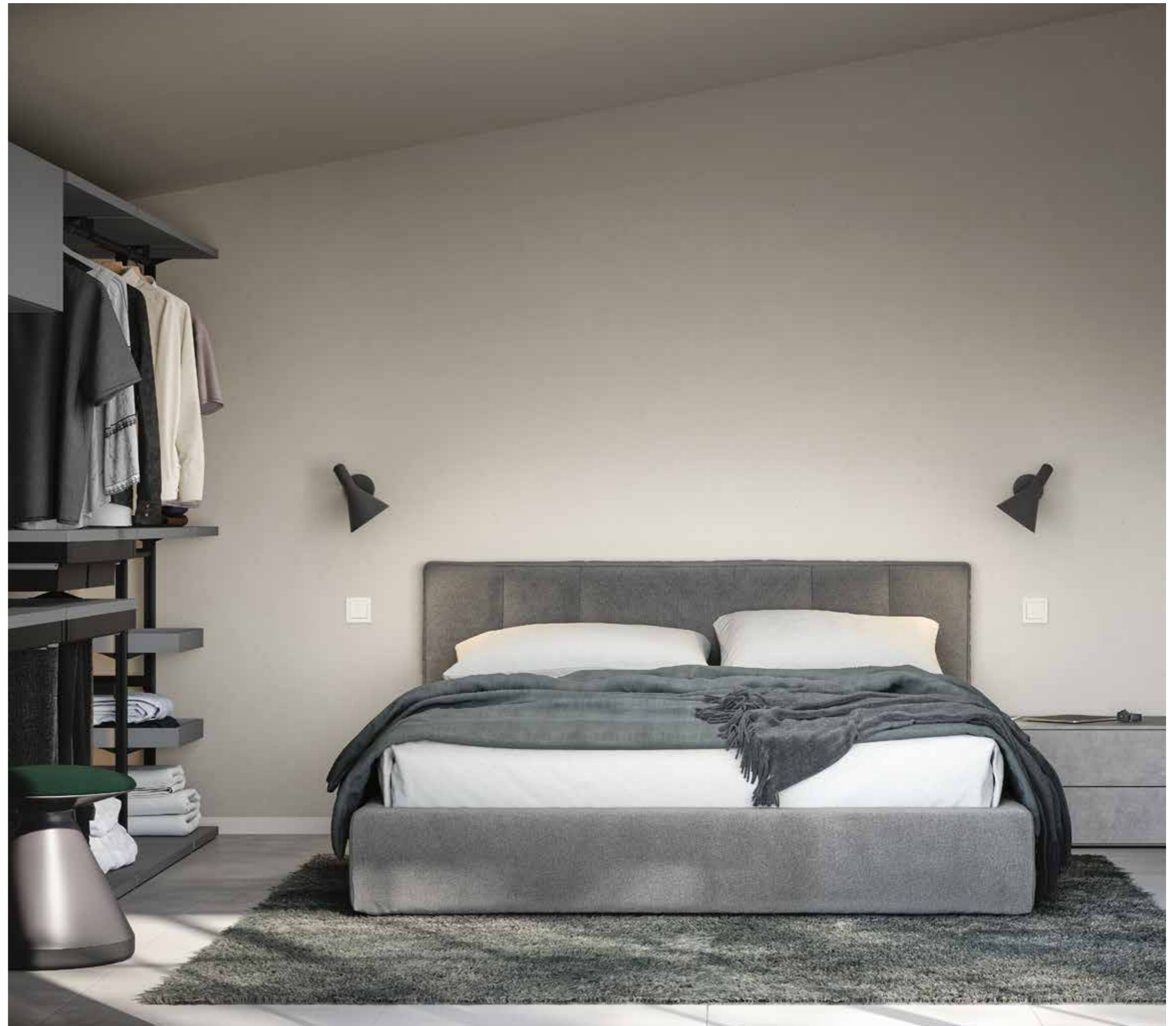



**pouf Tokyo / Tokyo ottoman**  
TL35 - pag. 347 / TL35 - page 347

**composizione cabina armadio**  
walk-in closet configuration

L / W 371,2 cm  
H / H 203 cm  
P / D 45,8 cm

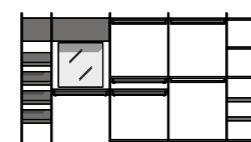

**elementi / elements**  
sistema Uniko / Uniko system  
specchio / mirror  
pedana h 3,7 cm / plinth H 3,7 cm

**finiture / finishes**  
cemento / cemento  
lavagna / lavagna

**letto York / York bed**  
soft T564 - pag. 316 / soft T564 - page 316



**composizione basi a terra**  
floorstanding base units configuration

L / W 115,2 cm    L / W 245,4 cm  
H / H 39,5 cm    H / H 39,5 cm  
P / D 45,8 cm    P / D 45,8 cm



**elementi / elements**  
basi a terra / floorstanding base units

**finiture / finishes**  
intonaco / intonaco





10a - **10b** - 10c

**Camera**  
Bedroom

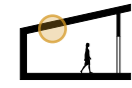

letto Lagos R290 stondato / rounded R290 Lagos bed  
basalto, thick T529 - pag. 310 / basalto, thick T529 - page 310



**comodino Bilbao** / Bilbao bedside table  
noce naturale, basalto - pag. 324  
noce naturale, basalto - page 324

**mensole in metallo** / metal shelves  
basalto / basalto

**pouf Tokyo** / Tokyo ottoman  
TL36 - pag. 347 / TL36 - page 347

**composizione armadio**  
wardrobe configuration

L / W 422,8 cm  
H / H 200 + 291,5 cm  
P / D 60,6 cm

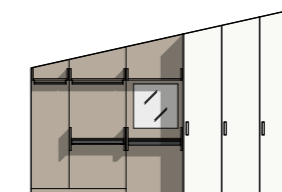

**elementi** / elements  
**armadio battente** / hinged door wardrobe  
**boiserie Cover** / Cover wall panelling  
**componenti Cover** / Cover components  
**specchio per boiserie** / mirror for wall panelling  
**pedana h 8,7 cm** / plinth H 8,7 cm

**finiture** / finishes

**bianco** / bianco  
**noce naturale** / noce naturale

10a - 10b - **10c**

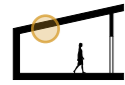

## Camera Bedroom

**composizione armadio**  
wardrobe configuration

L / W 425,5 cm  
H / H 200 + 290 cm  
P / D 60,6 cm

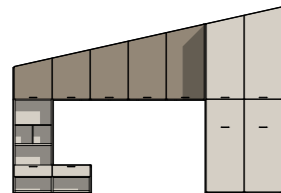

**elementi / elements**

**libreria a terra** / floorstanding bookcase  
**elemento Sudoku** / Sudoku unit  
**libreria sospesa** / wall-mounted bookcase  
**armadio battente** / hinged door wardrobe

**finiture / finishes**

**canapa** / canapa  
**rovere cotto** / rovere cotto

**letto Jerez R18Z stondato** / rounded R18Z Jerez bed  
**canapa, thick T521 - pag. 315** / canapa, thick T521 - page 315







**scrivania sagomata con fianco sp. 5 cm**  
shaped desk with 5 cm-thick side panel  
**canapa - pag. 328** / canapa - page 328

**base sospesa** / wall-mounted base unit  
**canapa - pag. 280** / canapa - page 280

**sedia Sneek imbottita** / upholstered Sneek chair  
**smooth T152, basamento R1 - pag. 343**  
smooth T152, R1 base - page 343

# 11a - 11b - 11c

## Camera Bedroom

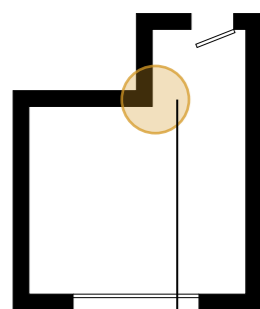

ad angolo  
corner

**Una soluzione progettuale per la camera con forma irregolare: lo spazio della parete ad angolo viene organizzato in modo funzionale, ogni elemento trova infatti la giusta collocazione, per un ambiente comodo e piacevole da vivere.**

A design solution for an irregularly shaped bedroom: the space on the corner wall jutting into the room is organized in a functional way, so each element is perfectly placed, for a comfortable room that's a joy to spend time in.







**composizione armadio**  
wardrobe configuration

L / W 313 cm  
H / H 257,9 cm  
P / D 60,6 cm

L / W 201,8 cm  
H / H 257,9 cm  
P / D 60,6 cm



**elementi / elements**

**cabina a spalla**

walk-in closet system with load-bearing side panels

**armadio battente / hinged door wardrobe**

**finiture / finishes**

**olmo shade / olmo shade**

**bianco / bianco**

**basalto / basalto**

**specchio chiaro / light mirror**



**sedia Cannes** / Cannes chair  
 TL32 - pag. 345 / TL32 - page 345

**composizione home office**  
 home office configuration

L / W 270 cm  
 H / H 155 cm  
 P / D 61 cm

**elementi** / elements

**basi sospese** / wall-mounted base units  
**piano sospeso con alzata sp. 5 cm**  
 5 cm-thick wall-mounted top with upstand  
**casellari Zip12** / Zip12 shelving units

**finiture** / finishes

**basalto** / basalto  
**olmo shade** / olmo shade

**comodino Oslo** / Oslo bedside table  
 basalto - pag. 326 / basalto - page 326

**letto Kora** / Kora bed  
 spot T549 - pag. 315 / spot T549 - page 315

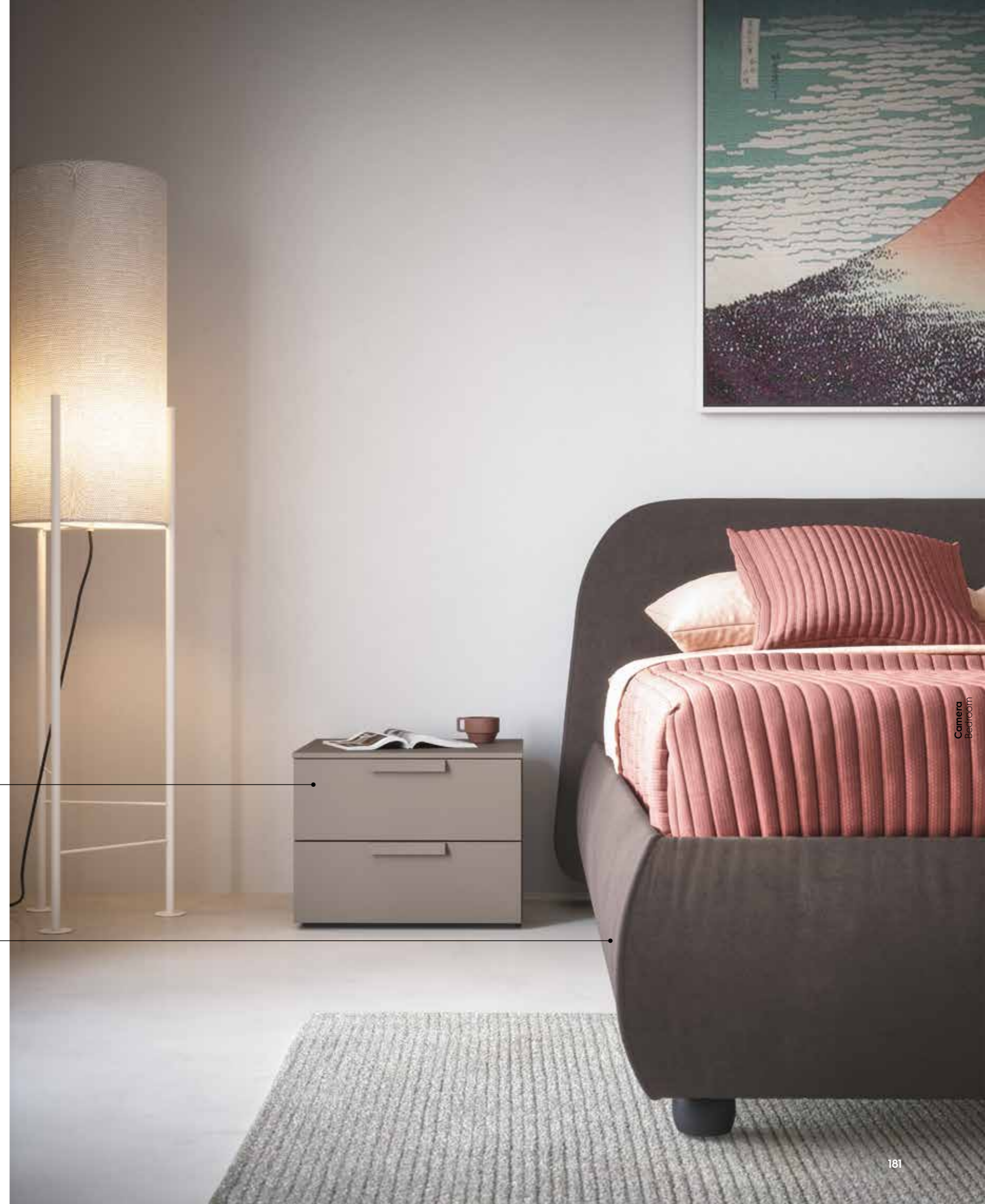



11a - **11b** - 11c

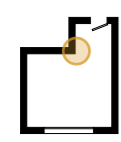

**Camera**  
Bedroom

**mensole ad L** / L-shaped shelves  
canapa / canapa



**comodini Praga** / Praga bedside tables  
canapa - pag. 327 / canapa - page 327

**letto Este R180 stondato** / rounded R180 Este bed  
noce naturale, lavagna - pag. 310 / noce naturale, lavagna - page 310





**composizione armadio**  
wardrobe configuration

L / W 452,5 cm  
H / H 257,9 cm  
P / D 60,6 cm

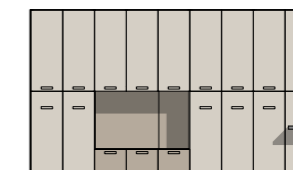

**elementi** / elements

**armadio battente** / hinged door wardrobe  
**armadio ponte** / bridging wardrobe  
**basi armadio** / wardrobe base units  
**boiserie Arnad** / Arnad wall panelling

**finiture** / finishes

**canapa** / canapa  
**noce naturale** / noce naturale

**piano sospeso con alzata sp. 5 cm** / 5 cm-thick wall-mounted top with upstand  
noce naturale - pag. 332 / noce naturale - page 332

**sedia Sneek imbottita** / upholstered Sneek chair  
spot T541, basamento R2 bianco - pag. 343 / spot T541, white R2 base - page 343



11a - 11b - **11c**

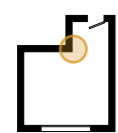

## Camera Bedroom



**comodino con ripiano**  
bedside table with shelf  
**rovere cotto / rovere cotto**

### **composizione armadio** wardrobe configuration

L / W 455 cm  
H / H 109,8 cm  
P / D 211,3 cm

L / W 302,5 cm  
H / H 257,9 cm  
P / D 64,2 cm

L / W 153 cm  
H / H 257,9 cm  
P / D 48,6 cm

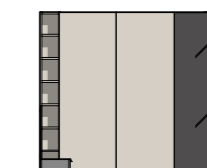

### **elementi / elements**

**boiserie Arnad** / Arnad wall panelling  
**libreria a terra** / floorstanding bookcase  
**armadio scorrevole** / sliding door wardrobe

### **finiture / finishes**

**canapa** / canapa  
**rovere cotto** / rovere cotto  
**lavagna** / lavagna  
**specchio brunito** / tinted mirror  
**thick T522** / thick T522



**comò Bonn** / Bonn chest of drawers  
 rovere cotto, canapa - pag. 325  
 rovere cotto, canapa - page 325

**casellari con crociera**  
 shelving units with pigeon hole  
 canapa, rovere cotto - pag. 280  
 canapa, rovere cotto - page 280

**Turca R18Z stondato** / rounded R18Z platform bed  
 canapa - pag. 309 / canapa - page 309

**base in appoggio su pedana h 5,7 cm** / base unit sitting on plinth H 5,7 cm  
 canapa, rovere cotto - pag. 280 / canapa, rovere cotto - page 280

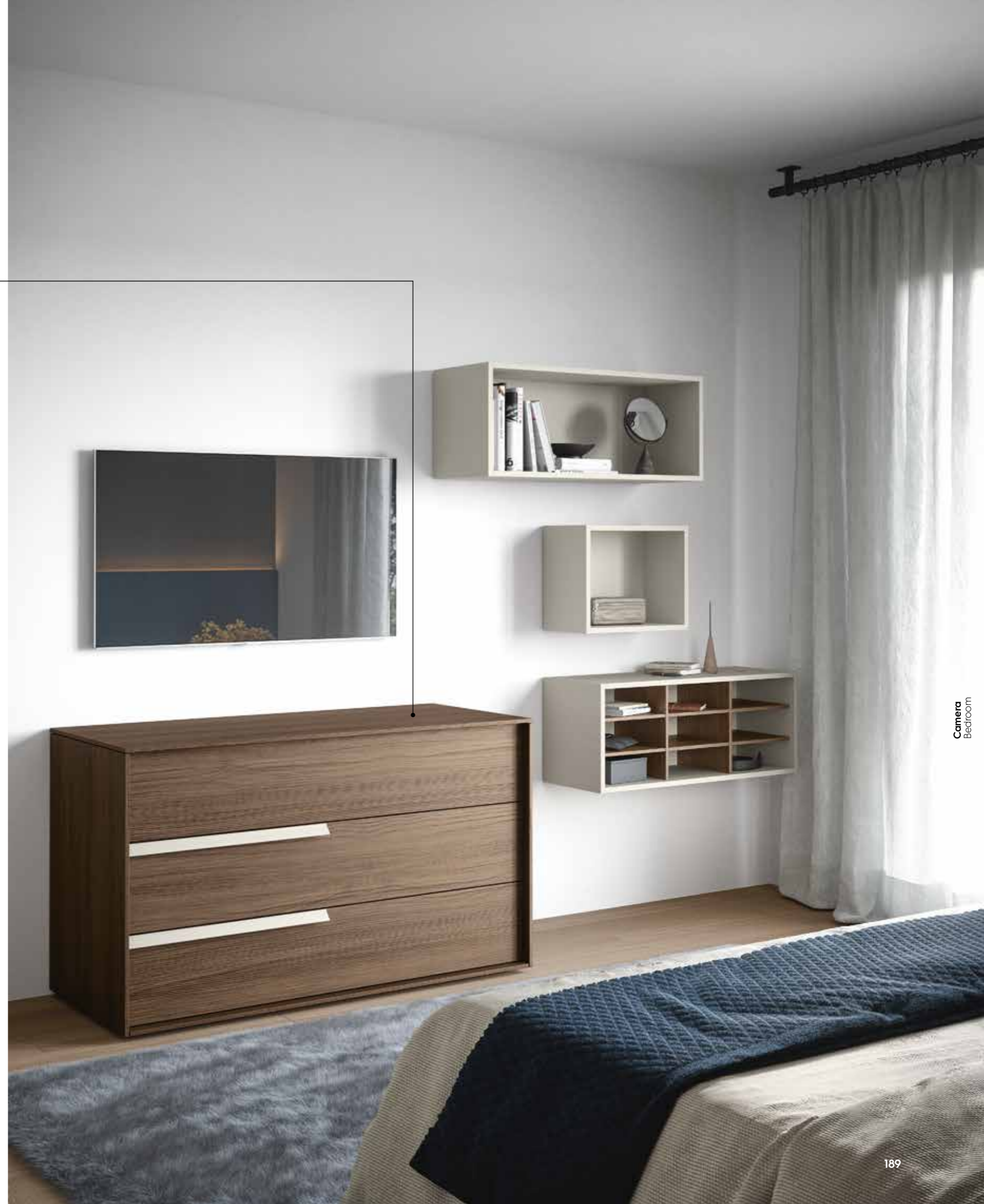



# Sempre in ordine

Keeping spaces tidy

## lavanderia / laundry



12a - pag. 192



12b - pag. 196



12c - pag. 200



12d - pag. 204

## lavanderia mansardata / attic laundry



13a - pag. 208



13b - pag. 212



13c - pag. 216

**La lavanderia è un ambiente che richiede un'organizzazione puntuale degli spazi. Soluzioni d'arredo modulari rendono funzionale l'ambiente di servizio, adattandosi al progetto architettonico. Un'ampia gamma di elementi salvaspazio.**

The laundry is a room that requires spaces to be properly organized. Modular furniture solutions make utility areas functional, adapting to fit within the architectural envelope. An extensive range of space-saving items.

## lavanderia in nicchia / laundry in a recess



14a - pag. 218



14b - pag. 222



14c - pag. 224

# 12a - 12b - 12c - 12d

## Lavanderia Laundry

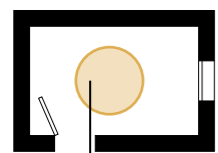

lavanderia  
laundry

**Una stanza adibita a lavanderia dove riporre gli accessori dedicati a pulizie e bucato. Uno spazio organizzato e sempre ordinato, grazie all'ampia flessibilità compositiva degli elementi d'arredo.**  
A room set up as a laundry for storing cleaning and laundry tools. A space kept tidy and organized thanks to the impressive modular flexibility of the items of furniture.







**composizione lavanderia**  
laundry configuration

L / W 315,6 cm  
H / H 257,9 cm  
P / D 73,3 cm

L / W 205,6 cm  
H / H 257,9 cm  
P / D 61 cm

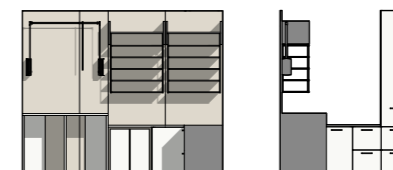

**elementi / elements**

**boiserie Cover** / Cover wall panelling

**componenti Cover** / Cover components

**piano di lavoro** / worktop

**basi armadio** / wardrobe base units

**armadio battente** / hinged door wardrobe

**cesti portabiancheria su ruote** / laundry baskets on castors

**finiture / finishes**

**frassino chiaro** / frassino chiaro

**bianco** / bianco



12a - **12b** - 12c - 12d

# Lavanderia



Laundry



**composizione lavanderia**  
laundry configuration

L / W 313 cm  
H / H 257,9 cm  
P / D 60,6 cm

L / W 206 cm  
H / H 92,5 cm  
P / D 61 cm

**elementi / elements**

- armadio battente**  
hinged door wardrobe
- armadio ponte** / bridging wardrobe
- ripiani sagomati** / shaped shelves
- pedana h 3,7 cm** / plinth H 3,7 cm
- piano scrivania sp. 3 cm con fianco**  
3 cm-thick desk top with side panel

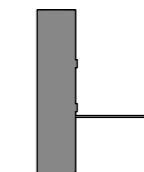
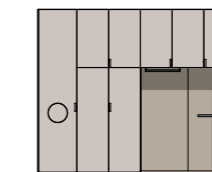

**finiture / finishes**

- cashmere** / cashmere
- noce naturale** / noce naturale
- bianco** / bianco





12a - 12b - **12c** - 12d

# Lavanderia Laundry



## composizione lavanderia laundry configuration

L / W 318 cm  
H / H 221,3 cm  
P / D 45,4 cm



### elementi / elements

libreria con gambe metalliche e sospesa  
bookcase with metal legs and wall mounted

### finiture / finishes

olmo shade / olmo shade  
cemento / cemento  
lavagna / lavagna  
titanio / titanio







**composizione portascarpe**  
shoe rack configuration

L / W 183 cm  
H / H 148,1 cm  
P / D 43 cm



**elementi** / elements  
**libreria con gambe metalliche**  
bookcase with metal legs

**finiture** / finishes  
**cemento** / cemento  
**lavagna** / lavagna

12a - 12b - 12c - **12d**  
**Lavanderia**  
 Laundry



**composizione lavanderia**  
 laundry configuration

L / W 255 cm  
 H / H 200 cm  
 P / D 61 cm

**elementi / elements**

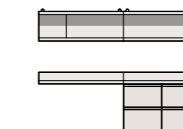

**boiserie Arnad / Arnad wall panelling**  
**mensole sp. 5 cm / 5 cm-thick shelves**  
**piani sospesi con alzata sp. 5 cm**  
 5 cm-thick wall-mounted top with upstand  
**basi sospese / wall-mounted base units**

**finiture / finishes**

**calce / calce**  
**nuvola / nuvola**





**composizione lavanderia**  
laundry configuration

L / W 182,5 cm  
H / H 237,6 cm  
P / D 51,8 cm

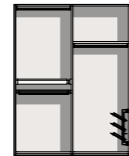

**elementi** / elements  
**cabina armadio** / walk-in closet

**finiture** / finishes  
**calce** / calce  
**nuvola** / nuvola





# 13a - 13b - 13c

## Lavanderia

### Laundry



**La presenza del sottotetto viene risolta sfruttando l'ampia modularità degli elementi, che consente di organizzare al meglio lo spazio disponibile. Un ambiente di servizio organizzato grazie a soluzioni d'arredo che ottimizzano l'ingombro.**

The issue of dealing with a sloping ceiling is addressed by leveraging the elements' extensive range of module options, enabling the available space to be organized in the best possible way. A utility area turned into an organized space thanks to furniture solutions that make the best of a small footprint.







**composizione lavanderia**  
laundry configuration

L / W 278 cm  
H / H 164,7 ÷ 268,2 cm  
P / D 46,3 cm

L / W 215,7 cm  
H / H 164,7 cm  
P / D 61 cm

L / W 280 cm  
H / H 167,7 cm  
P / D 61 cm

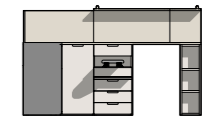
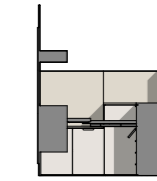
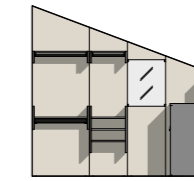

**elementi / elements**

- boiserie Cover** / Cover wall panelling
- componenti Cover** / Cover components
- specchio per boiserie** / mirror for wall panelling
- boiserie Arnad** / Arnad wall panelling
- mensola sp. 3 cm** / 3 cm-thick shelf
- basi armadio** / wardrobe base units
- libreria a terra** / floorstanding bookcase

**finiture / finishes**

- frassino chiaro** / frassino chiaro
- nuvola** / nuvola



13a - **13b** - 13c

 **Lavanderia**  
Laundry

**composizione lavanderia**  
laundry configuration

L / W 279 cm  
H / H 162 + 257,9 cm  
P / D 45,8 cm

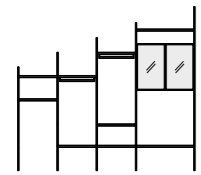

**elementi** / elements  
**sistema Uniko** / Uniko system  
**pensile** / wall unit

**finiture** / finishes

**lavagna** / lavagna  
**specchio chiaro** / light mirror





**composizione lavanderia**  
laundry configuration

L / W 270 cm  
H / H 122,7 cm  
P / D 61 cm

...



**elementi / elements**

**portavaligie** / luggage shelf  
**seduta imbottita** / padded seat  
**basi a terra** / floorstanding base units  
**ganci appendiabiti** / coat hooks

**finiture / finishes**

**calce** / calce  
**cross T512** / cross T512  
**grafite** / grafite  
**lavagna** / lavagna  
**brunito** / bronze



13a - 13b - **13c**

# Lavanderia Laundry



### composizione lavanderia laundry configuration

L / W 278 cm  
H / H 164 ÷ 267,5 cm  
P / D 35,2 cm

L / W 215,6 cm  
H / H 94,7 cm  
P / D 65 cm

L / W 278 cm  
H / H 164 ÷ 267,5 cm  
P / D 35,2 cm

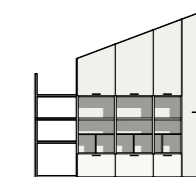
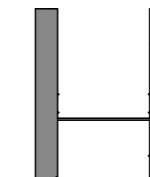
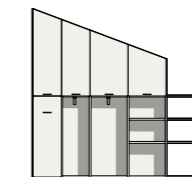

### elementi / elements

libreria a terra / floorstanding bookcase

elementi Sudoku / Sudoku units

pannello orizzontale sp. 3 cm / 3 cm-thick horizontal panel

### finiture / finishes

olmo shade / olmo shade

bianco / bianco



# 14a - 14b - 14c

## Lavanderia

### Laundry



**Progettare una nicchia dedicata alla lavanderia, un piccolo ambiente organizzato dove ogni accessorio trova la giusta collocazione. Una soluzione che permette di avere una piccola lavanderia pratica ma discreta.**

Designing a recess to house a laundry, a small organized alcove where all your accessories find a proper home. A solution that allows you to have a small laundry that's at once practical and discreet.





**composizione lavanderia**  
laundry configuration

|                |                |
|----------------|----------------|
| L / W 241,8 cm | L / W 240 cm   |
| H / H 270 cm   | H / H 257,9 cm |
| P / D 10,3 cm  | P / D 50,8 cm  |

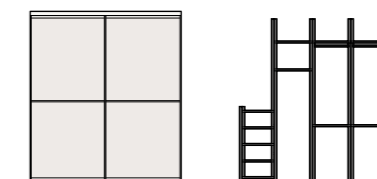

**elementi / elements**

**chiusura scorrevole / sliding closing system**  
**cabina cremagliera / slotted rail walk-in closet**

**finiture / finishes**

**cemento / cemento**  
**calce / calce**  
**bianco / bianco**





14a - **14b** - 14c  
**Lavanderia**  
Laundry

**composizione lavanderia**  
laundry configuration

L / W 241 cm  
H / H 257,9 cm  
P / D 72,2 cm

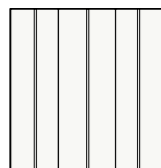

**elementi / elements**

**armadio Service battente**  
hinged door Service cupboard  
**cesti portabiancheria su ruote**  
laundry baskets on castors

**finiture / finishes**

**bianco / bianco**



14a - 14b - **14c**

**Lavanderia**

Laundry



**composizione lavanderia**  
laundry configuration

L / W 242,5 cm  
H / H 257,9 cm  
P / D 80 cm

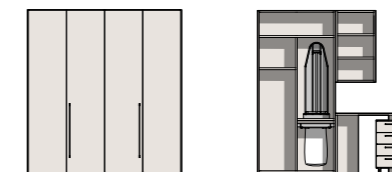

**elementi** / elements

**armadio pieghevole** / folding door wardrobe  
**chiusura pieghevole** / folding closing system  
**libreria sospesa** / wall-mounted bookcase  
**piano di lavoro** / worktop  
**cassettiera con ruote** / drawer unit on castors

**finiture** / finishes

**nuvola** / nuvola  
**nicel** / nichel



# Ambienti di servizio funzionali e organizzati

Functional and  
organized utility areas

## dispensa / pantry



15a - pag. 228



15b - pag. 232



15c - pag. 234

## garage / garage

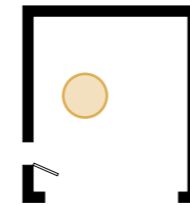

16a - pag. 236



16b - pag. 240



16c - pag. 242

## ripostiglio / walk-in cupboard



17a - pag. 244



17b - pag. 248



17c - pag. 250

Ottimizzare un progetto, significa anche sfruttare al meglio gli ambienti di servizio. Dispensa, garage, ripostiglio e corridoio diventano spazi funzionali dall'ampio potere contenitivo, da gestire al meglio grazie alle diverse soluzioni compositive.

Optimizing an interior layout is also a question of exploiting utility areas to the full. Pantry, garage, walk-in cupboard and corridor become functional spaces offering tonnes of storage; spaces that can be put together to best effect with different configurations.

## disimpegno / vestibule

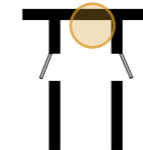

18a - pag. 252



18b - pag. 256



18c - pag. 258

# 15a - 15b - 15c

## Dispensa

### Pantry

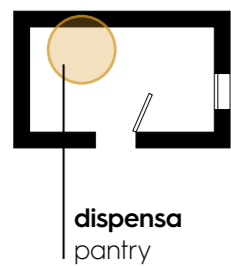

**Disporre di un ambiente dedicato alle scorte alimentari diventa strategico soprattutto per chi ha poco tempo. Anche in presenza di spazi ridotti la modularità degli elementi permette di trovare la giusta collocazione a ogni prodotto.**

Having a room just for food storage is a strategic plus, especially for the time-poor. Even when dealing with small spaces, the elements' modular design means you can ensure that there's an appropriate place for every product.







**composizione dispensa**  
pantry configuration

L / W 202,3 cm  
H / H 255,9 cm  
P / D 51,8 cm

L / W 272,3 cm  
H / H 255,9 cm  
P / D 51,8 cm

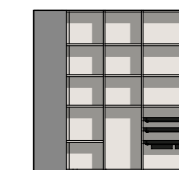
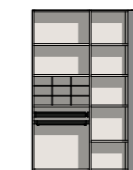

**elementi** / elements

**cabina armadio** / walk-in closet

**finiture** / finishes

**nuvola** / nuvola

15a - **15b** - 15c

**Dispensa**



Pantry



**composizione dispensa**  
pantry configuration

|                |                |
|----------------|----------------|
| L / W 186 cm   | L / W 276 cm   |
| H / H 257,9 cm | H / H 257,9 cm |
| P / D 47,6 cm  | P / D 44,5 cm  |

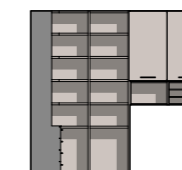

**elementi / elements**

**cabina a spalla**

walk-in closet system with load-bearing side panels

**libreria sospesa / wall-mounted bookcase**

**casellari / shelving units**

**finiture / finishes**

**cashmere / cashmere**

**titanio / titanio**



15a - 15b - **15c**

# Dispensa Pantry



## composizione dispensa pantry configuration

L / W 275,4 cm    L / W 200,6 cm  
H / H 239,6 cm    H / H 77,9 cm  
P / D 61 cm        P / D 61 cm



## elementi / elements

**libreria sospesa e sovrapposta**  
wall-mounted and sit-on-top bookcase  
**basi a terra** / floorstanding base units

## finiture / finishes

**sabbia** / sabbia  
**frassino chiaro** / frassino chiaro



# 16a - 16b - 16c

## Garage

## Garage

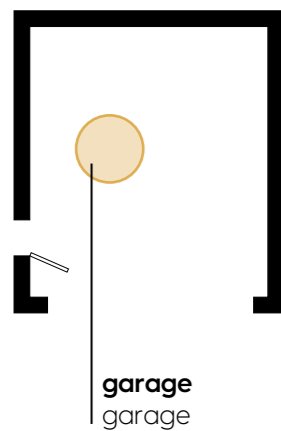

**Progettare il garage in modo ottimale, sfruttando interamente lo spazio disponibile: si può, grazie all'ampia gamma di composizioni pensate per ottimizzare gli spazi. Un ambiente dove riporre attrezzi e oggetti dedicati alla pulizia e al bucato.**

An optimal garage design that exploits every last centimetre of available space: with an extensive range of configurations designed to optimize spaces, the ultimate garage fitout is within reach. A place for storing tools and all that cleaning and laundry equipment.







**composizione garage**  
garage configuration

L / W 432,3 cm  
H / H 294,5 cm  
P / D 60,6 cm

L / W 412,3 cm  
H / H 294,5 cm  
P / D 61 cm

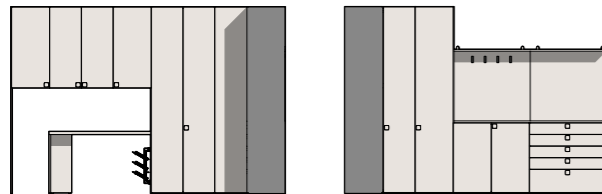

**elementi / elements**

- armadio ponte** / bridging wardrobe
- piano scrivania sp. 5 cm con fianco** / 5 cm-thick desk top with side panel
- armadio battente** / hinged door wardrobe
- basi armadio** / wardrobe base units
- boiserie Arnad** / Arnad wall panelling
- mensole sp. 3 cm** / 3 cm-thick shelves
- ganci appendiabiti** / coat hooks

**finiture / finishes**

- nuvola** / nuvola
- brunito** / bronze



16a - **16b** - 16c

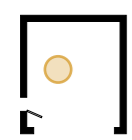

# Garage

## Garage

### composizione garage

garage configuration

L / W 360 cm      L / W 483 cm  
H / H 221,3 cm    H / H 221,3 cm  
P / D 61 cm        P / D 45,4 cm



### elementi / elements

libreria sospesa / wall-mounted bookcase  
piano sospeso con alzata sp. 5 cm / 5 cm-thick wall-mounted top with upstand  
libreria con gambe metalliche / bookcase with metal legs

### finiture / finishes

lavagna / lavagna  
bianco / bianco  
frassino chiaro / frassino chiaro





16a - 16b - **16c**

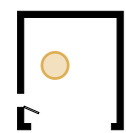

# Garage Garage



### composizione garage garage configuration

L / W 363,6 cm  
H / H 258,2 cm  
P / D 61 cm

L / W 502,5 cm  
H / H 258,2 cm  
P / D 64,2 cm

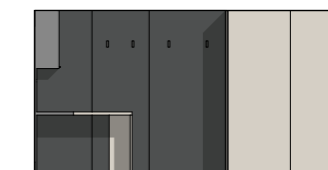

### elementi / elements

**boiserie Cover** / Cover wall panelling

**componenti Cover** / Cover components

**pensili** / wall units

**piano scrivania sp. 5 cm con fianchi** / 5 cm-thick desk top with side panels

**ganci appendiabiti** / coat hooks

**armadio scorrevole** / sliding door wardrobe

### finiture / finishes

**canapa** / canapa

**lavagna** / lavagna

**brunito** / bronze

# 17a - 17b - 17c

## Ripostiglio

### Walk-in cupboard



**Una nicchia funzionale per riporre gli oggetti del quotidiano, aiuta a mantenere la casa in ordine. Un ambiente di servizio pratico e organizzato grazie alla versatilità degli elementi che consentono di progettare infinite soluzioni d'arredo.**

A functional recess for storing everyday objects, helping keep the home tidy. A utility area turned into a practical and organized space thanks to the versatility of the various elements, which allow for the design of endless furniture solutions.







**chiusura pieghevole L 90 x H 221,3 cm**  
 folding closing system W 90 x H 221,3 cm  
**bianco / bianco**

**mensole in metallo**  
 metal shelves  
**bianco / bianco**

**composizione ripostiglio**  
 walk-in cupboard configuration

|                       |                       |
|-----------------------|-----------------------|
| <b>L / W 175,1 cm</b> | <b>L / W 145,6 cm</b> |
| <b>H / H 257,9 cm</b> | <b>H / H 257,9 cm</b> |
| <b>P / D 50,8 cm</b>  | <b>P / D 50,8 cm</b>  |



**elementi / elements**  
**cabina cremagliera**  
 slotted rail walk-in closet

**finiture / finishes**  
**cemento / cemento**  
**intonaco / intonaco**

17a - **17b** - 17c

## Ripostiglio

 Walk-in cupboard

**composizione ripostiglio**  
walk-in cupboard configuration

L / W 182 cm  
H / H 270 cm  
P / D 62,2 cm

L / W 180 cm  
H / H 257,9 cm  
P / D 46,3 cm

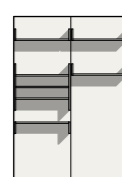
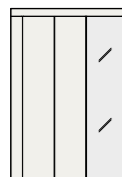

**elementi / elements**

**chiusura battente con montante compensatore**

hinged closing system with filler upright

**armadio battente / hinged door wardrobe**

**boiserie Cover / Cover wall panelling**

**componenti Cover / Cover components**

**finiture / finishes**

**olmo shade / olmo shade**

**specchio chiaro / light mirror**

**bianco / bianco**





17a - 17b - **17c**

## Ripostiglio

Walk-in cupboard



**chiusura scorrevole L 180 x H 226,7 cm**  
sliding closing system W 180 x H 226,7 cm  
**frassino chiaro, bianco** / frassino chiaro, bianco



**composizione ripostiglio**  
walk-in cupboard configuration

**L / W 172,3 cm**   **L / W 143,6 cm**  
**H / H 255,9 cm**   **H / H 255,9 cm**  
**P / D 51,8 cm**   **P / D 51,8 cm**

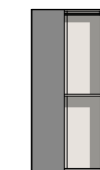
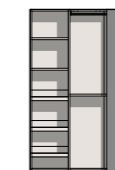

**elementi / elements**  
**cabina armadio / walk-in closet**

**finiture / finishes**

**nuvola / nuvola**

# 18a - 18b - 18c

## Disimpegno

### Vestibule

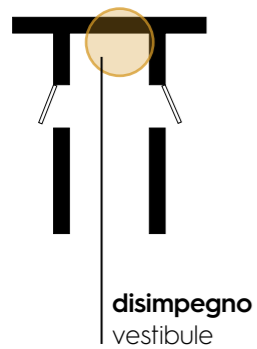

**Arredare il corridoio, trasformando uno spazio inutilizzato in modo funzionale. Grazie all'ampia scelta di elementi disponibili, il corridoio acquista carattere e diventa parte integrante del progetto d'arredo. La funzionalità incontra lo stile.**

Furnishing a corridor can transform an unused space into a functional one. The extensive choice of elements adds character to the corridor, turning it into an integral part of the interior decor project. When function meets style.

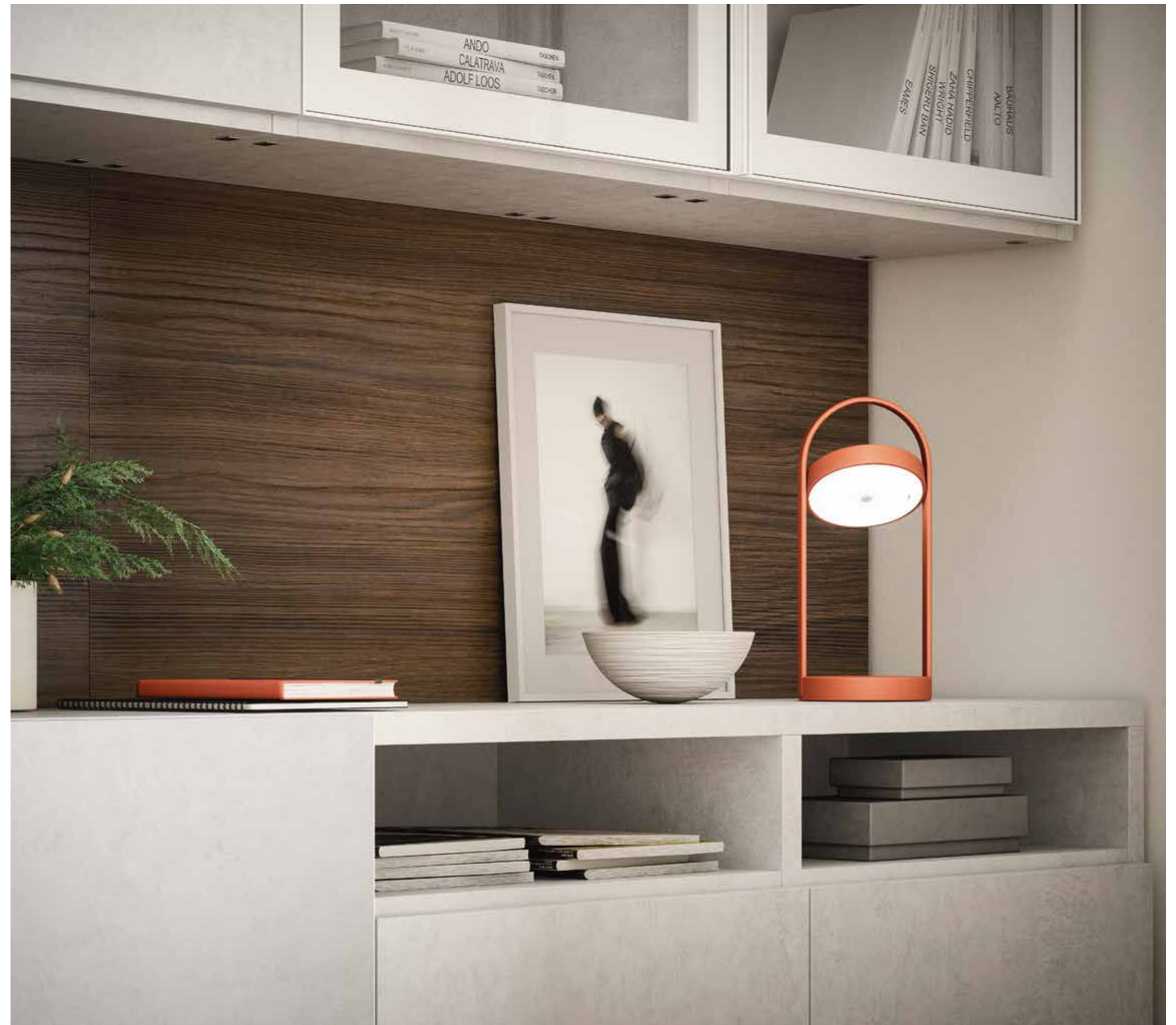





**composizione disimpegno**  
vestibule configuration

L / W 183 cm  
H / H 312,8 cm  
P / D 45,4 cm

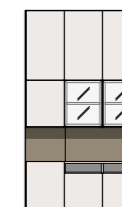

**elementi** / elements  
**libreria a terra e sospesa**  
floorstanding and wall-mounted bookcase  
**boiserie Arnad** / Arnad wall panelling

**finiture** / finishes

**calce** / calce  
**rovere cotto** / rovere cotto  
**vetro trasparente** / transparent glass  
**bianco** / bianco

18a - **18b** - 18c



# Disimpegno

## Vestibule

**composizione disimpegno**  
vestibule configuration

L / W 182,5 cm  
H / H 312,8 cm  
P / D 60,6 cm

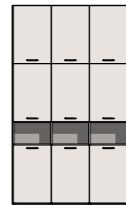

**elementi** / elements

**armadio battente** / hinged door wardrobe  
**elementi sovrapponibili** / stackable units

**finiture** / finishes

**nuvola** / nuvola

**intonaco** / intonaco

**nicel** / nicel





18a - 18b - **18c**



## Disimpegno Vestibule

**composizione disimpegno**  
vestibule configuration

L / W 182,5 cm  
H / H 312,8 cm  
P / D 60,6 cm



**elementi / elements**

**armadio battente** / hinged door wardrobe  
**chiusura battente** / hinged closing system  
**elementi sovrapponibili** / stackable units  
**libreria a terra** / floorstanding bookcase

**finiture / finishes**

**bianco** / bianco  
**specchio chiaro** / light mirror



**sezione tecnica**  
technical section



# Il sistema cinquanta3

## The cinquanta3 system



**finiture e colori** / finishes and colours pag. 264

**tessuti** / fabrics pag. 266

**maniglie** / handles pag. 270

**il sistema** / the system

 **contenitori** / storage units pag. 280

 **librerie** / bookcases pag. 284

 **sistema Uniko** / Uniko system pag. 288

 **boiserie** / wall panelling pag. 290

 **armadi** / wardrobes pag. 294

 **cabine** / walk-in closets pag. 302

**letti** / beds pag. 306

**gruppi letto** / bedroom units pag. 324

**scrivanie** / desks pag. 328

**tavoli** / tables pag. 336

**sedute** / seating pag. 342



**singoli elementi del sistema**  
individual parts of the system

**composizione finita**  
finished configuration

# Finiture e colori

## Finishes and colours

### Finiture colore

Colour finishes

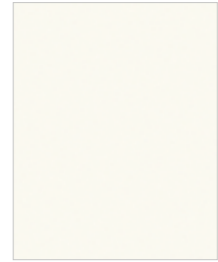

**01 bianco**  
basic

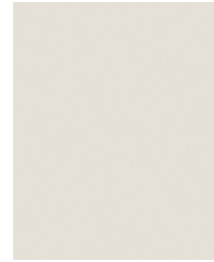

**50 nuvola**  
basic



**3C canapa**  
basic



**20 cashmere**  
smart



**55 sabbia**  
smart



**52 basalto**  
smart



**25 cemento**  
smart



**16 lavagna**  
smart

### Finiture ecolegno

Eco-wood finishes



**28 olmo shade**  
basic



**79 frassino chiaro**  
smart



**80 rovere cotto**  
smart



**54 noce naturale**  
smart

### Finiture materiche

Textured finishes



**57 calce**  
smart



**77 intonaco**  
smart

### Vetro standard

Standard glass



**VE vetro trasparente**  
VE transparent glass



**VF vetro fumé**  
VF smoked glass

### Vetro laccato

Lacquered glass



**VB vetro bianco**  
VB white glass

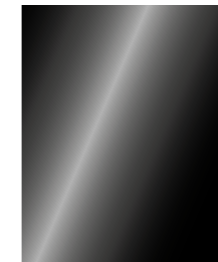

**VN vetro nero**  
VN black glass

### Vetro acidato

Etched glass



**VA vetro acidato**  
VA etched glass

### Specchio

Mirror



**SP specchio chiaro**  
SP light mirror



**SR specchio brunito**  
SR tinted mirror

### Finiture metalliche

Metal finishes



**6Z nichel**



**5Z titanio**



**3G grafite**

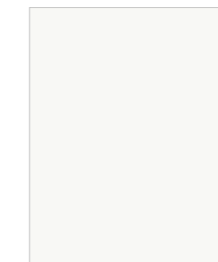

**01 bianco**



**16 lavagna**



# Tessuti Fabrics

## Tessuto Soft Soft fabric



T563

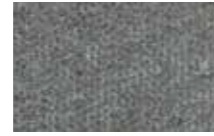

T564



T565



T560



T561

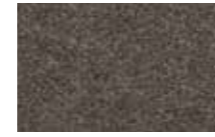

T562



T566



T567



T568

## Tessuto Spot Spot fabric



T540



T541



T542

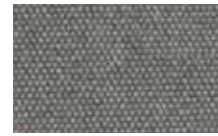

T543

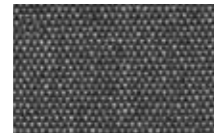

T544



T545



T546



T547



T548



T549



T551

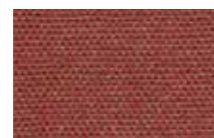

T550



T552



T553

## Tessuto Thick Thick fabric



T527



T526



T524



T525



T530



T529



T523



T521



T528



T522

## Tessuto Cross Cross fabric



T515



T513

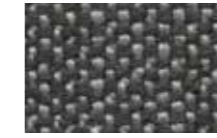

T512



T500



T502



T504



T505



T506



T508

# Tessuti Fabrics

## Ecopelle Smooth Smooth imitation leather



T150

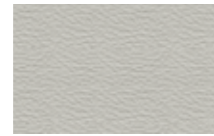

T164



T175

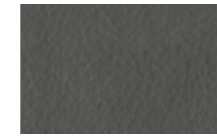

T167



T171



T151



T170



T172



T152



T169



T173



T157

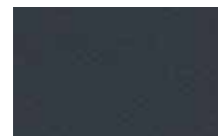

T174

# Tessuti speciali Special fabrics

## Feltro Felt

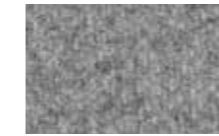

TF21



TF22



TF23



TF24



TF25



TF26

## Rivestimento per sedie su ruote Covers for swivel chairs



TL30



TL31



TL32



TL33



TL34



TL35



TL36

## Fettuccia per bordo a contrasto Contrasting piping



CC10



CC11



CC12



CC13



CC14



CC15



# Maniglie

## Handles



**A53 / A53L**  
7 x 7 x 2,5 cm



**A54 / A54L**  
7 x 7 x 2,5 cm



**A51**  
5,8 x 5,8 x 3 cm



**A28**  
5 x 1,8 x 0,3 cm



**A29 / A29L**  
11 x 4,5 x 0,2 cm



**A52**  
7,4 x 7,4 x 4 cm



**A40**  
20 x 1,8 x 0,6 cm



**A47**  
44,6/59,6/74,6/89,6/119,6 x 1,8 x 0,6 cm

# Maniglie

## Handles



**A68 / A68L**  
12 x 0,8 x 2 cm



**A69 / A69L**  
28,5 x 0,8 x 2 cm



**A70 / A70L**  
59,5 x 0,8 x 2 cm

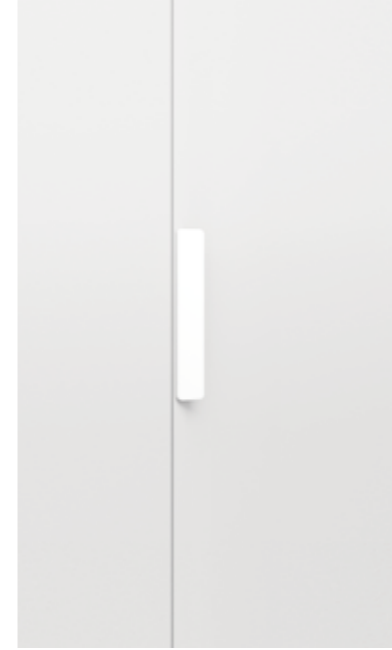

**A37 / A37L**  
17 x 2,6 x 1,7 cm



**A60 / A60L**  
18 x 3,4 x 1,9 cm



**A72 / A72L**  
12,5 x 3,1 x 2,8 cm



**A74 / A74L**  
28,6 x 3,1 x 2,8 cm



**A75 / A75L**  
60 x 3,1 x 2,8 cm



# Maniglie

## Handles



**A57**  
16,9 x 1,1 x 3,2 cm



**A63**  
32,9 x 1,1 x 3,2 cm



**A58**  
23,5 x 1,2 x 3,2 cm



**A66**  
55,5 x 1,2 x 3,2 cm



**A59**  
18,2 x 1,5 x 2,6 cm



**A67**  
50,2 x 1,5 x 2,6 cm



**A73**  
84,6 x 1,1 x 3 cm

# Maniglie

## Handles



**A76 / A76L**  
110 x 3,1 x 2,8 cm



**A38 / A38L**  
128 x 2,6 x 1,7 cm



**A91 / A91L**  
219,2/237,5/255,8 x 3,1 x 2,8 cm



**A78 / A78L**  
110 x 0,8 x 2 cm



**A93**  
219,2/237,5/255,8 x 3,8 cm



**A95**  
H frontale / front x 4 x 2,2 cm



**A77 / A77L**  
110 x 3,4 x 1,9 cm



**A92 / A92L**  
219,2/237,5/255,8 x 3,4 x 1,9 cm



# Serrature

## Locks



**Serratura cilindrica**  
Cylindrical lock

**Serratura cilindrica con cifratura differenziata**  
Cylindrical lock keyed to differ

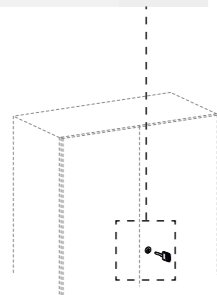

**Serratura cilindrica**  
Cylindrical lock

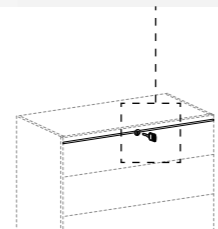

**Serratura ad asta differenziata**  
Espagnolette lock keyed to differ

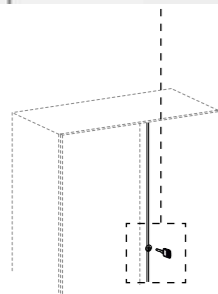

**Serratura cifrata**  
Combination lock

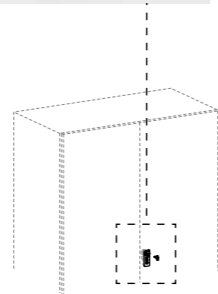

# Push-pull e Appendiabiti

## Push-to-Open systems and Coat Hooks



**Push-pull ante**  
Push-to-open for doors



**Push-pull cassetti**  
Push-to-open for drawers



**Gancio appendiabiti**  
Coat hook



**Pomolo appendiabiti**  
Clothes hanger knob

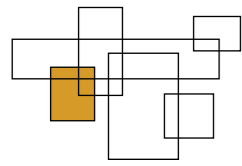

# Contenitori

## Storage units

**Flessibilità e componibilità degli elementi contraddistinguono i contenitori. L'ampia modularità e la vasta gamma di finiture disponibili permette di progettare in piena libertà secondo lo stile del proprio spazio abitativo.**

The elements' flexibility and modular design are distinguishing traits of the base storage units and wall units. With plenty of module options and an extensive range of finishes to choose from, you can design a solution just the way you want to match your interior scheme.

### basi a terra

floorstanding base units

**altezze / heights**  
20 - 38,3 - 56,6 - 74,9 - 111,5

**larghezze / widths**  
45 - 60 - 75 - 90 - 120

**profondità / depths**  
35,4 - 45,4 - 60,6

### basi in appoggio e sospese

sit-on-top and wall-mounted base units

**altezze / heights**  
19,3 - 37,6 - 55,9 - 74,2 - 110,8

**larghezze / widths**  
45 - 60 - 75 - 90 - 120

**profondità / depths**  
35,4 - 45,4 - 60,6

### pensili

wall units

**altezze / heights**  
36,6 - 54,9 - 73,2 - 91,5

**larghezze / widths**  
30 - 45 - 60 - 75 - 90 - 120

**profondità / depths**  
35,4

### casellari

shelving units

**altezze / heights**  
36,6 - 54,9 - 73,2

**larghezze / widths**  
30 - 45 - 60 - 75 - 90

**profondità / depths**  
25 - 33

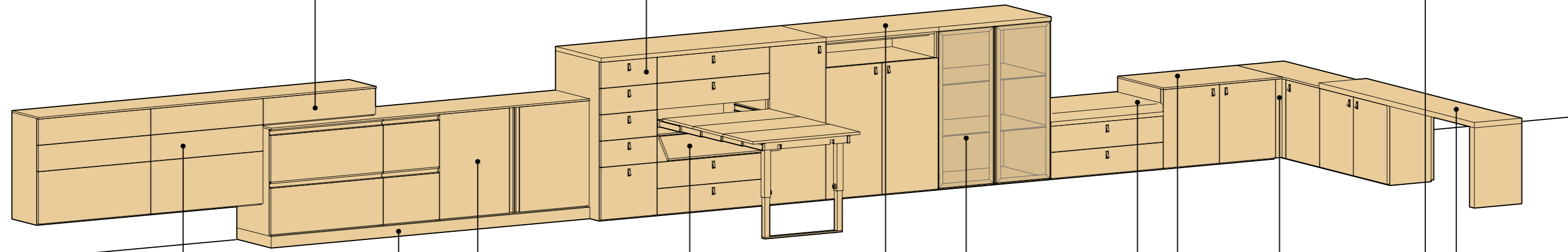
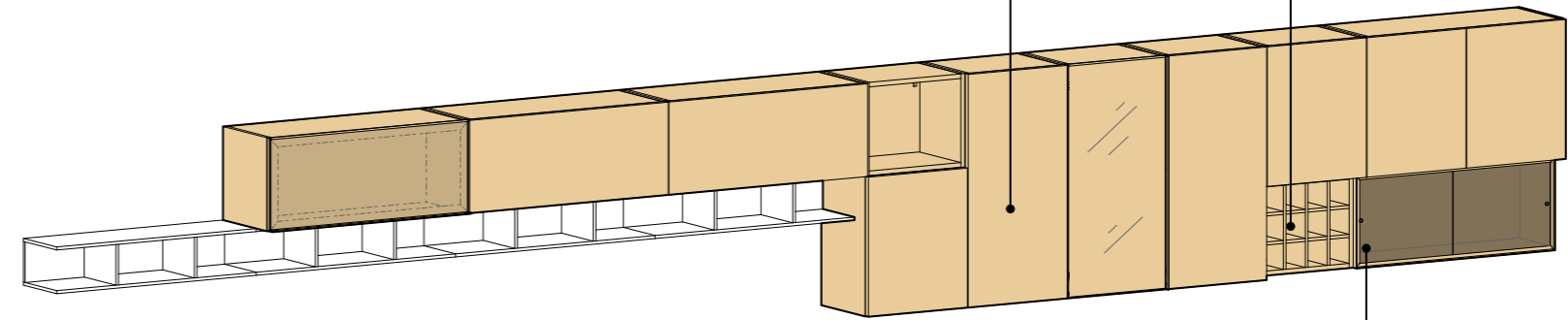

**pedana al ml**  
plinth per m  
H 3,7 - 5,7 - 8,7

**base con accessori estraibili**  
base unit with pull-out accessories

**top sp. 3 cm**  
3 cm-thick top

**seduta imbottita sopratop**  
padded seat for top

**top sp. 1,2 cm**  
1,2 cm-thick top

**base ad angolo**  
corner base unit

**piano in appoggio**  
sit-on-top top

### Tipologia ante

Door type

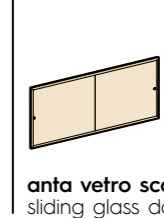
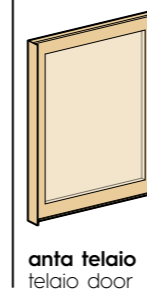
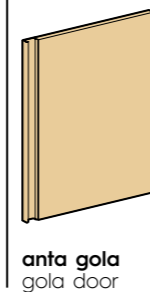
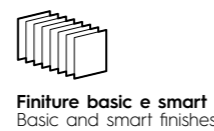
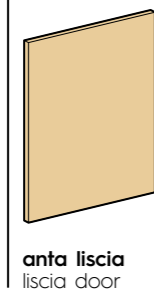



# Contenitori

## Storage units

### basi a terra / floorstanding base units

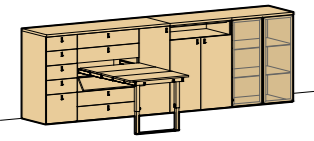

04c - pag. 56



05d - pag. 88



10a - pag. 169



13b - pag. 214

altre composizione alle pagine / other configurations on pages  
31, 37, 38, 52, 70, 98, 105, 114, 124, 156, 234

### basi in appoggio e sospese / sit-on-top and wall-mounted base units

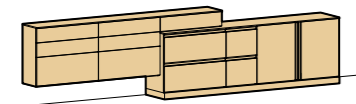

04e - pag. 65



05b - pag. 79



05b - pag. 81



07a - pag. 122

altre composizione alle pagine / other configurations on pages  
22, 28, 37, 51, 74, 84, 87, 97, 102, 107, 116, 134, 141, 155, 175, 180, 188, 205

### pensili e casellari / wall units and shelving units

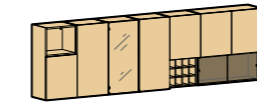

04c - pag. 52



05d - pag. 91



06c - pag. 107



09c - pag. 165

altre composizione alle pagine / other configurations on pages  
28, 51, 65, 74, 79, 97, 102, 105, 114, 122, 164, 188, 212, 233, 243

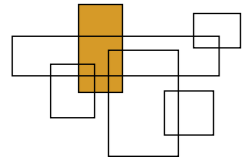

# Librerie Bookcases

Gli elementi libreria offrono un'ampia gamma di soluzioni, disponibili in differenti finiture e colori. Diverse tipologie di anta definiscono lo stile della composizione, caratterizzando l'ambiente in modo funzionale e personalizzato.

Bookcase units offer an extensive range of solutions, available in various finishes and colours. Different door types determine the style of the configuration, giving the room a distinctive functional and customized look.

## librerie ponte bridging bookcases

altezze / heights  
221,3 - 239,6 - 257,9 - 294,5

larghezze / widths  
150 - 180 - 210

profondità / depths  
35,4 - 45,4

## librerie sovrapposte sit-on-top bookcases

altezze per top 1,2 cm / heights for 1.2 cm top  
126,9 - 145,2 - 163,5 - 181,8 - 200,1 - 218,4 - 236,7  
255 - 273,3

altezze per top 3 cm / heights for 3 cm top  
125,1 - 143,4 - 161,7 - 180 - 198,3 - 216,6 - 234,9  
253,2 - 271,5

larghezze / widths  
30 - 45 - 60 - 90 - 120

profondità / depths  
35,4

## librerie a terra floorstanding bookcases

altezze / heights  
38,3 - 56,6 - 74,9 - 111,5 - 148,1 - 203  
221,3 - 239,6 - 257,9 - 294,5

larghezze / widths  
30 - 45 - 60 - 90 - 120

profondità / depths  
35,4 - 45,4

## librerie sospese wall-mounted bookcases

altezze con cappello / heights with top cover  
138,1 - 56,4 - 74,7 - 111,3 - 147,9 - 184,5

altezze con top intero / heights with one-piece top  
37,6 - 55,9 - 74,2 - 110,8

larghezze / widths  
30 - 45 - 60 - 90 - 120

profondità / depths  
35,4

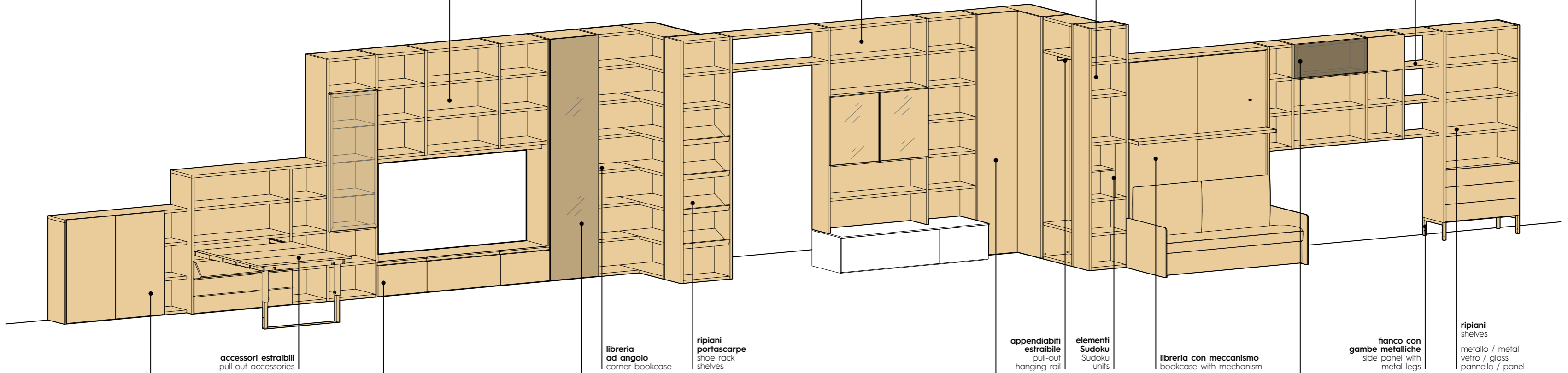

accessori estraibili  
pull-out accessories

libreria  
ad angolo  
corner bookcase

ripiani  
portascarpe  
shoe rack  
shelves

appendiabiti  
estraibile  
pull-out  
hanging rail

elementi  
Sudoku  
Sudoku  
units

libreria con meccanismo  
bookcase with mechanism

fianco con  
gambe metalliche  
side panel with  
metal legs

ripiani  
shelves  
metallo / metal  
vetro / glass  
pannello / panel

## Tipologia ante Door type

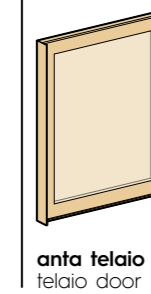
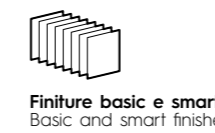
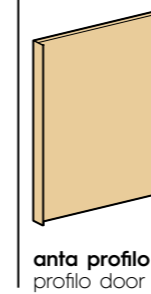
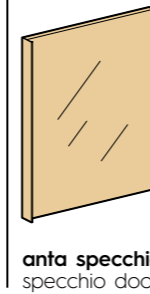
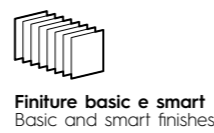
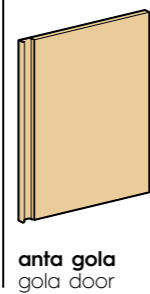
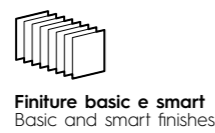
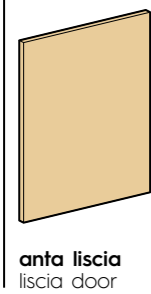



**librerie a terra** / floorstanding bookcases

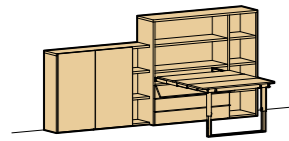

**03a** - pag. 35



**06c** - pag. 111



**07b** - pag. 127



**16b** - pag. 240

**altre composizioni alle pagine** / other configurations on pages  
59, 67, 73, 82, 88, 93, 104, 108, 121, 143, 164, 172, 187, 200, 203, 211, 217, 255, 258

**librerie sospese** / wall-mounted bookcases

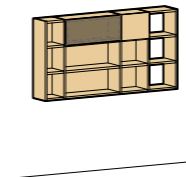

**04a** - pag. 47



**10c** - pag. 172



**12c** - pag. 200



**18a** - pag. 255

**altre composizioni alle pagine** / other configurations on pages  
35, 38, 59, 88, 93, 225, 233, 234, 240

**librerie sovrapposte** / sit-on-top bookcases

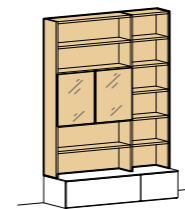

**03c** - pag. 38



**05d** - pag. 88



**15c** - pag. 234

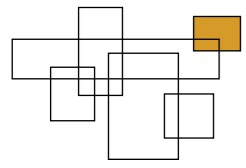

# Sistema Uniko

## Uniko system

Un sistema caratterizzato da montanti che sostengono gli elementi della composizione. Una soluzione pratica e flessibile che arreda mantenendo gli spazi ariosi. Gli elementi sono disponibili in un'ampia gamma di finiture e colori.

A system featuring uprights that support the configuration's various elements. A practical and flexible solution that furnishes spaces while keeping them light and airy. The elements come in a wide range of finishes and colours.

# Sistema Uniko

## Uniko system

sistema Uniko / Uniko system

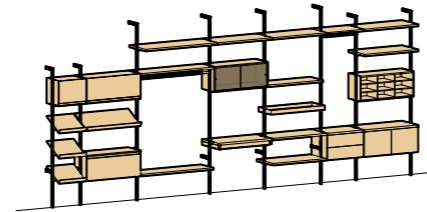

01b - pag. 21



04c - pag. 54



06a - pag. 97



10a - pag. 168



13b - pag. 212

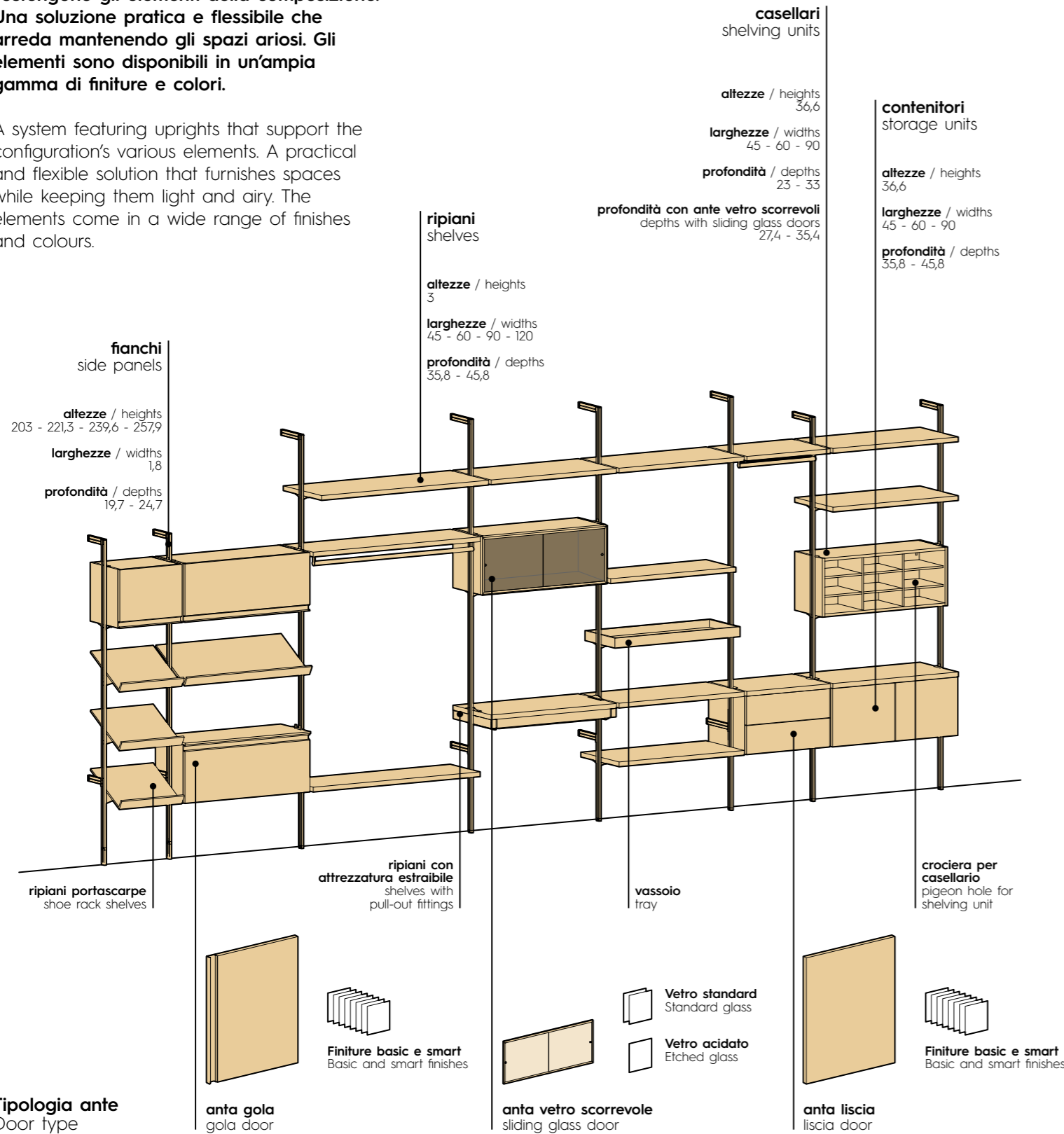



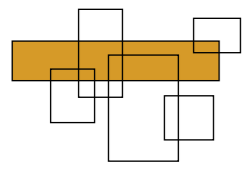

# Boiserie

## Wall panelling

Un elemento che arreda e completa la composizione, attrezzabile con mensole, pensili, basi a terra o sospese. Le diverse finiture e i colori disponibili permettono ampia possibilità di personalizzazione.

An element that adds a decorative finishing touch to the configuration, accommodating shelves, wall units, and floorstanding or wall-mounted base units. The various finish and colour options provide plenty of scope for customizing.

### boiserie Arnad

Arnad wall panelling

**pannelli / panels**  
**altezze / heights**  
 36,3 - 75,2 - 91,5 - 109,8  
**larghezze / widths**  
 60 - 90 - 120  
**profondità / depths**  
 2,9

### boiserie Cover

Cover wall panelling

**pannelli / panels**  
**altezze / heights**  
 111,5 - 129,8 - 148,1 - 202,3  
 221,3 - 239,6 - 257,9 - 294,5  
**larghezze / widths**  
 45 - 60 - 90 - 120  
**profondità / depths**  
 3,3

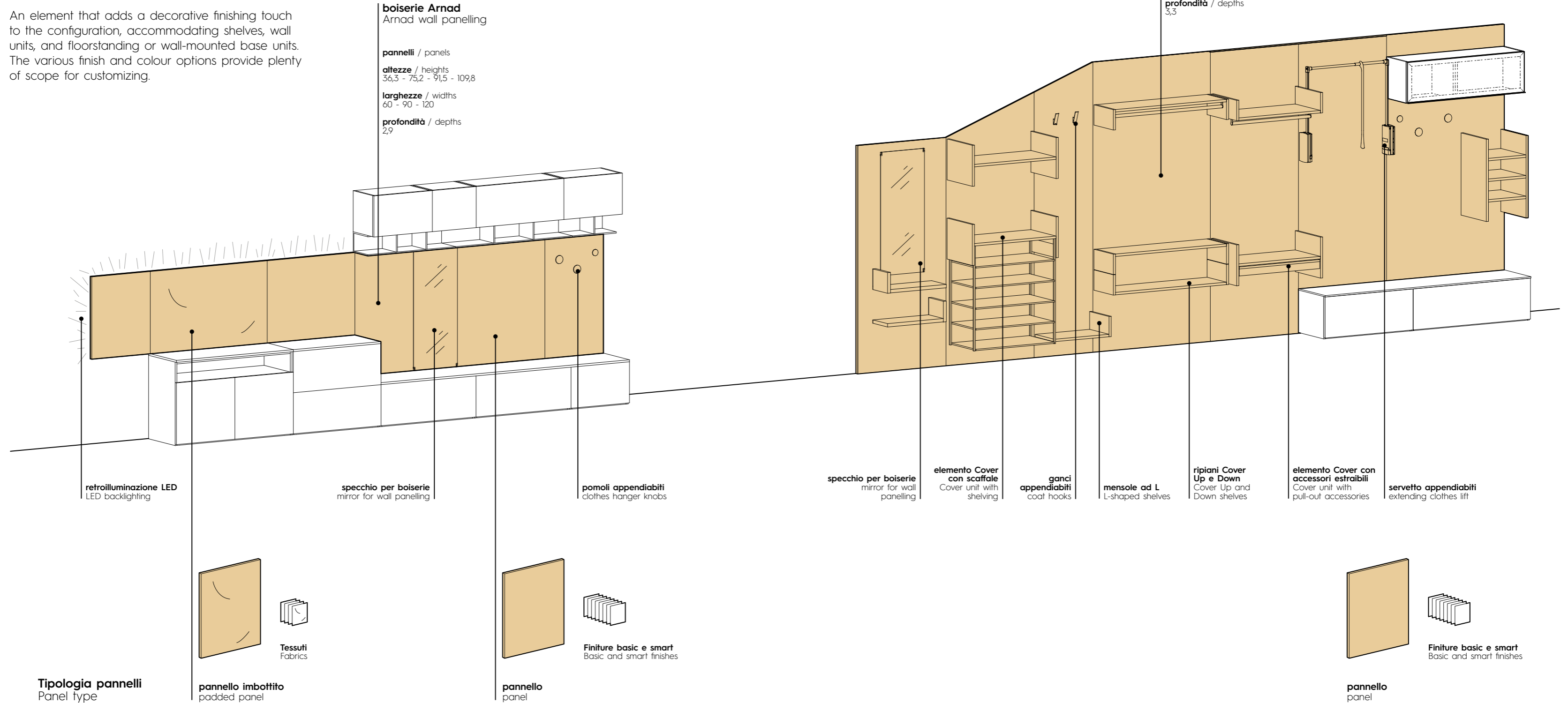

**Tipologia pannelli**  
Panel type

**pannello imbottito**  
padded panel

**pannello**  
panel

**pannello**  
panel

# Boiserie

Wall panelling

## boiserie Arnad / Arnad wall panelling

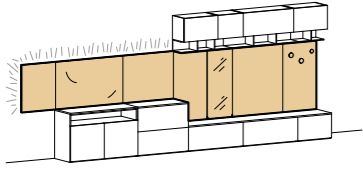

01c - pag. 22



05a - pag. 74



08a - pag. 133



11c - pag. 187

altre composizione alle pagine / other configurations on pages  
19, 21, 35, 38, 45, 56, 82, 102, 124, 125, 138, 141, 145, 185, 205, 211, 238, 255

## boiserie Cover / Cover wall panelling

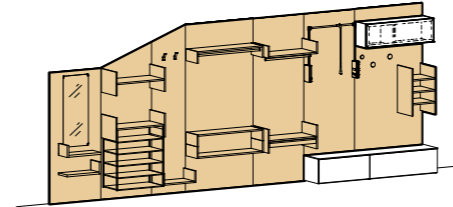

03b - pag. 37



04b - pag. 51



10b - pag. 171



16c - pag. 243

altre composizione alle pagine / other configurations on pages  
28, 31, 114, 155, 195, 211, 248



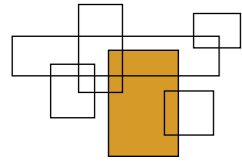

# Armadi Wardrobes

Progettati per il contenimento, permettono di organizzare lo spazio grazie alla grande modularità degli elementi disponibili. Perfetti per ottimizzare lo spazio e renderlo unico, scegliendo tra la vasta gamma di colori e finiture quelli più adatti.

Designed for storage needs, the units come with a huge range of module options, making them perfect for organizing a space. Perfect for optimizing the space and making it unique, choosing the most appropriate colours and finishes from the extensive range.

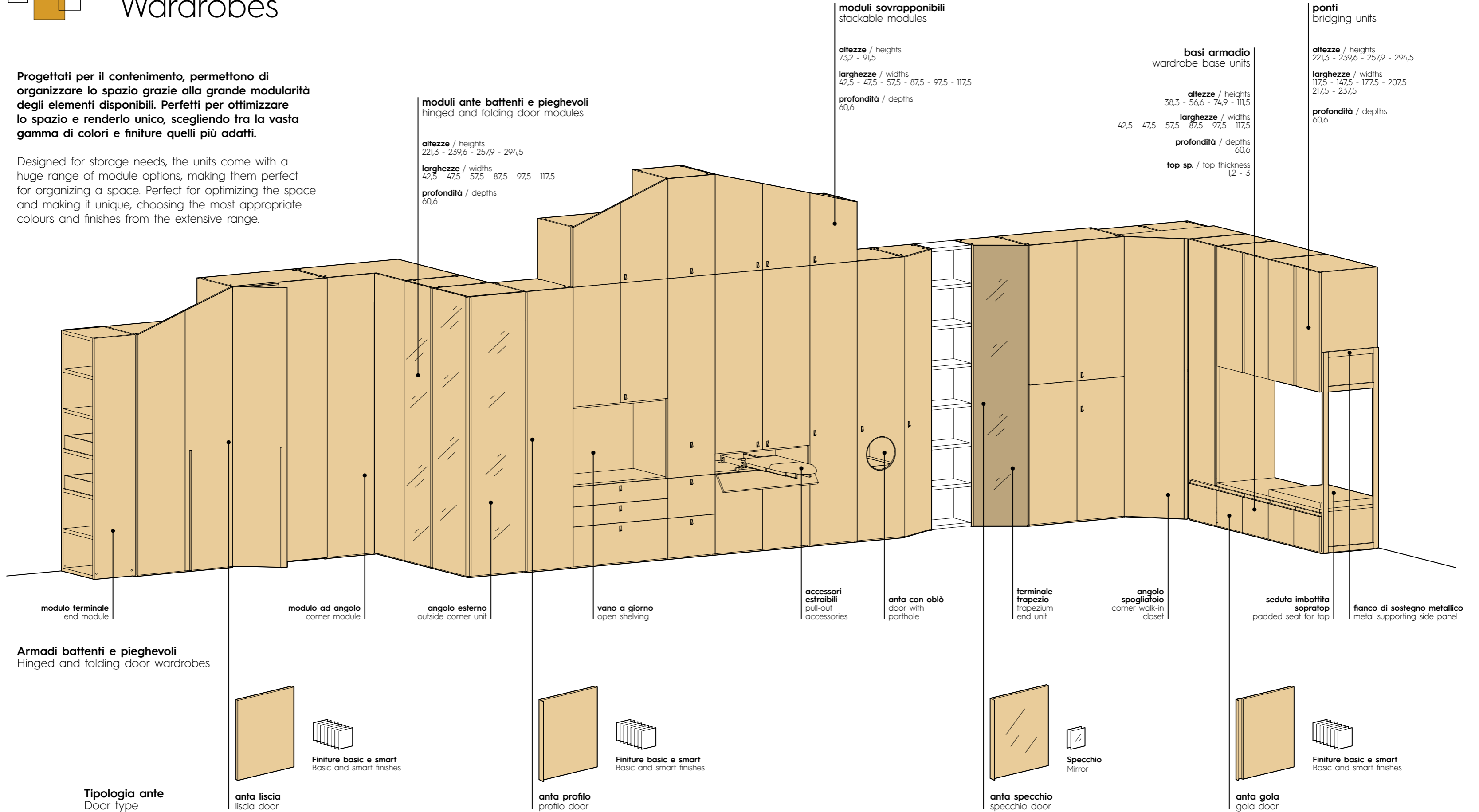

**moduli sovrapponibili**  
stackable modules

**altezze / heights**  
73,2 - 91,5

**larghezze / widths**  
42,5 - 47,5 - 57,5 - 87,5 - 97,5 - 117,5

**profondità / depths**  
60,6

**moduli ante battenti e pieghevoli**  
hinged and folding door modules

**altezze / heights**  
221,3 - 239,6 - 257,9 - 294,5

**larghezze / widths**  
42,5 - 47,5 - 57,5 - 87,5 - 97,5 - 117,5

**profondità / depths**  
60,6

**basi armadio**  
wardrobe base units

**altezze / heights**  
38,3 - 56,6 - 74,9 - 111,5

**larghezze / widths**  
42,5 - 47,5 - 57,5 - 87,5 - 97,5 - 117,5

**profondità / depths**  
60,6

**top sp. / top thickness**  
1,2 - 3

**ponti**  
bridging units

**altezze / heights**  
221,3 - 239,6 - 257,9 - 294,5

**larghezze / widths**  
117,5 - 147,5 - 177,5 - 207,5 - 217,5 - 237,5

**profondità / depths**  
60,6

**modulo terminale**  
end module

**modulo ad angolo**  
corner module

**angolo esterno**  
outside corner unit

**vano a giorno**  
open shelving

**accessori estraibili**  
pull-out accessories

**anta con oblò**  
door with porthole

**terminale trapezio**  
trapezium end unit

**angolo spogliatoio**  
corner walk-in closet

**seduta imbottita sopratop**  
padded seat for top

**fianco di sostegno metallico**  
metal supporting side panel

**Armadi battenti e pieghevoli**  
Hinged and folding door wardrobes

**Tipologia ante**  
Door type

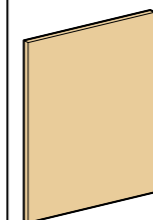

**anta liscia**  
liscia door



**Finiture basic e smart**  
Basic and smart finishes

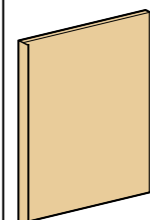

**anta profilo**  
profilo door



**Finiture basic e smart**  
Basic and smart finishes

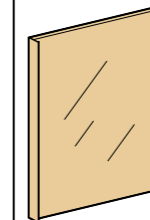

**anta specchio**  
specchio door



**Specchio**  
Mirror

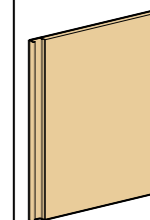

**anta gola**  
gola door



**Finiture basic e smart**  
Basic and smart finishes

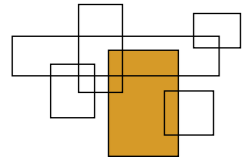

# Armadi Wardrobes

## Service Service

**altezze / heights**  
221,3 - 239,6 - 257,9 - 294,5

**larghezze / widths**  
72,5 - 87,5 - 97,5 - 117,5

**profondità / depths**  
72,4

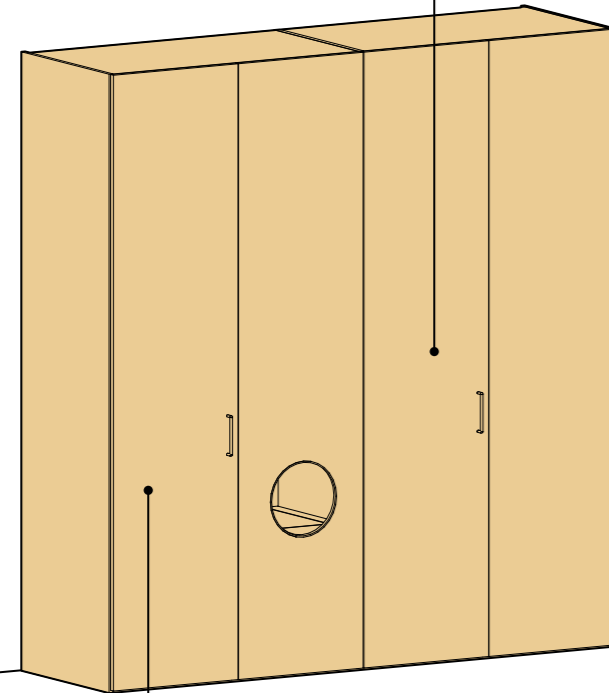

**Armadi Service**  
Service cupboards



**anta liscia**  
liscia door

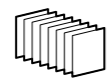

**Finiture basic e smart**  
Basic and smart finishes

**Tipologia ante**  
Door type

## Light Light

**altezze / heights**  
221,3 - 257,9

**larghezze / widths**  
42,9 - 87,6

**profondità / depths**  
60,6

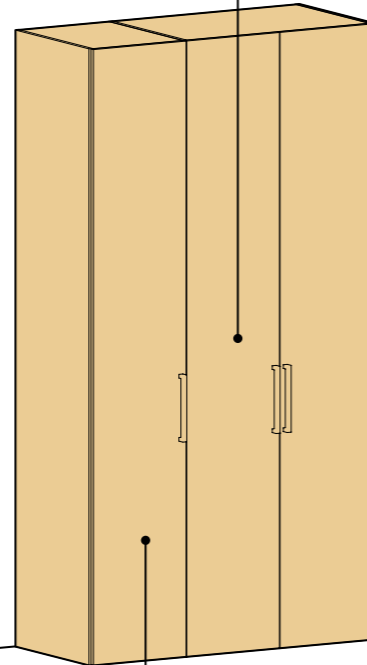

**Armadi Light**  
Light wardrobes

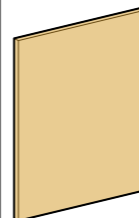

**anta liscia**  
liscia door



**Finiture**  
Finishes  
Bianco, Nuvola

## moduli ante scorrevoli sliding door modules

**altezze / heights**  
221,3 - 239,6 - 257,9

**larghezze / widths**  
72,5 - 87,5 - 97,5

**profondità / depths**  
64,2 - 66,3 - 67,5

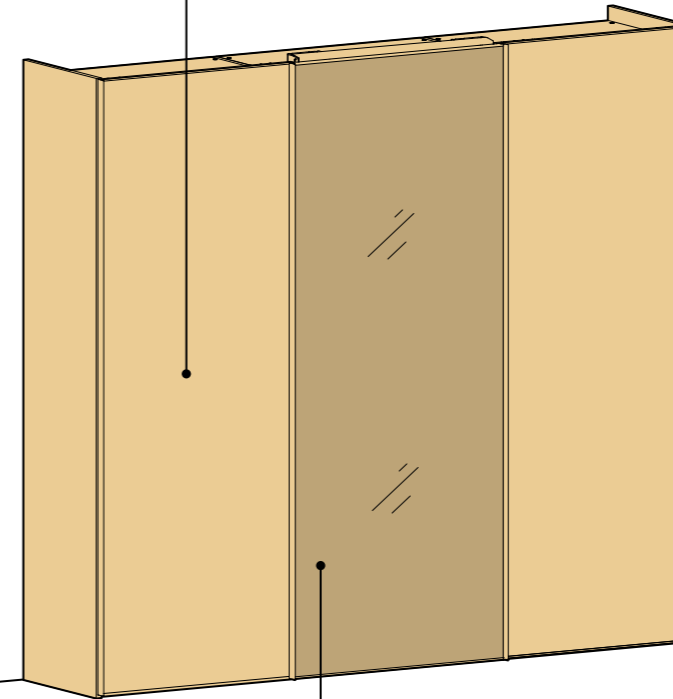

**Armadi scorrevoli**  
Sliding door wardrobes

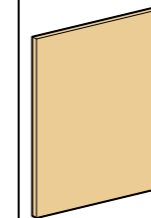

**anta liscia**  
liscia door

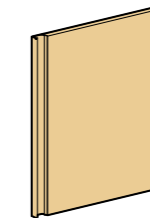

**anta gola**  
gola door

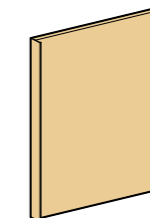

**anta profilo**  
profilo door

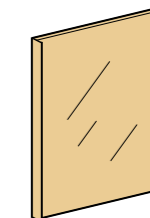

**anta specchio**  
specchio door

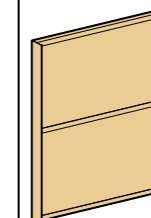

**anta cornice**  
cornice door

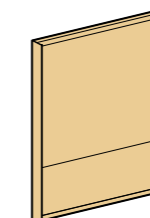

**anta telaio A**  
telaio A door

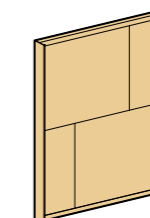

**anta telaio B**  
telaio B door



**Finiture basic e smart**  
Basic and smart finishes



**Finiture specchio**  
Mirror finishes



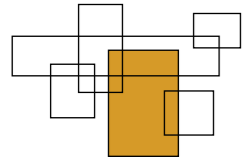

# Armadi Wardrobes

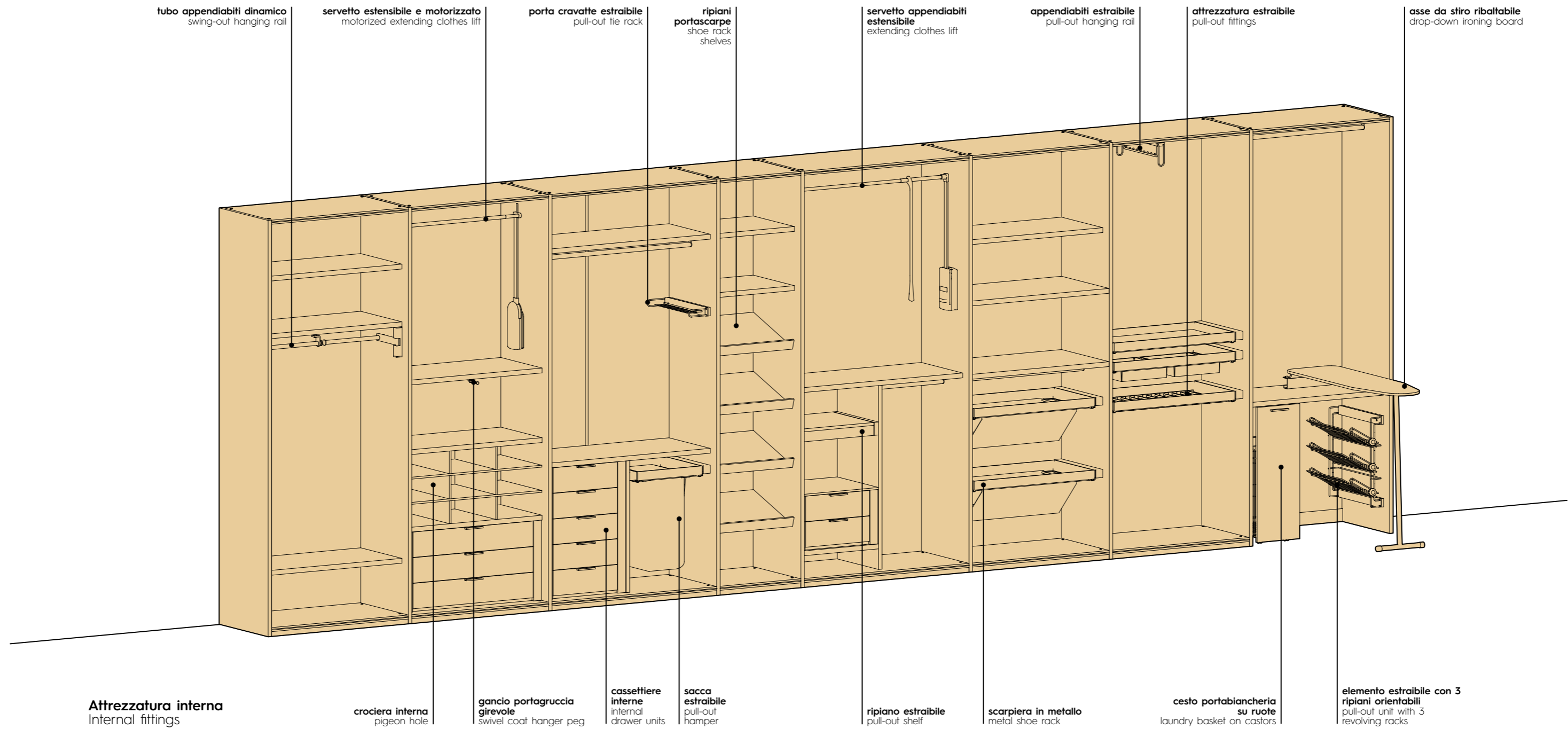

anta battente e pieghevole / hinged and folding door

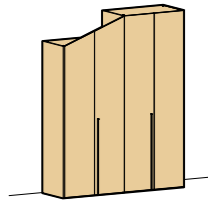

02a - pag. 27



05c - pag. 82



08b - pag. 138



11b - pag. 185

altre composizione alle pagine / other configurations on pages  
19, 79, 125, 133, 145, 155, 162, 172, 179, 195, 197, 225, 238, 248, 256, 258

basi armadio / wardrobe base units



08a - pag. 133



13a - pag. 211

altre composizione alle pagine / other configurations on pages  
19, 45, 82, 125, 138, 184, 195, 238

Service / Service

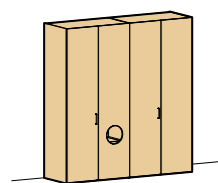

14b - pag. 222

ponti / bridging units

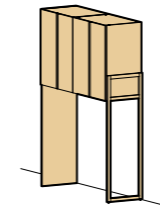

04a - pag. 45



08d - pag. 145



09a - pag. 155



16a - pag. 238

altre composizione alle pagine / other configurations on pages  
82, 162, 171, 185, 197

anta scorrevole / sliding door

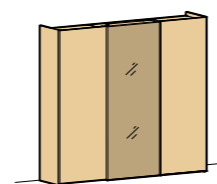

08c - pag. 143



08e - pag. 148



11c - pag. 187



16c - pag. 243



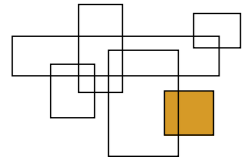

# Cabine

## Walk-in closets

Le cabine si caratterizzano per l'ampia flessibilità compositiva. Sono adattabili alle diverse tipologie di stanza, anche mansardata. Per maggior pulizia e ordine, è possibile completare lo spazio cabina con chiusure battenti, pieghevoli o scorrevoli.

Walk-in closets stand out for their impressive modular flexibility. They can be tailored to suit rooms of various kinds, even attic spaces. For a cleaner and tidier look, the walk-in closet space can be finished off with hinged, folding or sliding closing systems.

### cabina armadio walk-in closet

**altezze / heights**  
219,3 - 237,6 - 255,9 - 292,5

**larghezze / widths**  
42,5 - 47,5 - 57,5 - 87,5 - 97,5 - 117,5

**profondità / depths**  
51,8

**attrezzatura interna vedi pag. 298**  
internal fittings page 298

### cabina a spalla walk-in closet system with load-bearing side panels

**altezze / heights**  
221,3 - 239,6 - 257,9 - 294,5

**larghezze / widths**  
48 - 63 - 93 - 123

**profondità / depths**  
43 - 44,5

### cabina cremagliera slotted rail walk-in closet

**altezze / heights**  
221,3 - 239,6 - 257,9

**larghezze / widths**  
45 - 60 - 90 - 120

**profondità / depths**  
40,8 - 50,8

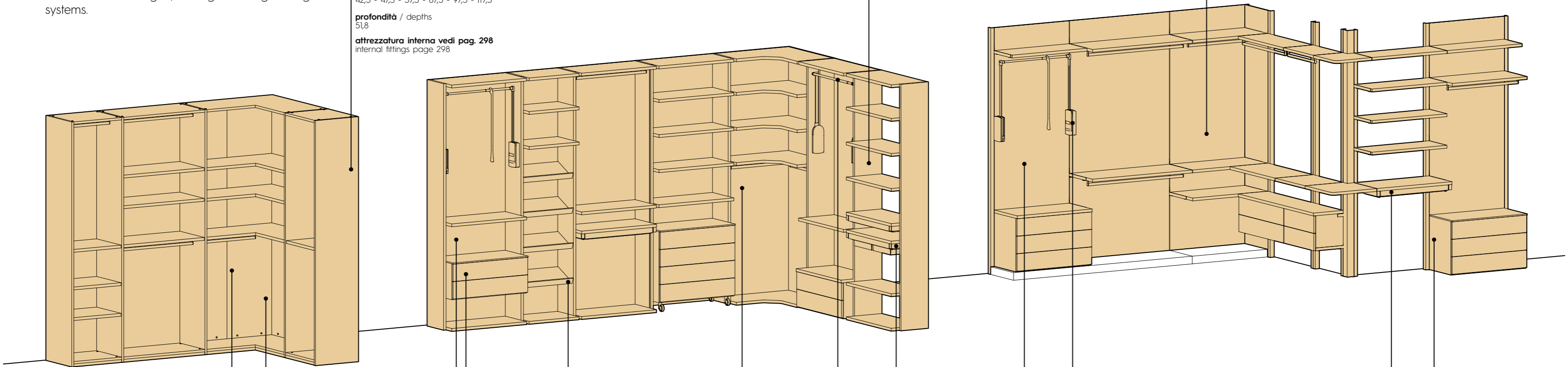

**Attrezzatura interna**  
Internal fittings

**modulo ad angolo**  
corner module

**cassettiere**  
drawer units

a terra / floorstanding  
sospese / wall-mounted  
su ruote / on castors

**ripiani  
portascarpe**  
shoe rack  
shelves

**colonna ad angolo**  
corner column

**servetto  
estensibile e  
motorizzato**  
motorized  
extending  
clothes lift

**attrezzatura estraibile**  
pull-out fittings

**servetto estensibile**  
extending clothes lift

**attrezzatura estraibile**  
pull-out fittings

**cassettiere** drawer units

a terra / floorstanding  
sospese / wall-mounted  
in appoggio / sit-on-top



**Finiture**  
Finishes  
Nuvola



**Finiture basic e smart**  
Basic and smart finishes



**Finiture basic e smart**  
Basic and smart finishes

# Cabine

Walk-in closets

## **cabina armadio** / walk-in closet

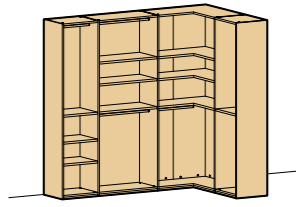

12d - pag. 206



15a - pag. 231



17c - pag. 251

## **cabina a spalla** / walk-in closet system with load-bearing side panels

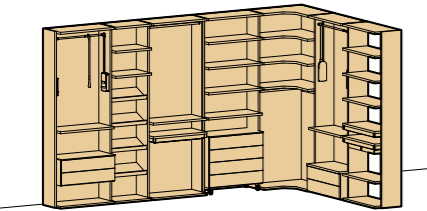

11a - pag. 179



15b - pag. 233

## **cabina cremagliera** / slotted rail walk-in closet

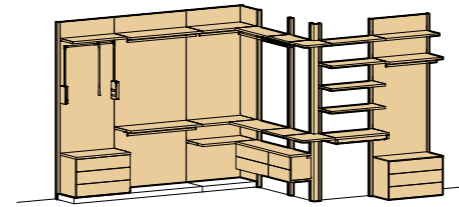

08e - pag. 148



09b - pag. 159



14a - pag. 221



17a - pag. 247



# Letti componibili

## Modular beds

**Letti in nobilitato**  
Beds in foil-wrapped finish

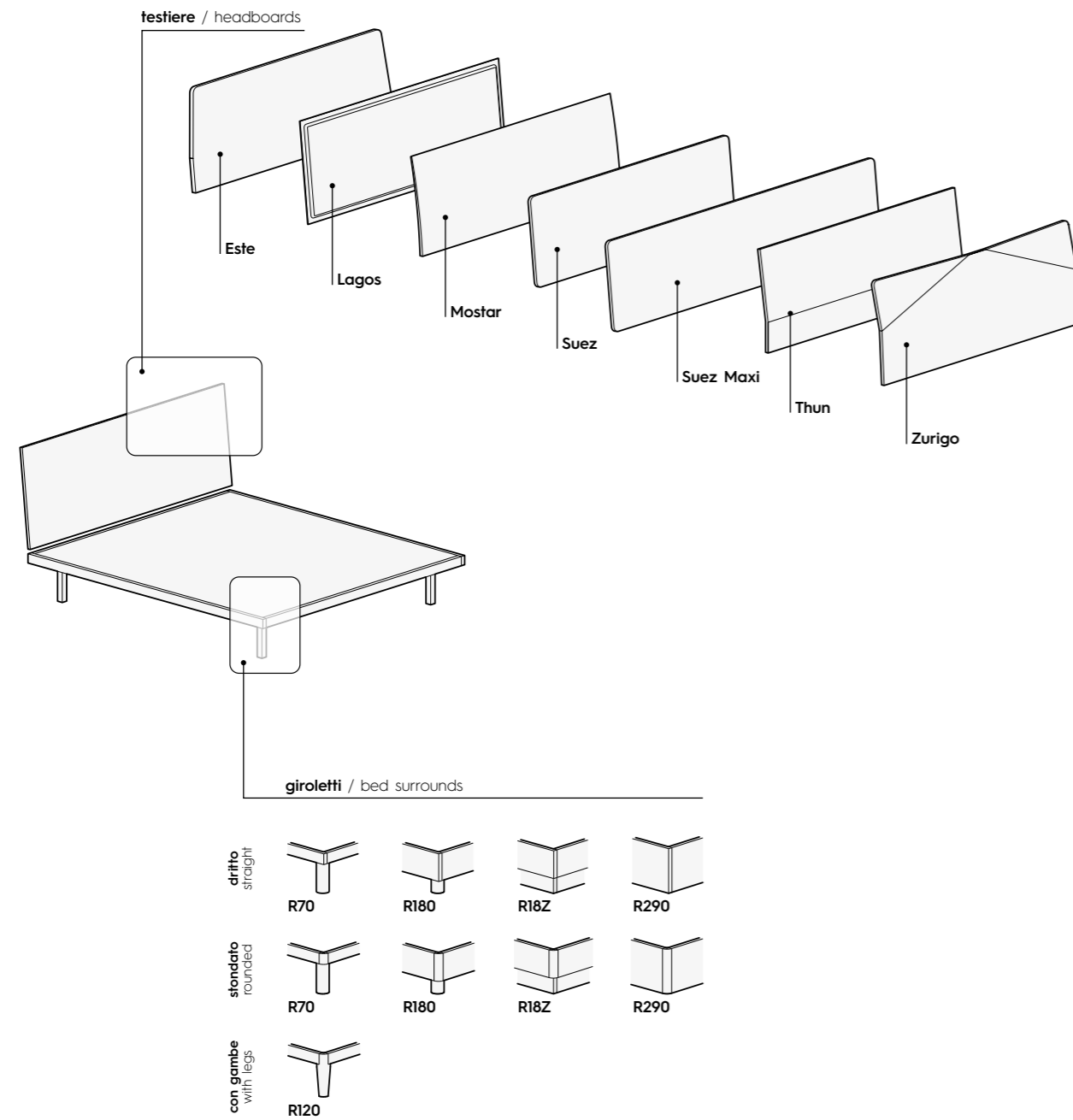

**Letti imbottiti**  
Padded beds

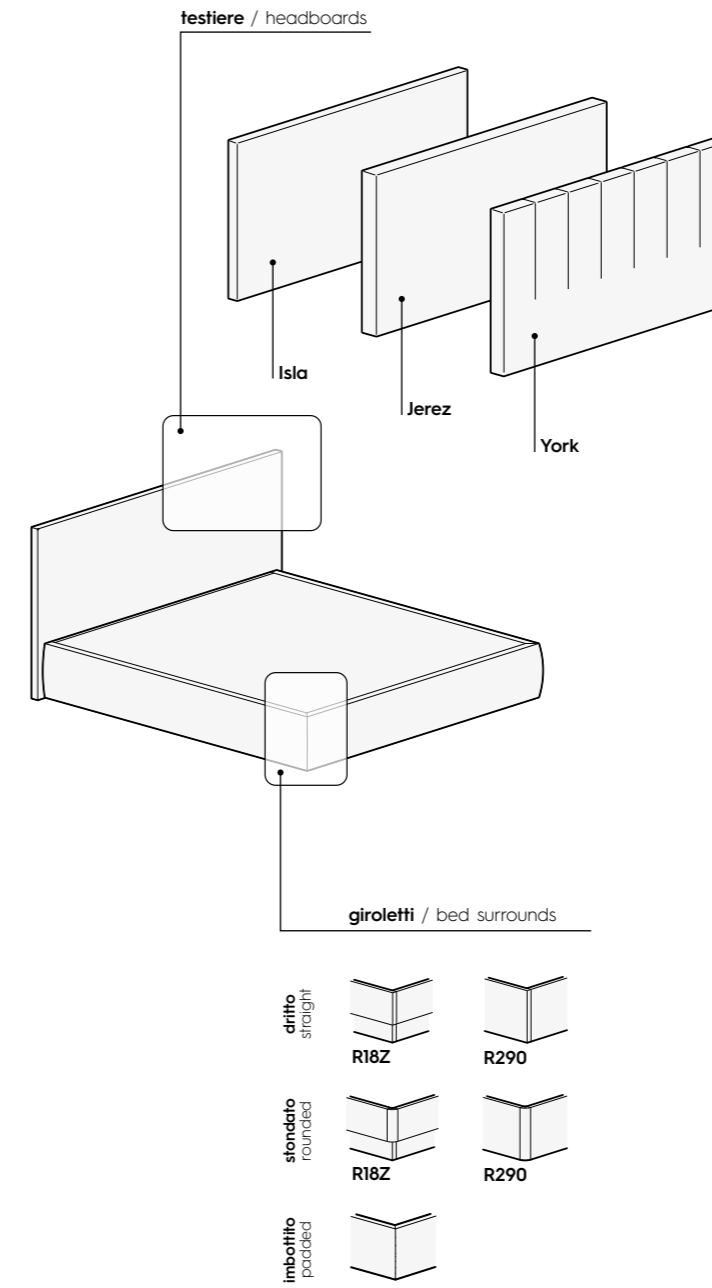

# Letti imbottiti

## Padded beds

Letti imbottiti  
Padded beds

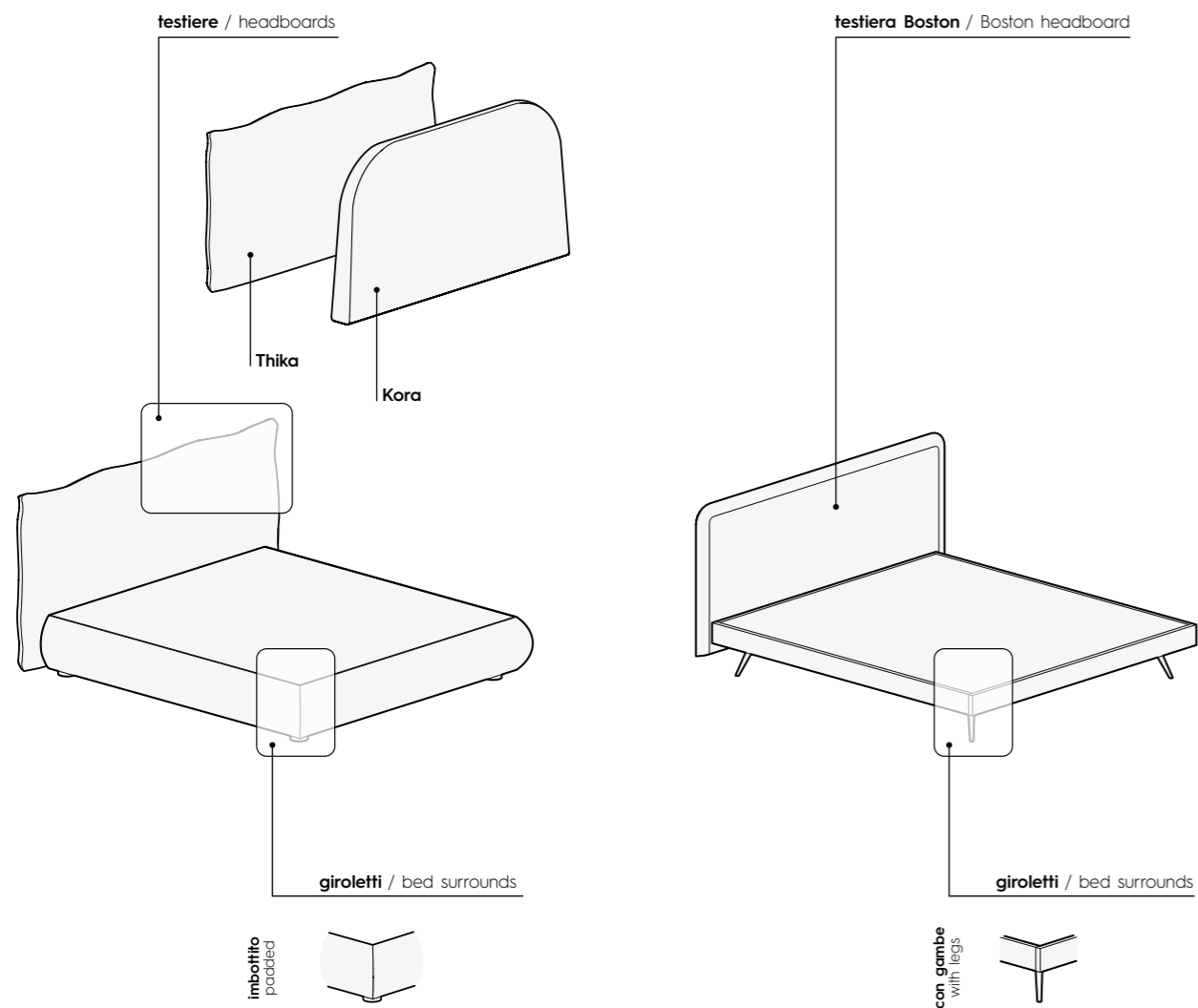

# Turche

## Platform beds

Turca R70 / Platform bed R70

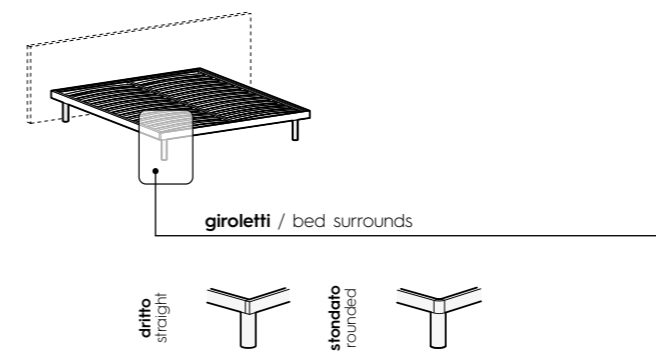

Turca R120 / Platform bed R120

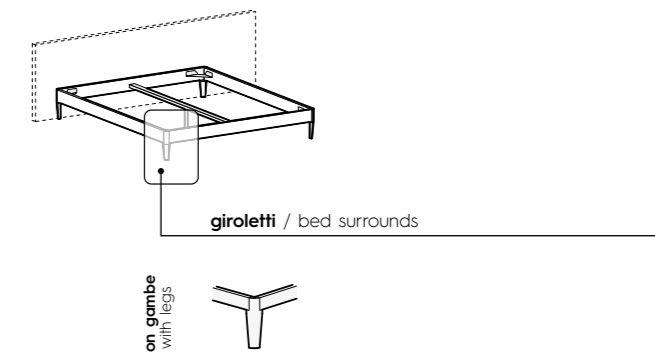

Turca R180 / Platform bed R180

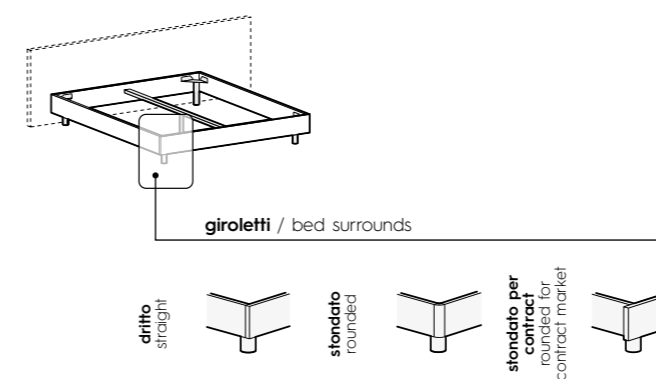

Turca R18Z / Platform bed R18Z

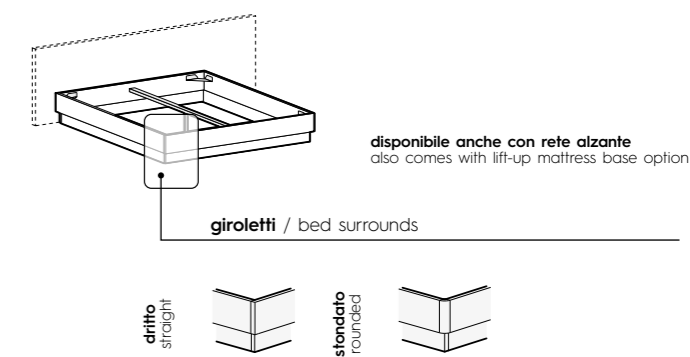

Turca R290 / Platform bed R290

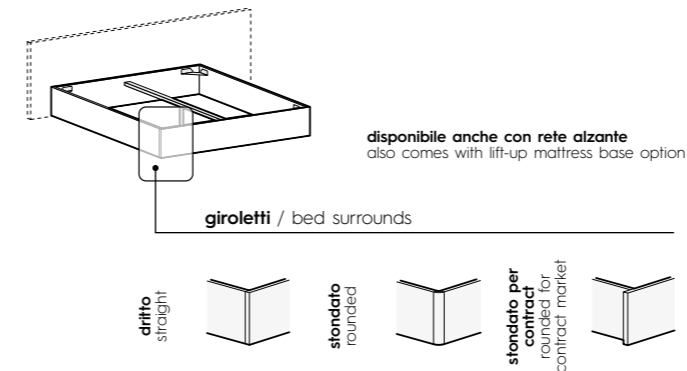

Turca imbottita / Padded platform bed

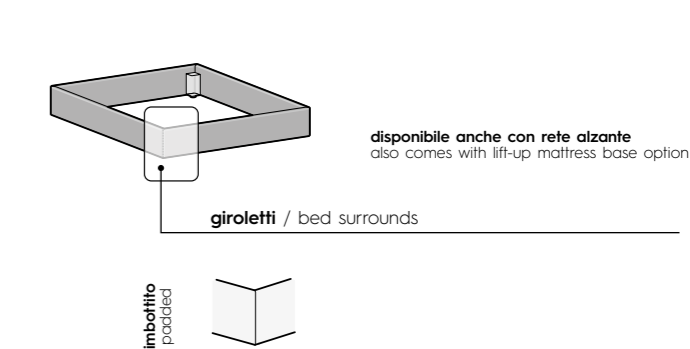



# Letti in nobilitato

## Beds in foil-wrapped finish

### Este



**L x P x H / W x D x H**  
128/148/158/168/188 x 206/216/234 x 95/97 cm

**Giroletti / Bed surrounds**

**tutti i giroletti (escluso imbottito)**  
all bed surrounds (except padded options)

**Finiture / Finishes**

**finiture basic e smart (escluso finiture materiche su raccordo stondato)**  
basic and smart finishes (except textured finishes on rounded corner piece)

**Immagine: giroletto e finiture**  
Pictured: bed surround and finishes

**R70 stondato / rounded R70**  
**sabbia / sabbia**

**Presente a pag. / Featured on page**  
183

### Mostar



**L x P x H / W x D x H**  
158/168 x 206/216/234 x 95/97 cm

**Giroletti / Bed surrounds**

**tutti i giroletti (escluso imbottito)**  
all bed surrounds (except padded options)

**Finiture / Finishes**

**finiture basic e smart (escluso finiture materiche su testiera e raccordo stondato)**  
basic and smart finishes (except textured finishes on headboard and rounded corner piece)

**Immagine: giroletto e finiture**  
Pictured: bed surround and finishes

**R180 dritto / straight R180**  
**basalto / basalto**

**Presente a pag. / Featured on page**  
150

### Lagos



**L x P x H / W x D x H**  
128/158/168/188 x 206/216/234 x 95/97 cm

**Giroletti / Bed surrounds**

**tutti i giroletti (escluso imbottito)**  
all bed surrounds (except padded options)

**Finiture / Finishes**

**tutti i tessuti e le finiture basic e smart (escluso finiture materiche su raccordo stondato)**  
all fabrics and basic and smart finishes (except textured finishes on rounded corner piece)

**Immagine: giroletto e finiture**  
Pictured: bed surround and finishes

**R290 stondato / rounded R290**  
**frassino chiaro, thick T529**  
frassino chiaro, thick T529

**Presente a pag. / Featured on page**  
170

### Suez



**L x P x H / W x D x H**  
128/148/158/168/188 x 206/216/234 x 90/92 cm

**Giroletti / Bed surrounds**

**tutti i giroletti (escluso imbottito)**  
all bed surrounds (except padded options)

**Finiture / Finishes**

**tutte le finiture basic e smart (escluso finiture materiche su raccordo stondato)**  
all fabrics and basic and smart finishes (except textured finishes on rounded corner piece)

**Immagine: giroletto e finiture**  
Pictured: bed surround and finishes

**R120 / R120**  
**noce naturale / noce naturale**

**Presente a pag. / Featured on page**  
156

# Letti in nobilitato

## Beds in foil-wrapped finish

### Suez Maxi



**L x P x H / W x D x H**  
128/148/158/168/188 x 206/216/234 x 90/92 cm

**Giroletti / Bed surrounds**  
**tutti i giroletti (escluso imbottito)**  
all bed surrounds (except padded options)

**Finiture / Finishes**  
**finiture basic e smart (escluso finiture materiche su raccordo stondato)**  
basic and smart finishes (except textured finishes on rounded corner piece)

**Immagine: giroletto e finiture**  
Pictured: bed surround and finishes

**R18Z stondato / rounded R18Z canapa / canapa**

### Zurigo



**L x P x H / W x D x H**  
158/168 x 206/216/234 x 95/97 cm

**Giroletti / Bed surrounds**  
**tutti i giroletti (escluso imbottito)**  
all bed surrounds (except padded options)

**Finiture / Finishes**  
**finiture basic e smart (escluso finiture materiche su testiera e raccordo stondato)**  
basic and smart finishes (except textured finishes on headboard and rounded corner piece)

**Immagine: giroletto e finiture**  
Pictured: bed surround and finishes

**R70 dritto / straight R70 cemento / cemento**

**Presente a pag. / Featured on page**  
137

### Thun



**L x P x H / W x D x H**  
158/168 x 206/216/234 x 95/97 cm

**Giroletti / Bed surrounds**  
**tutti i giroletti (escluso imbottito)**  
all bed surrounds (except padded options)

**Finiture / Finishes**  
**finiture basic e smart (escluso finiture materiche su testiera e raccordo stondato)**  
basic and smart finishes (except textured finishes on headboard and rounded corner piece)

**Immagine: giroletto e finiture**  
Pictured: bed surround and finishes

**R180 stondato / rounded R180 rovere cotto, gambe nichel**  
rovere cotto, nichel legs



# Letti imbottiti

## Padded beds

### Boston



**L x P x H** / W x D x H  
171/191 x 205/215 x 97 cm

**Tessuti** / Fabrics  
**tutti i tessuti** / all fabrics

**Immagine: finiture** / Pictured: finishes  
**spot T543, fettuccia CC14, gambe lavagna**  
spot T543, CC14 piping, legs in lavagna

**Presente a pag.** / Featured on page  
140

### Kora



**L x P x H** / W x D x H  
178/198 x 216/226 x 97 cm

**Tessuti** / Fabrics  
**tutti i tessuti** / all fabrics

**Immagine: tessuti** / Pictured: fabrics  
**soft T568** / soft T568

**Presente a pag.** / Featured on page  
180

### Isla



**L x P x H** / W x D x H  
128/131/168/171/188/191 x 205/215 x 88/89 cm

**Giroletti** / Bed surrounds  
**imbottito, R18Z dritto e stondato, R290 dritto e stondato**  
padded, straight and rounded R18Z, straight and rounded R290

**Finiture** / Finishes  
**tutti i tessuti e le finiture basic e smart (escluso finiture materiche su raccordo stondato)**  
all fabrics and basic and smart finishes (except textured finishes on rounded corner piece)

**Immagine: giroletto e finiture**  
Pictured: bed surround and finishes  
**R18Z dritto** / straight R18Z  
**calce, cross T512** / calce, cross T512

### Jerez



**L x P x H** / W x D x H  
128/138/168/178/188/198 x 209/213/219/223 x 89/91 cm

**Giroletti** / Bed surrounds  
**imbottito, R18Z dritto e stondato, R290 dritto e stondato**  
padded, straight and rounded R18Z, straight and rounded R290

**Finiture** / Finishes  
**tutti i tessuti e le finiture basic e smart (escluso finiture materiche su raccordo stondato)**  
all fabrics and basic and smart finishes (except textured finishes on rounded corner piece)

**Immagine: giroletto e finiture**  
Pictured: bed surround and finishes  
**R290 stondato** / rounded R290  
**sabbia, thick T530** / sabbia, thick T530

**Presente a pag.** / Featured on page  
172

# Letti imbottiti

## Padded beds

Thika



**L x P x H / W x D x H**  
178/198 x 218/228 x 94 cm

**Tessuti / Fabrics**  
tutti i tessuti / all fabrics

**Immagine: tessuti / Pictured: fabrics**  
soft T567 / soft T567

**Presente a pag. / Featured on page**  
147

York



**L x P x H / W x D x H**  
168/178/198 x 208/212/218/222 x 92 cm

**Gioielli / Bed surrounds**  
imbottito, R18Z dritto e stondato, R290 dritto e stondato  
padded, straight and rounded R18Z, straight and rounded R290

**Finiture / Finishes**  
tutti i tessuti e le finiture basic e smart (escluso finiture materiche su raccordo stondato)  
all fabrics and basic and smart finishes (except textured finishes on rounded corner piece)

**Immagine: tessuti / Pictured: fabrics**  
cross T515 / cross T515

**Presente a pag. / Featured on page**  
169

# Testiere a muro

## Wall-mounted headboards

Cardiff



**L x P x H / W x D x H**  
0-290/290-580 x 5 x 73/93/113 cm

**Gioielli / Bed surrounds**  
tutte le Turche / all platform beds

**Finiture / Finishes**  
finiture basic e smart  
basic and smart finishes

**Immagine: giroletto e finiture**  
Pictured: bed surround and finishes

**Turca R180 dritto / straight R180 platform bed**  
olmo shade / olmo shade

**Presente a pag. / Featured on page**  
160

**Esempio di composizione fino a L 290 cm**  
Example of configuration up to 290 cm wide



**Immagine: giroletto e finiture / Pictured: bed surround and finishes**  
**Turca R180 dritto / straight R180 platform bed**  
cashmere, basalto / cashmere, basalto

**Esempio con doppia altezza**  
Example with two heights



**Immagine: giroletto e finiture / Pictured: bed surround and finishes**  
**Turca R180 dritto / straight R180 platform bed**  
cemento, spot T544 / cemento, spot T544

**Esempio di composizione oltre L 290 fino a L 580 cm (2 pezzi)**  
Example of configuration over 290 cm wide up to 580 cm wide (2 parts)



**Immagine: giroletto e finiture / Pictured: bed surround and finishes**  
**Turca R180 dritto / straight R180 platform bed**  
rovere cotto / rovere cotto



**Immagine: giroletto e finiture / Pictured: bed surround and finishes**  
**Turca R180 dritto / straight R180 platform bed**  
calce / calce



# Testiere a muro

## Wall-mounted headboards

Arnad



**L x P x H / W x D x H**  
60/90/120 x 2,9 x 36,3/73,2/91,5/109,8 cm

**Gioielli / Bed surrounds**  
**tutte le Turche / all platform beds**

**Finiture / Finishes**  
**tutti i tessuti e le finiture basic e smart**  
all fabrics and basic and smart finishes

**Immagine: giroletto e finiture**  
Pictured: bed surround and finishes  
**Turca imbottita / Padded platform bed**  
**basalto, soft T561 / basalto, soft T561**

**Presente a pag. / Featured on page**  
133, 187

Esempi di composizione / Examples of configuration



**Immagine: giroletto e finiture** / Pictured: bed surround and finishes  
**Turca R70 stonato / rounded R70 platform bed**  
**lavagna, spot T544 / lavagna, spot T544**



**Immagine: giroletto e finiture** / Pictured: bed surround and finishes  
**Turca R70 stonato / rounded R70 platform bed**  
**canapa, thick T530 / canapa, thick T530**



**Immagine: giroletto e finiture** / Pictured: bed surround and finishes  
**Turca R70 stonato / rounded R70 platform bed**  
**noce naturale, cross T500, gambe nuvola**  
noce naturale, cross T500, nuvola legs



**Immagine: giroletto e finiture** / Pictured: bed surround and finishes  
**Turca R70 stonato / rounded R70 platform bed**  
**cemento, smooth T157, gambe nichel**  
cemento, smooth T157, nichel legs



**Immagine: giroletto e finiture** / Pictured: bed surround and finishes  
**Turca R70 stonato / rounded R70 platform bed**  
**olmo shade, cross T502, gambe nuvola**  
olmo shade, cross T502, nuvola legs



**Immagine: giroletto e finiture** / Pictured: bed surround and finishes  
**Turca R70 stonato / rounded R70 platform bed**  
**frassino chiaro, soft T563-568, gambe cashmere**  
frassino chiaro, soft T563-568, cashmere legs

# Librerie con meccanismo ribaltabile

## Bookcases with drop-down mechanism

### Libreria con letto ribaltabile

Bookcase with drop-down bed



P / D  
33/43 cm



P / D  
209/219/229 cm

**Libreria** / Bookcase  
L x P x H / W x D x H  
132,6/172,6 x 33/43 x  
203/221,3/239,6/257,9/294,5 cm

**Rete** / Mattress base  
L x P / W x D  
120/160 x 190/200 cm

**Finiture** / Finishes  
**finiture basic e smart**  
basic and smart finishes

**Finiture immagine** / Finishes pictured  
**bianco** / bianco

### Libreria con letto ribaltabile con tavolo

Bookcase with drop-down bed with table



P / D  
40/50 cm



P / D  
194/204 cm

**Libreria** / Bookcase  
L x P x H / W x D x H  
172,6 x 33/43 x 221,3/239,6/257,9/294,5 cm

**Finiture** / Finishes  
**finiture basic e smart**  
basic and smart finishes

**Finiture immagine** / Finishes pictured  
**basalto, rovere cotto**  
basalto, rovere cotto

**Presente a pag.** / Featured on page  
127

### Libreria con letto ribaltabile, divano e mensola

Bookcase with drop-down bed, sofa and shelf



P / D  
112/122 cm



P / D  
209/219/229 cm

**Libreria** / Bookcase  
L x P x H / W x D x H  
172,6 x 33/43 x 221,3/239,6/257,9/294,5 cm

**Rete** / Mattress base  
L x P / W x D  
160 x 190/200 cm

**Finiture** / Finishes  
**tutti i tessuti e le finiture basic e smart**  
all fabrics and basic and smart finishes

**Finiture immagine** / Finishes pictured  
**sabbia, spot T550** / sabbia, spot T550

**Presente a pag.** / Featured on page  
121



P / D  
209/219/229 cm

**Rete** / Mattress base  
L x P / W x D  
160 x 190/200 cm

**Finiture** / Finishes  
**finiture basic e smart**  
basic and smart finishes

**Finiture immagine** / Finishes pictured  
**basalto, rovere cotto**  
basalto, rovere cotto

**Presente a pag.** / Featured on page  
127



# Librerie con meccanismo ribaltabile

## Bookcases with drop-down mechanism

### Libreria con letto ribaltabile orizzontale - inferiore

Bookcase with horizontal drop-down bed - bottom section



P / D  
33/43 cm



P / D  
97/107 cm

#### Libreria / Bookcase

L x P x H / W x D x H  
210 x 33/43 x 221,3/239,6/257,9/294,5 cm

#### Rete / Mattress base

L x P / W x D  
80 x 190 cm

#### Finiture / Finishes

**finiture basic e smart**  
basic and smart finishes

#### Finiture immagine / Finishes pictured

**olmo shade** / olmo shade

### Libreria con doppio letto ribaltabile orizzontale

Bookcase with two horizontal drop-down beds



P / D  
33/43 cm



P / D  
110/120 cm

#### Libreria / Bookcase

L x P x H / W x D x H  
210 x 33/43 x 221,3/239,6/257,9/294,5 cm

#### Rete / Mattress base

L x P / W x D  
80 x 190 cm

#### Finiture / Finishes

**finiture basic e smart**  
basic and smart finishes

#### Finiture immagine / Finishes pictured

**noce naturale, sabbia**  
noce naturale, sabbia

### Libreria con letto ribaltabile orizzontale - superiore

Bookcase with horizontal drop-down bed - top section



P / D  
33/43 cm

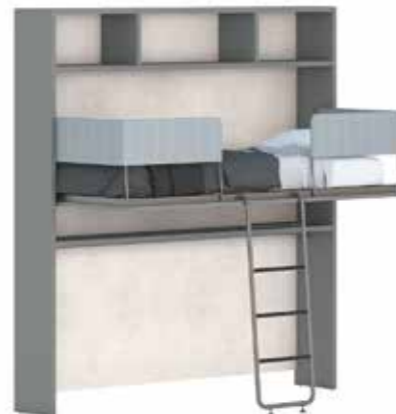

P / D  
110/120 cm

#### Libreria / Bookcase

L x P x H / W x D x H  
210 x 33/43 x 221,3/239,6/257,9/294,5 cm

#### Rete / Mattress base

L x P / W x D  
80 x 190 cm

#### Finiture / Finishes

**finiture basic e smart**  
basic and smart finishes

#### Finiture immagine / Finishes pictured

**cemento, calce** / cemento, calce

# Gruppi letto

## Bedroom units

### Atene



**Comodino**  
Bedside table

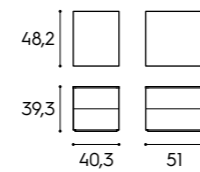

**Comò**  
Chest of drawers

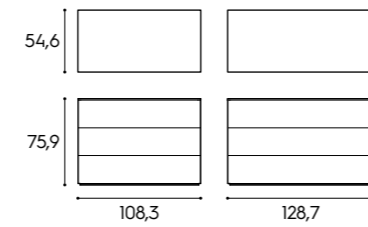

**Settimino**  
Tallboy

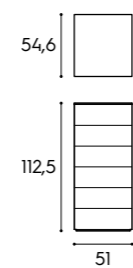

**Finiture / Finishes**

**finiture basic e smart** / basic and smart finishes

**Finiture immagine** / Finishes pictured

**olmo shade** / olmo shade

**Presente a pag.** / Featured on page  
147

### Bonn



**Comodino**  
Bedside table

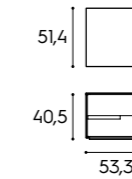

**Comò**  
Chest of drawers

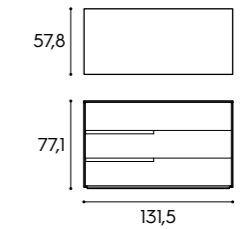

**Settimino**  
Tallboy

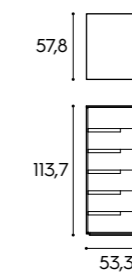

**Finiture / Finishes**

**finiture basic e smart** / basic and smart finishes

**Finiture immagine** / Finishes pictured

**basalto, calce** / basalto, calce

**Presente a pag.** / Featured on page  
188

### Bilbao



**Comodino**  
Bedside table



**Comò**  
Chest of drawers

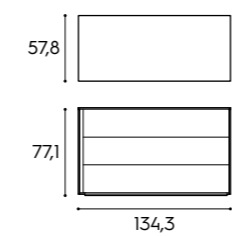

**Settimino**  
Tallboy

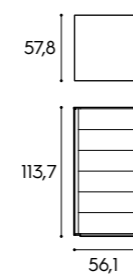

**Finiture / Finishes**

**finiture basic e smart** / basic and smart finishes

**Finiture immagine** / Finishes pictured

**cemento, frassino chiaro** / cemento, frassino chiaro

**Presente a pag.** / Featured on page  
151, 171

### Londra



**Comodino**  
Bedside table

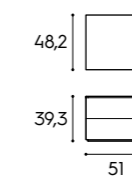

**Comò**  
Chest of drawers

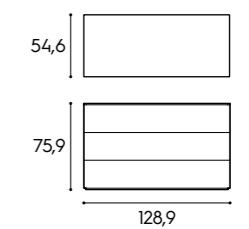

**Settimino**  
Tallboy

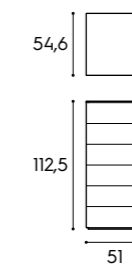

**Finiture / Finishes**

**olmo shade, nuvola, noce naturale, frassino chiaro, rovere cotto**  
olmo shade, nuvola, noce naturale, frassino chiaro, rovere cotto

**Finiture immagine** / Finishes pictured

**nuvola** / nuvola

**Presente a pag.** / Featured on page  
160



# Gruppi letto

## Bedroom units

### Oslo



#### Finiture / Finishes

finiture basic e smart / basic and smart finishes

#### Tutte le maniglie (escluso push-pull)

Any handle options (except push-to-open system)

#### Finiture immagine / Finishes pictured

rovere cotto, cemento / rovere cotto, cemento

Presente a pag. / Featured on page

180

**Comodino**  
Bedside table

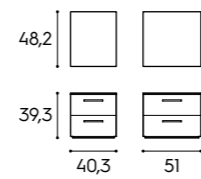

**Comò**  
Chest of drawers

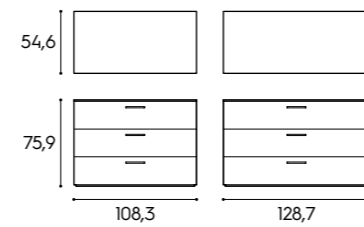

**Settimino**  
Tallboy



### Parigi



#### Finiture / Finishes

finiture basic e smart / basic and smart finishes

#### Finiture immagine / Finishes pictured

noce naturale, lavagna / noce naturale, lavagna

Presente a pag. / Featured on page

137

**Comodino**  
Bedside table

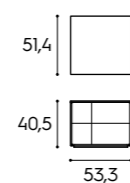

**Comò**  
Chest of drawers

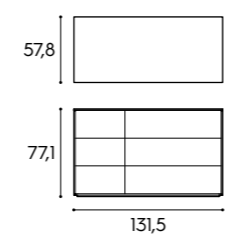

**Settimino**  
Tallboy

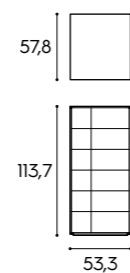

### Praga



#### Finiture / Finishes

finiture basic e smart (escluso finiture materiche ed ecolegno su gambe)  
basic and smart finishes (except textured and eco-wood finishes on legs)

#### Tutte le maniglie (escluso push-pull)

Any handle options (except push-to-open system)

#### Finiture immagine / Finishes pictured

intonaco, cemento / intonaco, cemento

Presente a pag. / Featured on page

183

**Comodino**  
Bedside table

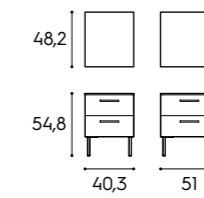

**Comò**  
Chest of drawers



**Settimino**  
Tallboy

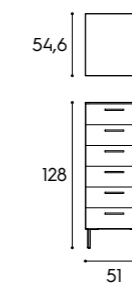

### Tavolino Orig

Orig side table



#### Finiture / Finishes

finiture basic e smart (escluso finiture materiche ed ecolegno su gambe)  
basic and smart finishes (except textured and eco-wood finishes on legs)

#### Finiture immagine / Finishes pictured

cashmere

Presente a pag. / Featured on page

50, 55, 108, 146

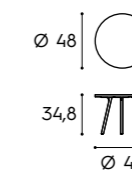

# Scrivanie spessore 3 e 5 cm

## 3 cm- and 5 cm-thick desks

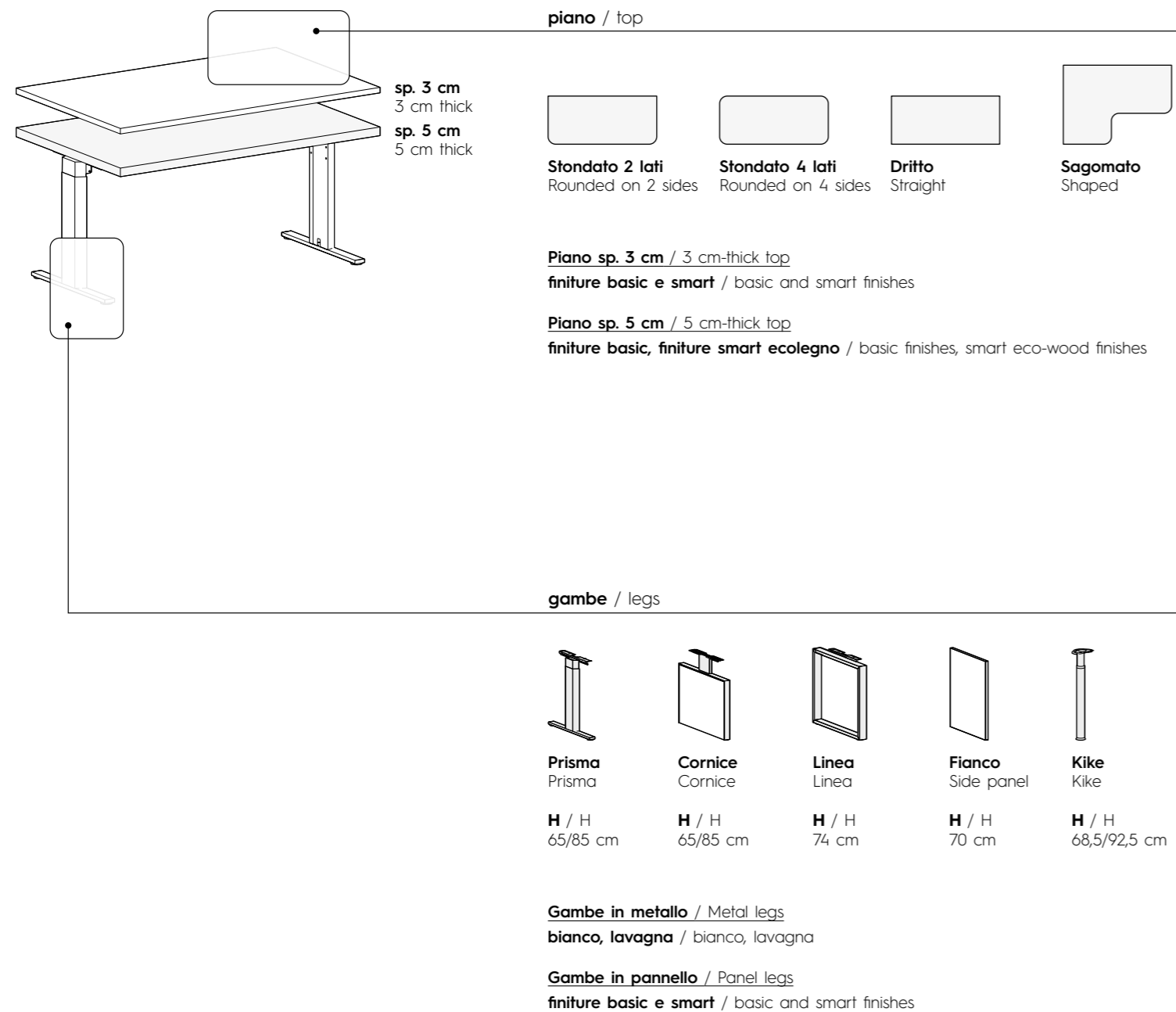

Esempi di composizione / Examples of configuration





# Scrivanie dinamiche

## Sit-stand desks

### Scrivanie dinamiche

Sit-stand desks

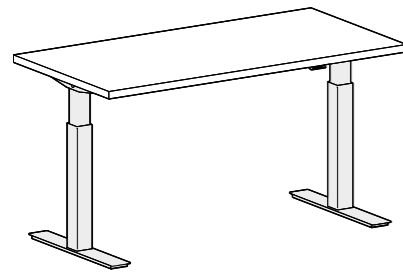

**Piano sp. 3 cm / 3 cm-thick top**  
**finiture basic e smart / basic and smart finishes**

**Gambe in metallo / Metal legs**  
**bianco, lavagna / bianco, lavagna**

**Finiture immagine / Finishes pictured**  
**bianco / bianco**

**Dimensioni / Dimensions**  
**L / W**                      **P / D**                      **H / H**  
 160/180 cm                  80/100 cm                  min. 70 cm, max. 116 cm

### Esempi di composizione / Examples of configuration

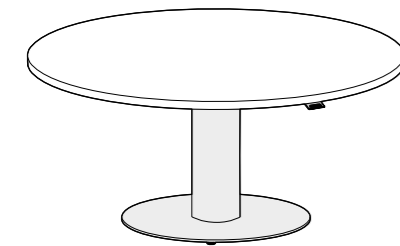

**Piano sp. 3 cm / 3 cm-thick top**  
**finiture basic e smart / basic and smart finishes**

**Gambe in metallo / Metal legs**  
**bianco, lavagna / bianco, lavagna**

**Finiture immagine / Finishes pictured**  
**bianco / bianco**

**Dimensioni / Dimensions**  
**L / W**                      **H / H**  
 130/150 cm                  min. 70 cm, max. 116 cm

### Esempi di composizione / Examples of configuration



# Scrivtoi per contract

## Desks for contract market

### Scrivtoi con piano in folding h 7 cm (gambe sp. 3 cm)

Desks with h 7 cm mitre-folded top (legs 3 cm thick)

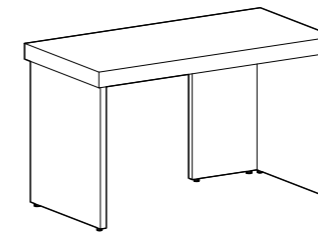

**Finiture / Finishes**  
**finiture basic e smart / basic and smart finishes**

**Dimensioni / Dimensions**  
**L / W**                      **P / D**                      **H / H**  
 120 cm                      60,6 cm                      72 cm

### Scrivtoi e piani di lavoro sp. 3 cm

Desks and worktops 3 cm thick

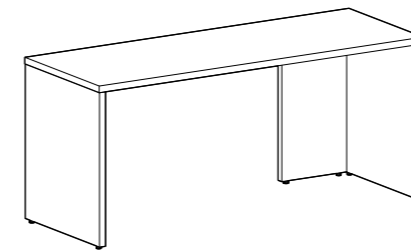

**Finiture / Finishes**  
**finiture basic e smart / basic and smart finishes**

**Dimensioni / Dimensions**  
**L / W**                      **P / D**                      **H / H**  
 165 cm                      45,8/60,6 cm                  73 cm  
 165 cm                      70 cm                      96,2 cm

### Scrivtoi sp. 3 cm con vano per frigo

Desks 3 cm thick with mini-bar cabinet

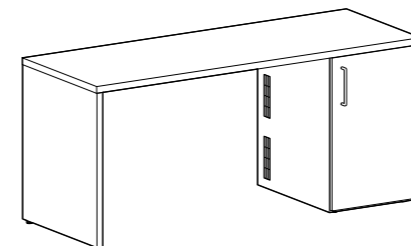

**Finiture / Finishes**  
**finiture basic e smart / basic and smart finishes**

**Dimensioni / Dimensions**  
**L / W**                      **P / D**                      **H / H**  
 165 cm                      60,6 cm                      73 cm

# Piani sospesi con alzata

## Wall-mounted tops with upstand

**Piani sospesi con alzata**  
Wall-mounted tops with upstand

**Piano disponibile / Top options**



**Stondato 2 lati**  
Rounded on 2 sides



**Stondato 1 lato**  
Rounded on 1 side



**Dritto**  
Straight

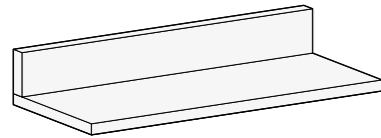

**Piano sp. 5 cm / 5 cm-thick top**  
**finiture basic, finiture smart ecolegno** / basic finishes, smart eco-wood finishes

**Dimensioni / Dimensions**

**L / W** 120/135/150/180 cm    **P / D** 35,8/45,8/61 cm    **H / H** 18,3 cm

**Presente a pag. / Featured on page**  
47, 87, 180, 205

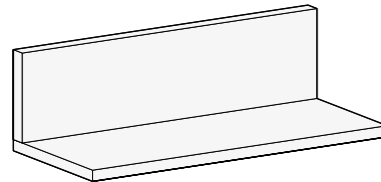

**Piano sp. 5 cm / 5 cm-thick top**  
**finiture basic, finiture smart ecolegno** / basic finishes, smart eco-wood finishes

**Dimensioni / Dimensions**

**L / W** 120/135/150/180 cm    **P / D** 35,8/45,8/61 cm    **H / H** 36,6 cm

**Presente a pag. / Featured on page**  
185

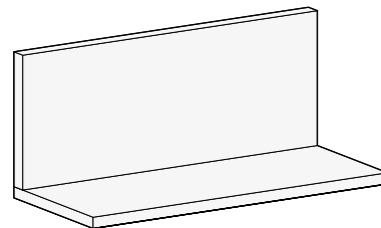

**Piano sp. 5 cm / 5 cm-thick top**  
**finiture basic, finiture smart ecolegno** / basic finishes, smart eco-wood finishes

**Dimensioni / Dimensions**

**L / W** 120/135/150/180 cm    **P / D** 35,8/45,8/61 cm    **H / H** 54,9 cm

**Presente a pag. / Featured on page**  
145, 240

**Esempi di composizione / Examples of configuration**





# Scrivanie spessore 1,2 cm

## 1,2 cm-thick desks

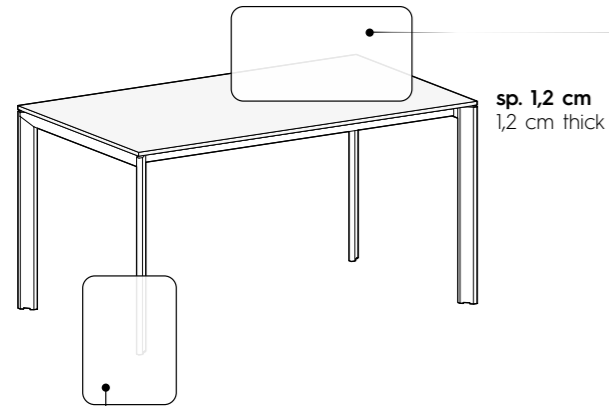

sp. 1,2 cm  
1,2 cm thick

piano / top

**Piano nobilitato sp. 1,2 cm / 1,2 cm-thick foil-wrapped top**  
**finiture basic e smart / basic and smart finishes**

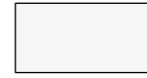

**L x P / W x D**  
120/140/160/180/200/250 x  
60/80/100/120 cm



**Doppio / Double**

**L x P / W x D**  
120/140/160/180/200/250 x 165 cm

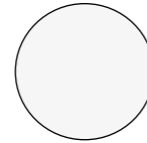

**Circolare / Circular**

**Ø**  
125/145 cm

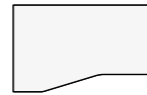

**Sagomato / Shaped**

**L x P / W x D**  
160/180 x 80/100 - 80/120 cm

**Presente a pag. / Featured on page**  
73, 116

**Piano in vetro sp. 1,2 cm / 1,2 cm-thick glass top**

**bianco / bianco**



**L x P / W x D**  
120/140/160/180 x 60 cm  
120/140/160/180/200 x 80 cm  
120/180/200 x 100/120 cm

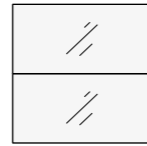

**Doppio / Double**

**L x P / W x D**  
120/140/160/180/200 x 165 cm

gambe / legs

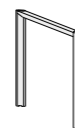

**H / H**  
73,8 cm

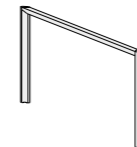

**H / H**  
73,8 cm

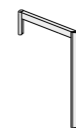

**H / H**  
73,8 cm



**H / H**  
13,3/15,1 cm



**H / H**  
73,8 cm

Esempi di composizione / Examples of configuration



# Tavoli

## Tables

### Lione Small

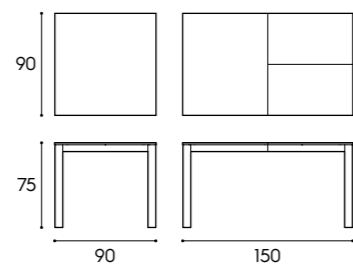

**Piano sp. 1,8 cm** / 1,8 cm-thick top  
**finiture basic e smart** / basic and smart finishes

**Gambe in metallo** / Metal legs  
**bianco, lavagna** / bianco, lavagna

**Finiture immagine** / Finishes pictured  
**bianco** / bianco

### Lione Large

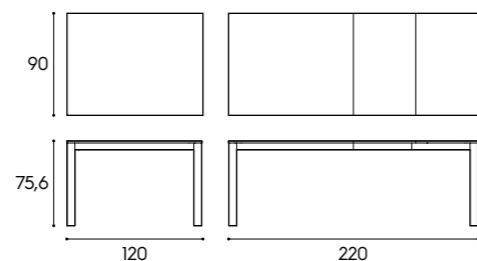

**Presente a pag.** / Featured on page  
 56, 63

**Gambe in metallo** / Metal legs  
**bianco, lavagna** / bianco, lavagna

**Finiture immagine** / Finishes pictured  
**bianco** / bianco

### Corby

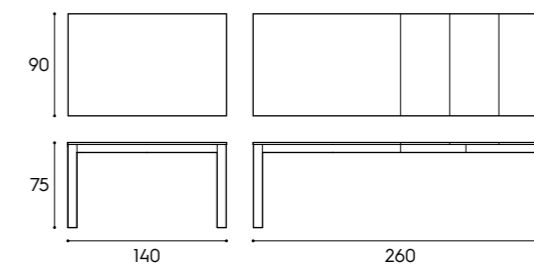

**Piano sp. 1,8 cm** / 1,8 cm-thick top  
**finiture basic e smart** / basic and smart finishes

**Gambe in metallo** / Metal legs  
**bianco, lavagna** / bianco, lavagna

**Finiture immagine** / Finishes pictured  
**bianco** / bianco

**Presente a pag.** / Featured on page  
 21, 87, 104

### Corby penisola

Corby peninsula

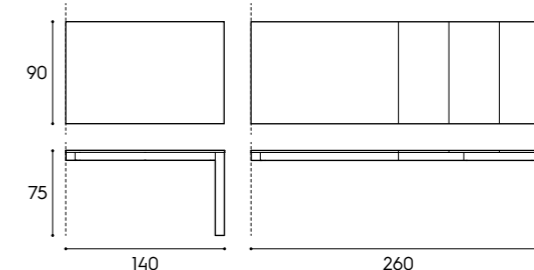
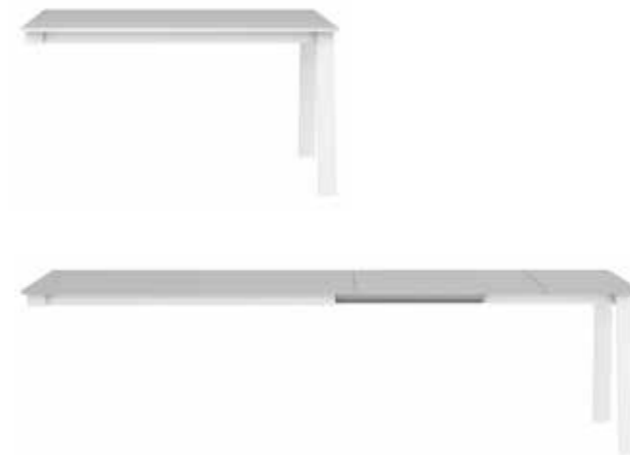

**Piano sp. 1,8 cm** / 1,8 cm-thick top  
**finiture basic e smart** / basic and smart finishes

**Gambe in metallo** / Metal legs  
**bianco, lavagna** / bianco, lavagna

**Finiture immagine** / Finishes pictured  
**bianco** / bianco

**Presente a pag.** / Featured on page  
 49, 77



# Tavoli

## Tables

### Nizza Small

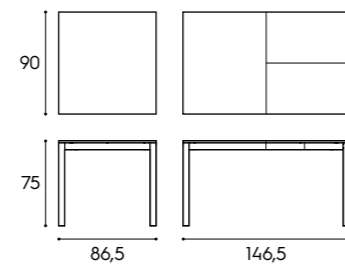

**Piano sp. 1,8 cm** / 1,8 cm-thick top  
**finiture basic e smart** / basic and smart finishes

**Gambe in metallo** / Metal legs  
**bianco, lavagna** / bianco, lavagna

**Finiture immagine** / Finishes pictured  
**bianco** / bianco

### Nizza Large

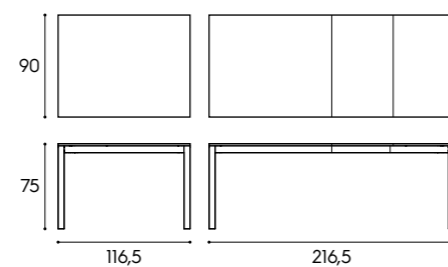

**Piano sp. 1,8 cm** / 1,8 cm-thick top  
**finiture basic e smart** / basic and smart finishes

**Gambe in metallo** / Metal legs  
**bianco, lavagna** / bianco, lavagna

**Finiture immagine** / Finishes pictured  
**bianco** / bianco

### Monaco

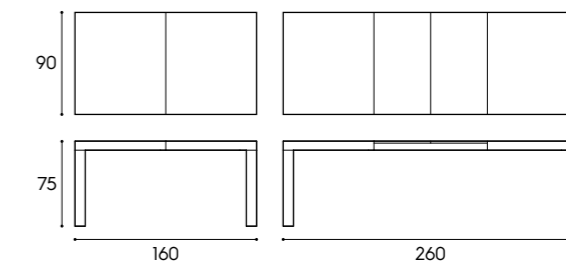

**Finiture** / Finishes  
**calce, intonaco** / calce, intonaco

**Finiture immagine** / Finishes pictured  
**calce** / calce

### Vigo

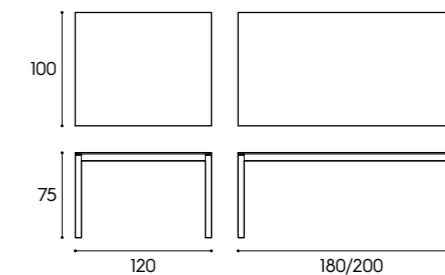

**Piano sp. 1,2 cm** / 1,2 cm-thick top  
**vetro bianco** / white glass

**Gambe in metallo** / Metal legs  
**bianco, lavagna** / bianco, lavagna

**Finiture immagine** / Finishes pictured  
**bianco, vetro bianco** / bianco, white glass

**Presente a pag.** / Featured on page  
 110

# Tavoli

## Tables

**Richiudibile**  
Folding

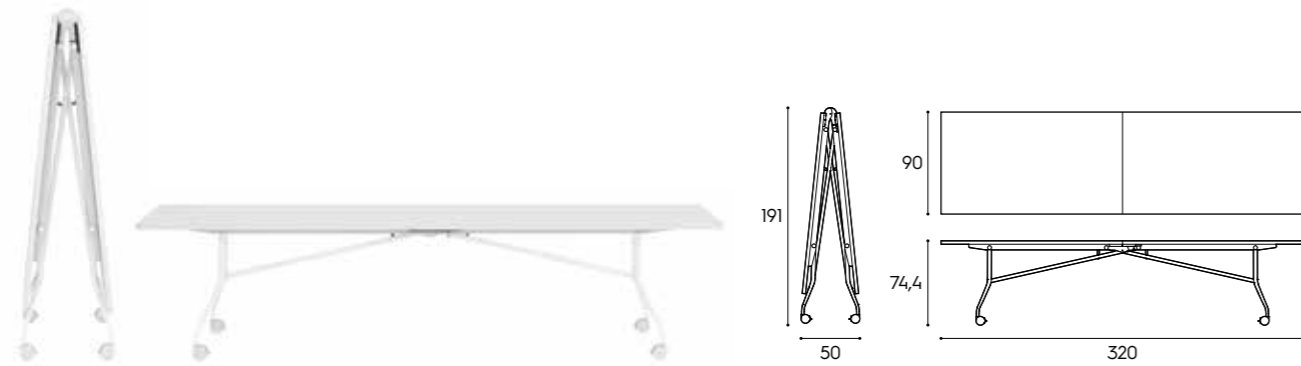

**Piano sp. 3 cm / 3 cm-thick top**  
**finiture basic e smart / basic and smart finishes**

**Gambe in metallo / Metal legs**  
**bianco, lavagna / bianco, lavagna**

**Finiture immagine / Finishes pictured**  
**bianco / bianco**

**Ribaltabile**  
Drop-down



**Piano sp. 1,8 cm / 1,8 cm-thick top**  
**finiture basic e smart / basic and smart finishes**

**Gambe in metallo / Metal legs**

**Finiture immagine / Finishes pictured**  
**bianco / bianco**

# Tavolini

## Occasional tables

**Anversa**

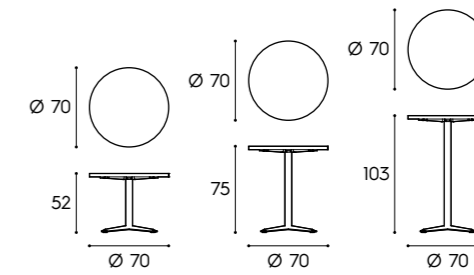

**Piano sp. 1,8 cm / 1,8 cm-thick top**  
**finiture basic e smart / basic and smart finishes**

**Gambe in metallo / Metal legs**  
**bianco, nero / bianco, nero**

**Finiture immagine / Finishes pictured**  
**bianco / bianco**

**Presente a pag. / Featured on page**  
85



# Sedie Chairs

Giant



**Sedia in tecnopolimero**  
Technopolymer chair  
J00, J21, J54 / J00, J21, J54

**Finiture immagine** / Finishes pictured  
J54 / J54

**Presente a pag.** / Featured on page  
65, 127

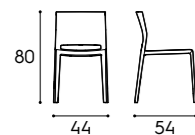

Cork



**Sedia in tecnopolimero**  
Technopolymer chair  
J00 / J00

**Finiture immagine** / Finishes pictured  
J00 / J00

**Presente a pag.** / Featured on page  
73

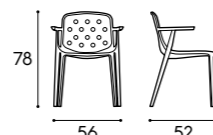

# Sedie imbottite Upholstered chairs

Sneek



**Seduta imbottita** / Upholstered chair  
tutti i tessuti e feltro  
all fabrics and felt

**Basamento R1 in metallo**  
Metal R1 base  
bianco / white

**Finiture immagine** / Finishes pictured  
smooth T175, bianco / smooth T175, white

**Presente a pag.** / Featured on page  
49, 77, 101, 175

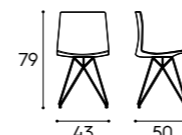

Sneek



**Seduta imbottita** / Upholstered chair  
tutti i tessuti e feltro  
all fabrics and felt

**Basamento R2 in metallo**  
Metal R2 base  
bianco, nero / white, black

**Finiture immagine** / Finishes pictured  
feltro TF23, bianco / felt TF23, white

**Presente a pag.** / Featured on page  
87, 145, 185

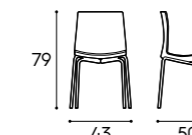

Sneek



**Seduta in tecnopolimero**  
Technopolymer seat  
J00, J10, J23, J36 / J00, J10, J23, J36

**Basamento R1 in metallo**  
Metal R1 base  
bianco / white

**Finiture immagine** / Finishes pictured  
J00 / J00

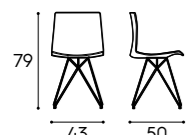

Sneek



**Seduta in tecnopolimero**  
Technopolymer seat  
J00, J10, J23, J36 / J00, J10, J23, J36

**Basamento R2 in metallo**  
Metal R2 base  
bianco, nero / white, black

**Finiture immagine** / Finishes pictured  
J10, nero / J10, black

**Presente a pag.** / Featured on page  
21, 56, 110, 122

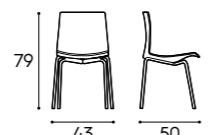

Nerja



**Seduta in ecopelle e gambe in metallo**  
Imitation leather seat and metal legs  
bianco, testa di moro / white, dark brown

**Finiture immagine** / Finishes pictured  
testa di moro / dark brown

**Presente a pag.** / Featured on page  
63, 90, 104, 116

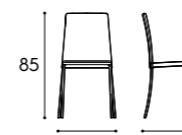

# Sedie su ruote

## Swivel chairs

### Assen



**Struttura / Frame**  
in nylon e rete / in nylon and mesh  
nero / black

**Seduta imbottita / Padded seat**  
tessuti per sedie su ruote  
swivel chair fabrics

**Basamento a 5 razze girevole**  
5-star swivel base  
nero, cromato / black, chrome

**Finiture immagine / Finishes pictured**  
TL32, nero / TL32, black

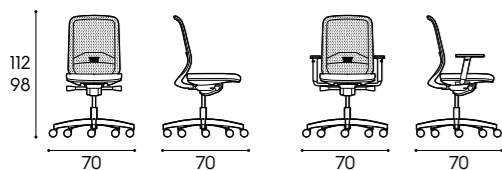

### York



**Struttura / Frame**  
in polipropilene e rete o polipropilene  
in polypropylene and mesh  
or polypropylene  
nero / black

**Seduta imbottita / Padded seat**  
tessuti per sedie su ruote  
swivel chair fabrics

**Basamento a 5 razze girevole**  
5-star swivel base  
nero, cromato / black, chrome

**Finiture immagine / Finishes pictured**  
TL32, nero / TL32, black

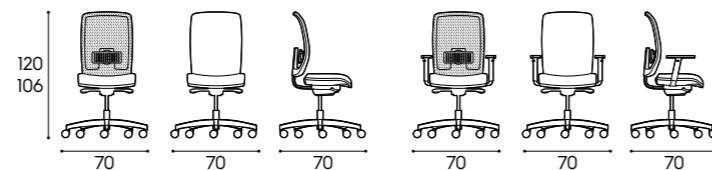

### Basilea



**Struttura / Frame**  
in tecnopolimero / in technopolymer  
nero / black

**Sedia imbottita / Padded chair**  
tessuti per sedie su ruote  
swivel chair fabrics

**Basamento a 5 razze girevole**  
5-star swivel base  
nero, cromato / black, chrome

**Finiture immagine / Finishes pictured**  
TL32, nero / TL32, black

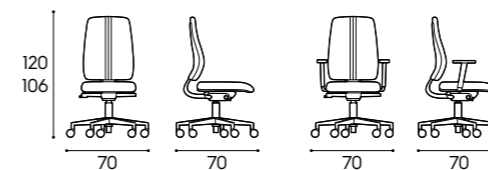

### Montreal



**Struttura / Frame**  
in polipropilene / in polypropylene  
nero / black

**Sedia imbottita / Padded chair**  
tessuti per sedie su ruote  
swivel chair fabrics

**Basamento a 5 razze girevole**  
5-star swivel base  
nero, cromato / black, chrome

**Finiture immagine / Finishes pictured**  
TL32, nero / TL32, black

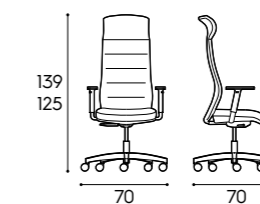

### Sofia



**Struttura / Frame**  
in tecnopolimero e rete  
in technopolymer and mesh  
nero / black

**Seduta imbottita / Padded seat**  
tessuti per sedie su ruote  
swivel chair fabrics

**Basamento a 5 razze girevole**  
5-star swivel base  
nero, cromato / black, chrome

**Finiture immagine / Finishes pictured**  
TL32, nero / TL32, black

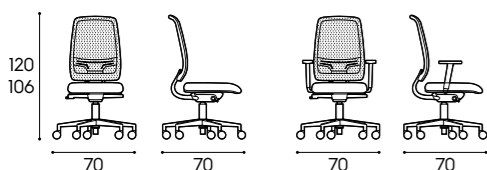

### Laki



**Struttura / Frame**  
in tecnopolimero / in technopolymer  
nero / black

**Sedia imbottita / Padded chair**  
TL30 e TL32 / TL30 and TL32

**Basamento a 5 razze girevole**  
5-star swivel base  
nero / black

**Finiture immagine / Finishes pictured**  
TL32, nero / TL32, black

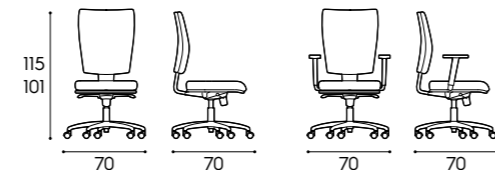

### Nice



**Sedia imbottita / Padded chair**  
tessuti per sedie su ruote  
swivel chair fabrics

**Basamento a 5 razze girevole**  
5-star swivel base  
cromato / chrome

**Finiture immagine / Finishes pictured**  
TL32, cromato / TL32, chrome

**Presente a pag. / Featured on page**  
164

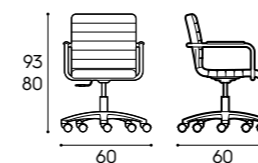

### Cannes



**Sedia imbottita / Padded chair**  
tessuti per sedie su ruote  
swivel chair fabrics

**Basamento a 4 razze girevole**  
4-star swivel base  
nero / black

**Finiture immagine / Finishes pictured**  
TL32, nero / TL32, black

**Presente a pag. / Featured on page**  
37, 74, 143, 180

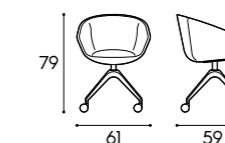



# Sgabelli Stools

## Sneek



**Seduta / Seat**  
in tecnopolimero / in technopolymer  
J00, J10, J23, J36  
J00, J10, J23, J36

**Basamento in metallo**  
Metal base  
bianco, nero / white, black

**Finiture immagine / Finishes pictured**  
J00, bianco / J00, white

**Presente a pag. / Featured on page**  
47

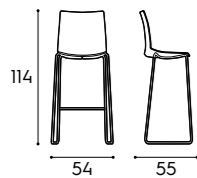

## Helsinki



**Struttura / Frame**  
in tecnopolimero / in technopolymer  
nero / black

**Sedia imbottita / Padded chair**  
tessuti per sedie su ruote  
swivel chair fabrics

**Basamento girevole a 5 razze con poggiatesta**  
5-star swivel base with footrest  
nero / black

**Finiture immagine / Finishes pictured**  
TL31 / TL31

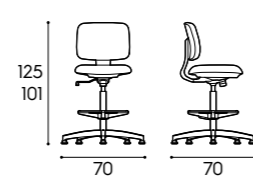

# Lounge e Pouf Lounger chair and Ottoman

## Sneek lounge / lounge chair



**Sedia imbottita / Padded chair**  
tessuti per sedie su ruote e feltro  
swivel chair fabrics and felt

**Basamento in metallo**  
Metal base  
bianco, nero / white, black

**Finiture immagine / Finishes pictured**  
spot T544, nero / spot T544, black

**Presente a pag. / Featured on page**  
35, 78, 88, 102, 151

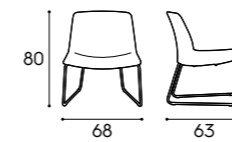

## Tokyo pouf / ottoman



**Struttura / Frame**  
in tecnopolimero / in technopolymer  
nero / black

**Finiture immagine / Finishes pictured**  
TL36 / TL36

**Presente a pag. / Featured on page**  
29, 55, 135, 168, 171

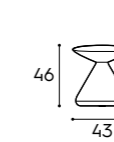

## Harlem



**Struttura / Frame**  
in tecnopolimero / in technopolymer  
nero / black

**Seduta imbottita / Padded seat**  
tessuti per sedie su ruote  
swivel chair fabrics

**Finiture immagine / Finishes pictured**  
TL30 / TL30

**Presente a pag. / Featured on page**  
113

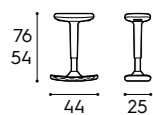

# Divano

## Sofa

### Madrid



**Divano imbottito** / Upholstered sofa

**tutti i tessuti** / all fabrics

**Bordo in contrasto nei colori fettuccia**  
(non disponibile per ecopelle Smooth)

Contrasting piping in any of the piping fabric colours  
(not an option for Smooth imitation leather)

**Immagine: tessuti** / Pictured: fabrics

**spot T542, cenere** / spot T542, cenere

**Presente a pag.** / Featured on page  
55

### Elemento centrale / Central section

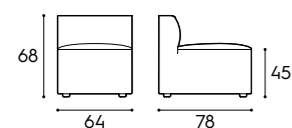

### Elemento laterale o ad angolo / Side or corner section

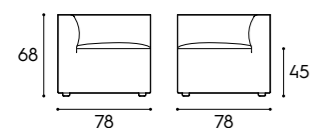

### Pouf / Ottoman

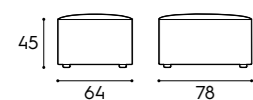

### Esempi di composizione / Examples of configuration



**Immagine: tessuti** / Pictured: fabrics

**cross T512** / cross T512  
**CC11** / CC11



**Immagine: tessuti** / Pictured: fabrics

**soft T563** / soft T563  
**CC13** / CC13

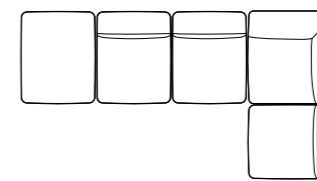

**Immagine: tessuti** / Pictured: fabrics

**thick T522** / thick T522  
**CC10** / CC10

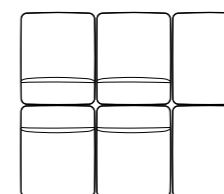

**Immagine: tessuti** / Pictured: fabrics

**smooth T152** / smooth T152

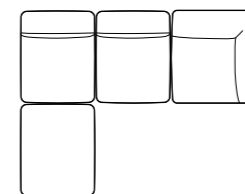



# Accessori elettrici

## Electrical accessories

**Strip LED per fianchi Uniko**  
LED strip for Uniko sides



**Retroilluminazione a LED per testiera Arnad**  
LED backlighting for Arnad headboard

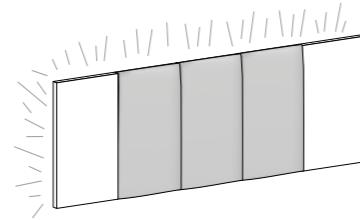

**Lampada LED esterna**  
Surface-mounted LED light



**Finitura / Finish**  
**brunito / bronze**

**Ricarica wireless sottopiano**  
Undermounted wireless charging

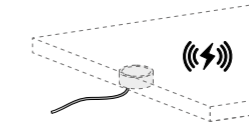

**Luce LED verticale per cabina armadio e a spalla**  
Vertical LED light for walk-in closet and walk-in closet with load-bearing side panels

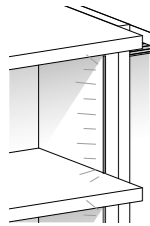

**LED direzionale per testiera Cardiff**  
Directional LED for Cardiff headboard

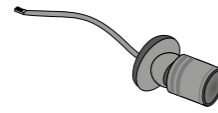

**Finitura in metallo / Metal finish**  
**brunito / bronze**

**Kit faretto LED esterni**  
Surface-mounted LED spotlight kit



**Finitura / Finish**  
**metacrilato / methacrylate**

**Preso da incasso**  
Flush socket

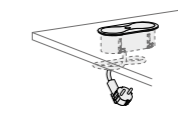

**Finitura in metallo / Metal finish**  
**brunito / bronze**



**chiusa / closed**



**aperta / open**

**Luce LED verticale per armadio e cabina armadio**  
Vertical LED light for wardrobe and walk-in closet

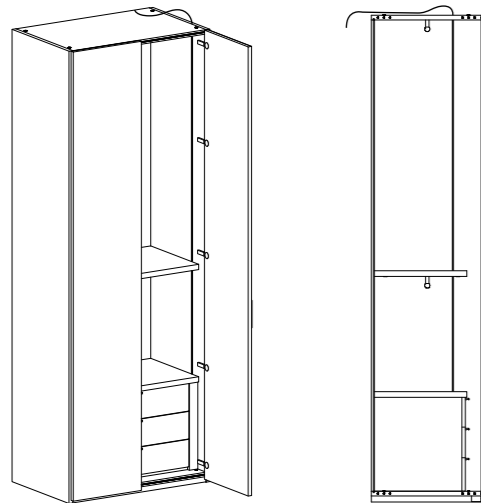

**Strip LED adesiva**  
Adhesive LED strip

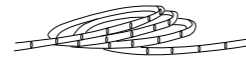

**Consumo singolo / Wattage per light**  
10 W/m 24 V

**Adeguabile a misura**  
Can be adjusted to size

**Lampada LED a batterie ricaricabili**  
LED light with rechargeable batteries

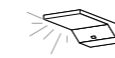

**Finiture / Finishes**  
**bianco, lavagna / bianco, lavagna**

**Luce / Light**  
**warm white / warm white**

## Credits

creative and design director

**Valeria Carlesso**

communication concept and graphic design

**grucciadesign.**

project and set design

**cinquanta3 studio**

digital images

**Helios Digital**

colour separation and print

**Lucegroup**

January 2022

## Cinquanta3

via G. Galilei 35  
31053 Pieve di Soligo  
Treviso – Italia

T +39 0438 83 93  
F +39 0438 83 95 55  
info@cinquanta3.it  
cinquanta3.it

**Battistella spa si riserva in qualsiasi momento la facoltà di apportare tutte le modifiche necessarie al miglioramento funzionale e qualitativo dei propri prodotti. Per ogni aspetto tecnico e dimensionale fare riferimento ai listini aziendali e relativi aggiornamenti. I colori e i materiali riprodotti nelle immagini stampate hanno un valore indicativo. Battistella spa declina ogni responsabilità derivante da eventuali inesattezze di stampa e/o da errori sulle caratteristiche dei prodotti forniti.**

In line with its policy of improving product function and quality, Battistella spa reserves the right to make any necessary changes at any time. For information of a technical and dimensional nature, refer to the company price lists and relevant updates. The colours and materials reproduced in the images printed herein are given as an approximate guide only. Battistella spa does not accept any responsibility for misprints and/or mistakes in describing the characteristics of the products supplied.







# public spaces

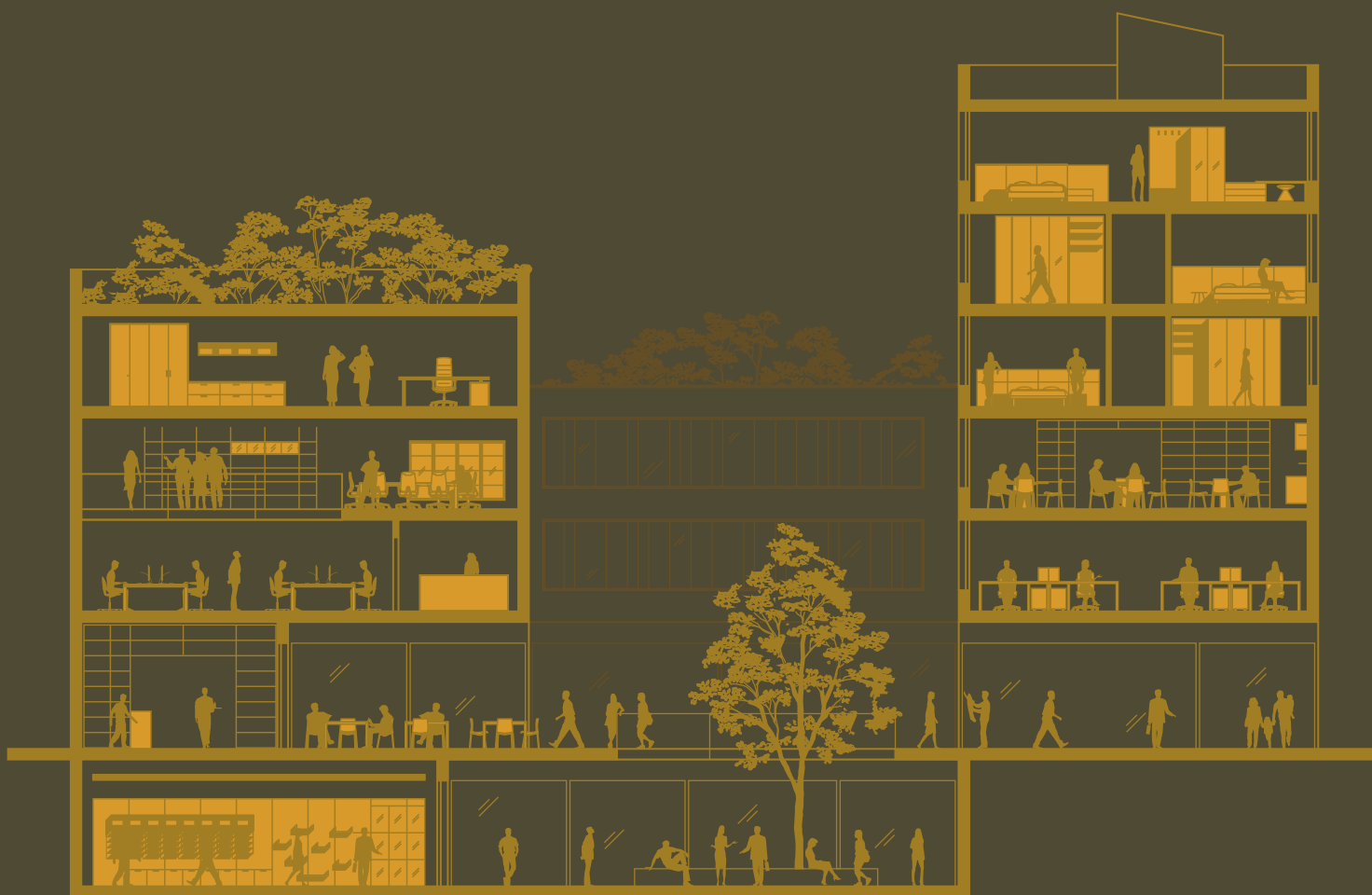

# public spaces



# indice

## index

### il sistema the system

**06** **progettualità**  
about design

### ambienti rooms

#### ufficio / office

- 16** **direzionale**  
executive space
- 44** **operativo**  
workspace
- 94** **open space multifunzionali**  
multifunctional open-plan layout
- 118** **spazi comuni**  
common areas

#### ricezione / accommodation

- 160** **camera hotel**  
hotel room
- 194** **aparthotel**  
serviced apartment
- 220** **reception**  
reception area

#### spazi commerciali / commercial spaces

- 236** **negozio**  
store
- 268** **bistrot**  
bistro

### sezione tecnica technical section

- 288** **finiture e colori**  
finishes and colours
- 290** **tessuti**  
fabrics
- 294** **maniglie**  
handles
- 304** **contenitori**  
storage units
- 308** **librerie**  
bookcases
- 312** **sistema Uniko**  
Uniko system
- 314** **boiserie**  
wall panelling
- 318** **armadi**  
wardrobes
- 326** **cabine**  
walk-in closets
- 330** **letti**  
beds
- 348** **gruppi letto**  
bedroom units
- 352** **scrivanie**  
desks
- 360** **tavoli e sedie**  
tables and chairs

**il sistema**  
the system

# Cinquanta3, il sistema

## Cinquanta3, the system



**Un'ampia gamma di elementi d'arredo modulari, progettati per organizzare in modo funzionale il quotidiano e moltiplicare, con stile, lo spazio ufficio.**

An extensive range of modular items of furniture, designed to organize daily work life in a functional way and multiply office spaces stylishly.



# Cinquanta3, il sistema

## Cinquanta3, the system

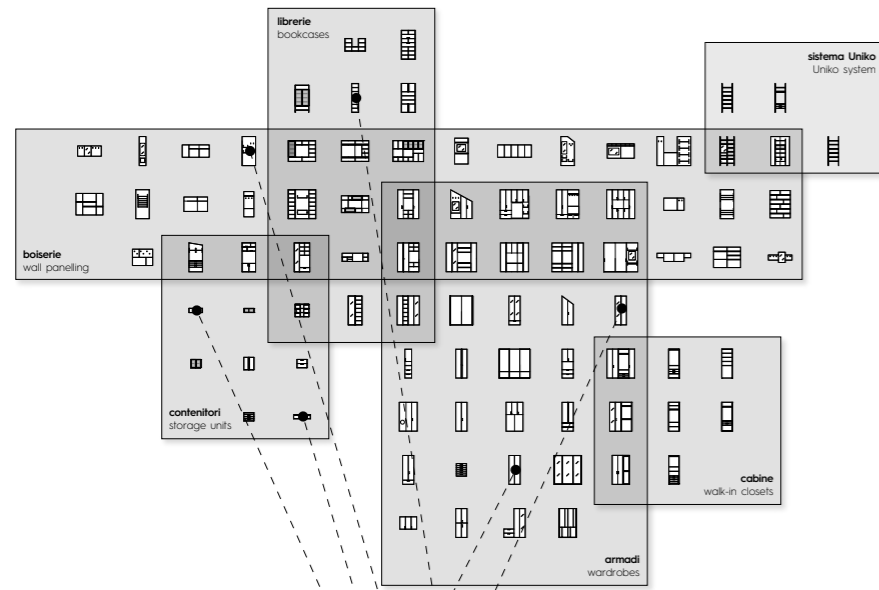

### Nuovi modi di concepire gli ambienti condivisi

New takes on shared spaces

**Gli spazi pubblici si adattano al quotidiano, alle persone che li vivono. Il concetto di dimensione collettiva evolve e si arricchisce di efficienza e ricerca del benessere.**

Public spaces adapt to accommodate daily activities as well as the people who spend time there. The concept of public space is evolving and is enhanced with an injection of efficiency and a focus on wellbeing.

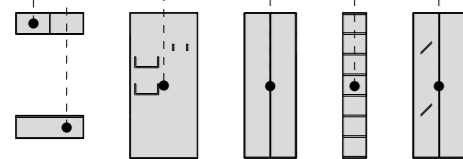

**singoli elementi del sistema**  
individual parts of the system

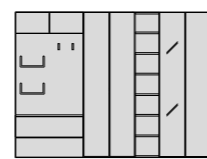
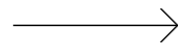

**composizione finita**  
finished configuration

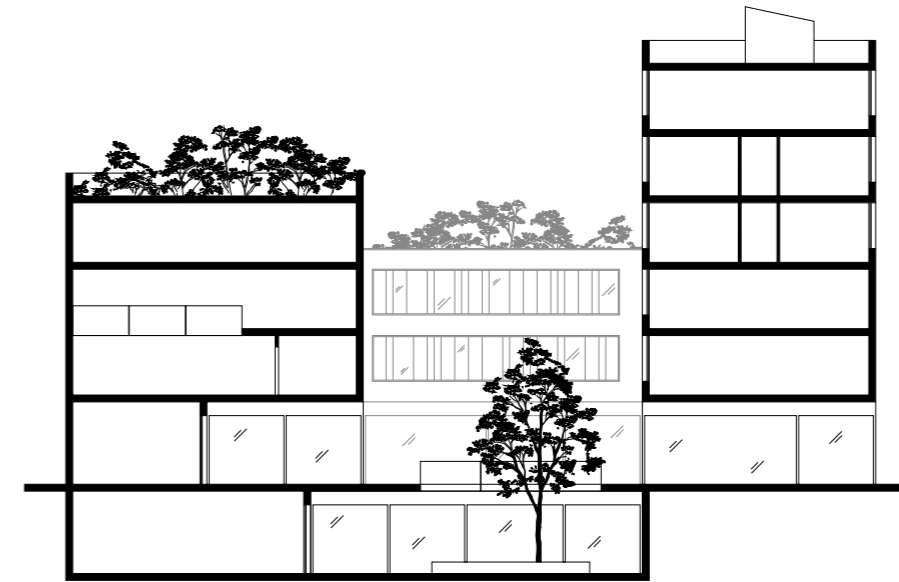

### Soluzioni dedicate all'universo business

Purpose-designed solutions for the business universe

**Elementi modulari e versatili per rispondere all'esigenza di comfort e sicurezza dei moderni uffici e spazi commerciali. Ambienti pubblici altamente ottimizzati che si adattano ai cambiamenti del quotidiano.**

Versatile, modular elements to cater to the comfort and safety needs of modern offices and commercial spaces. Highly optimized public spaces that can adapt to the changing needs of the everyday.

**Ufficio**  
Office

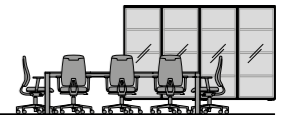

**Ricezione**  
Accommodation



**Spazi commerciali**  
Commercial spaces

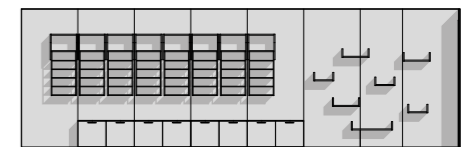

# Progettare il comfort degli spazi funzionali

Building comfort into functional spaces

Flessibilità e comodità caratterizzano i moderni progetti degli spazi pubblici condivisi. Ridisegnare le aree con elementi modulari implementabili, modificabili a seconda delle esigenze. Soluzioni per ambienti sostenibili, piacevoli e salutarì.

Flexibility and comfort are distinguishing traits in the design of shared public spaces. Redesigning areas with modular elements that can be implemented and adapted to suit individual requirements. Solutions for sustainable, enjoyable, healthy interiors.

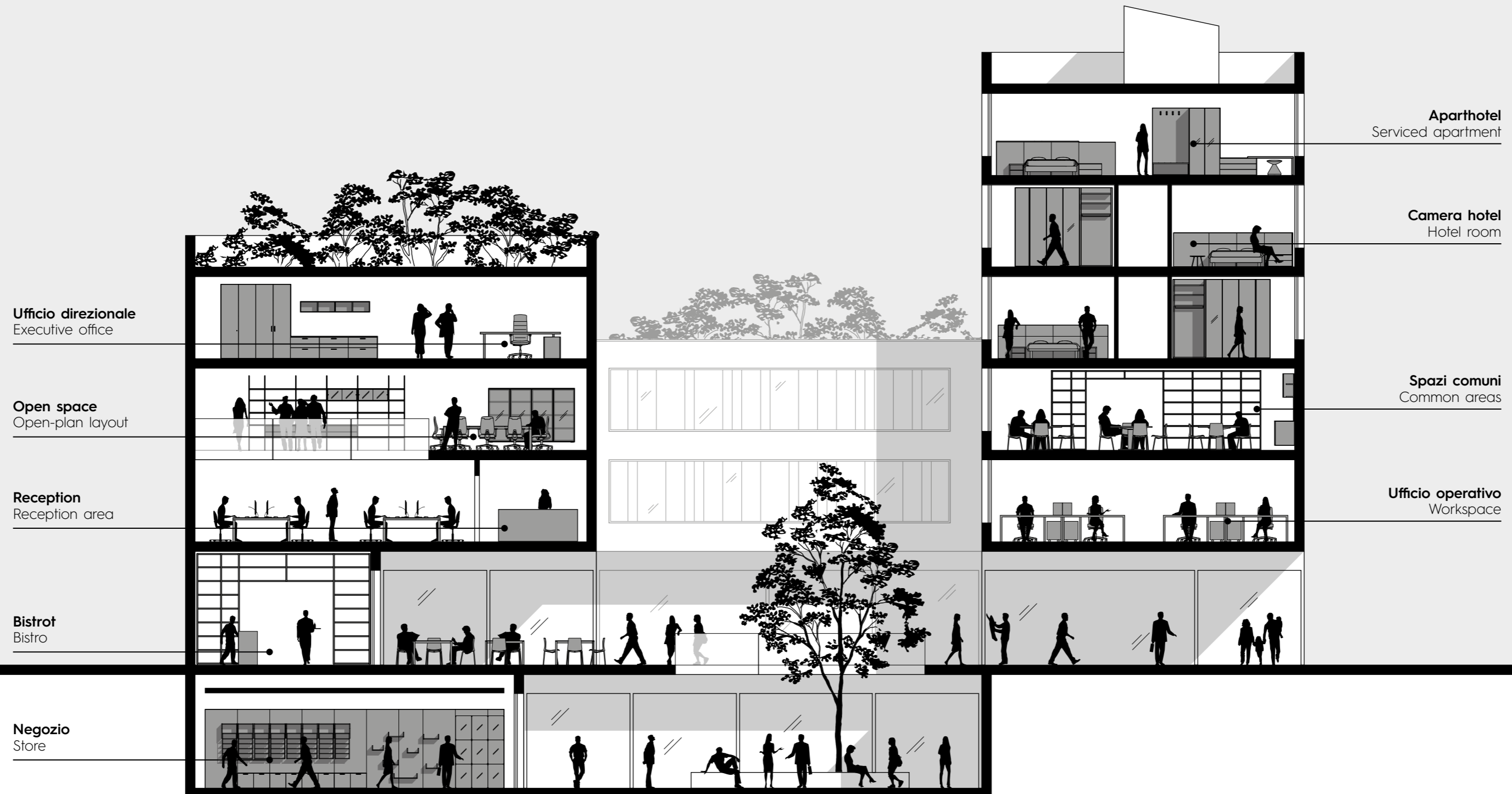

**ambient**  
rooms



**ufficio**  
office

# Un ufficio distinto e organizzato, per dare spazio alla funzionalità

An elegant, organized office, allowing plenty of room for functionality

## ufficio direzionale - S / executive office - S

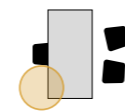

01a - pag. 18



01b - pag. 24



01c - pag. 28

**Un ambiente professionale, che rispecchia le caratteristiche dell'organizzazione. Progettato per unire alla disposizione impeccabile degli elementi uno stile e una personalità che non passano inosservati, per assecondare in modo funzionale le esigenze lavorative del quotidiano.**

A professional space, one that reflects the organization's image and values. Designed to complement the flawless furniture layout with striking style and personality, to cater to everyday work requirements with a functional solution.

## ufficio direzionale - L / executive office - L

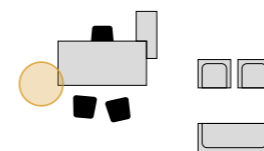

02a - pag. 32



02b - pag. 36



02c - pag. 40

# 01a - 01b - 01c

## Direzionale

### Executive space

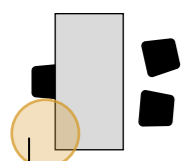

**direzionale - S**  
executive space - S

**Funzionalità ed eleganza si fondono in un ambiente dalle dimensioni contenute, ma di carattere. Uno spazio ottimizzato, dove elementi destinati al contenimento e complementi d'arredo condividono e realizzano un layout dal sapore ricercato e ricco di comfort.**

Function and elegance come together in a space that is small in size but big in character. An optimized space shared by storage units and occasional pieces that produce a layout with a stylish feel and all the comforts of a modern office.





**sedia Montreal / Montreal chair**  
TL32, cromato - pag. 369 / TL32, chrome - page 369

**piano scrivania sp. 5 cm con gambe Cornice**  
5 cm-thick desk top with Cornice legs  
noce naturale, lavagna - pag. 352 / noce naturale, lavagna - page 352

**cassettiera in metallo su ruote / metal drawer unit on castors**  
lavagna / lavagna

**sedie Nice / Nice chairs**  
TL32 - pag. 369 / TL32 - page 369

**scrivania circolare con piano sp. 1,2 cm**  
circular desk with 1,2 cm-thick top  
cemento, lavagna - pag. 358 / cemento, lavagna - page 358

**casellari con crociera / shelving units with pigeon hole**  
cemento / cemento







**parete attrezzata**  
wall system

L / W 543 cm  
H / H 270 cm  
P / D 45,4 cm



**elementi** / elements

**boiserie Arnad** / Arnad wall panelling  
**mensole sp. 5 cm** / 5 cm-thick shelves  
**libreria a terra** / floorstanding bookcase

**finiture** / finishes

**noce naturale** / noce naturale  
**cemento** / cemento



01a - **01b** - 01c  
**Direzionale**  
 Executive space



Ufficio direzionale  
 Executive office

**composizione libreria**  
 bookcase configuration

L / W 543 cm  
 H / H 257,9 cm  
 P / D 45,4 cm

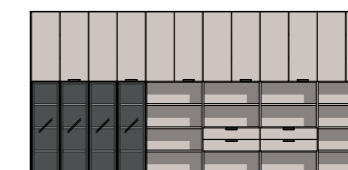

**elementi / elements**  
 libreria a terra / floorstanding bookcase

**finiture / finishes**

cashmere / cashmere  
 vetro fumé / smoked glass  
 lavagna / lavagna

**sedia Montreal / Montreal chair**  
 TL36, nero - pag. 369 / TL36, black - page 369

**sedie Cannes / Cannes chairs**  
 TL36 - pag. 369 / TL36 - page 369

**scrivania con piano in vetro sp. 1,2 cm**  
 desk with 1,2 cm-thick glass top  
 vetro bianco, lavagna - pag. 358 / white glass, lavagna - page 358



**composizione libreria**  
bookcase configuration

L / W 183 cm  
H / H 74,9 cm  
P / D 45,4 cm



**elementi / elements**

**libreria con gambe metalliche**  
bookcase with metal legs

**finiture / finishes**

**rovere cotto / rovere cotto**  
**lavagna / lavagna**



**divano Madrid / Madrid sofa**  
soft T561, fettuccia a contrasto CC10 - pag. 372 / soft T561, CC10 contrasting piping - page 372

# 01a - 01b - 01c

## Direzionale

### Executive space



#### composizione scrivania

desk configuration

L / W 180 cm  
H / H 75 cm  
P / D 250 cm



#### elementi / elements

piano scrivania sp. 5 cm con fianchi / 5 cm-thick desk top with side panels  
basi a terra / floorstanding base units

#### finiture / finishes

frassino chiaro / frassino chiaro  
lavagna / lavagna

#### composizione parete

wall configuration

L / W 180 cm  
H / H 112,7 cm  
P / D 45,8 cm



#### elementi / elements

basi a terra / floorstanding base units

#### finiture / finishes

vetro fumé / smoked glass  
lavagna / lavagna

sedia Basilea con braccioli / Basilea chair with armrests  
TL31, nero - pag. 369 / TL31, black - page 369







**parete attrezzata**  
wall system

L / W 462,6 cm  
H / H 221,3 cm  
P / D 35,8 cm

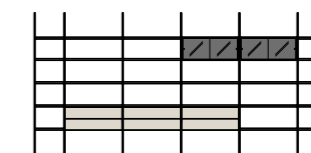

**elementi** / elements  
**sistema Uniko** / Uniko system

**finiture** / finishes  
**frassino chiaro** / frassino chiaro  
**lavagna** / lavagna  
**vetro fumé** / smoked glass

**sedie Sneek imbottite**  
upholstered Sneek chairs  
**TF25, basamento R2 bianco** - pag. 367  
TF25, white R2 base - page 367



# 02a - 02b - 02c

## Direzionale

### Executive space

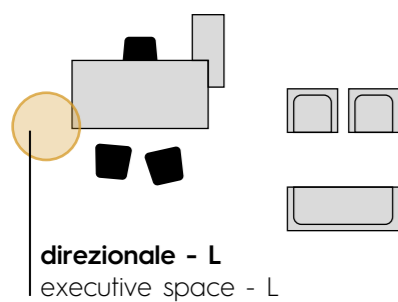

**Un ambiente dalle dimensioni generose, dove ogni elemento trova il proprio spazio nel quotidiano: grazie alla modularità degli elementi, comodità ed efficienza diventano i tratti distintivi del progetto, grazie anche alla ricerca di soluzioni ergonomiche e all'avanguardia.**  
A generously sized space where every element slots into daily office life: with the furniture's modular design, the overall scheme is marked by comfort and efficiency, partly thanks to a focus on ergonomic, cutting-edge solutions.





**composizione libreria**  
bookcase configuration

L / W 243 cm  
H / H 111,5 cm  
P / D 43 cm



**elementi / elements**  
**libreria con gambe metalliche**  
bookcase with metal legs

**finiture / finishes**  
**basalto** / basalto  
**lavagna** / lavagna

**divano Madrid** / Madrid sofa  
cross T513, fettuccia a contrasto CC10 - pag. 372  
cross T513, CC10 contrasting piping - page 372

**sedia Montreal** / Montreal chair  
TL32, nero - pag. 369 / TL32, black - page 369

**sedie Sneek** / Sneek chairs  
J10, basamento R1 - pag. 366  
J10, R1 base - page 366

**piano scrivania sp. 5 cm con gambe Linea**  
5 cm-thick desk top with Linea legs  
**frassino chiaro, lavagna** - pag. 352  
frassino chiaro, lavagna - page 352

**cassettiera in metallo su ruote**  
metal drawer unit on castors  
**lavagna** / lavagna

**composizione armadio**  
wardrobe configuration

L / W 447 cm  
H / H 257,9 cm  
P / D 61 cm

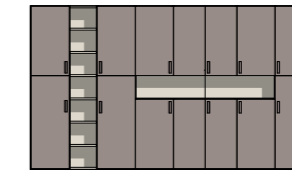

**elementi / elements**

**armadio battente** / hinged door wardrobe  
**libreria a terra** / floorstanding bookcase  
**armadio ponte** / bridging wardrobe  
**basi armadio** / wardrobe base units  
**boiserie Arnad** / Arnad wall panelling

**finiture / finishes**

**basalto** / basalto  
**frassino chiaro** / frassino chiaro





02a - **02b** - 02c

 **Direzionale**  
Executive space



Ufficio direzionale  
Executive office

**composizione libreria**  
bookcase configuration

L / W 363 cm  
H / H 184,5 cm  
P / D 35,4 cm



**elementi / elements**

**libreria sospesa / wall-mounted bookcase**  
**elementi Sudoku / Sudoku units**

**finiture / finishes**

**nuvola / nuvola**

**calce / calce**

**vetro fumé / smoked glass**

**lavagna / lavagna**

**sedia York con braccioli / York chair with armrests**  
TL35, nero - pag. 368 / TL35, black - page 368

**scrivania e penisola con piano sp. 1,2 cm**  
desk and return with 1,2 cm-thick top

**noce naturale, lavagna - pag. 358 / noce naturale, lavagna - page 358**

**cassettiera 3 cassetti con ruote**  
3-drawer unit on castors  
**nuvola / nuvola**



**parete attrezzata**  
wall system

L / W 450 cm  
H / H 294,5 cm  
P / D 49 cm

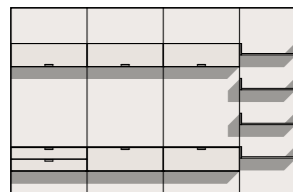

**elementi** / elements

**boiserie Cover** / Cover wall panelling

**pensili** / wall units

**basi sospese** / wall-mounted base units

**componenti Cover** / Cover components

**finiture** / finishes

**calce** / calce

**nuvola** / nuvola

**sedie Cannes** / Cannes chairs

TL35 - pag. 369 / TL35 - page 369

**scrivania circolare con piano sp. 1,2 cm**

circular desk with 1,2 cm-thick top

**nuvola, lavagna** - pag. 358 / nuvola, lavagna - page 358





02a - 02b - **02c**

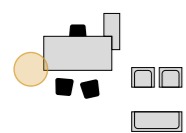

# Direzionale Executive space

## composizione libreria bookcase configuration

L / W 455 cm  
H / H 294,5 cm  
P / D 45,4 cm

L / W 335 cm  
H / H 294,5 cm  
P / D 45,4 cm

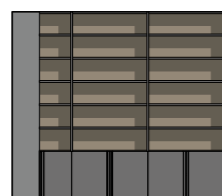
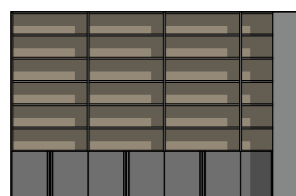

### elementi / elements

libreria a terra e ad angolo  
floorstanding and corner bookcase

### finiture / finishes

cemento / cemento  
rovere cotto / rovere cotto

sedia Laki con braccioli / Laki chair with armrests  
TL32 - pag. 368 / TL32 - page 368

cassettiera in metallo su ruote / metal drawer unit on castors  
lavagna / lavagna



## composizione scrivania desk configuration

L / W 250 cm  
H / H 75 cm  
P / D 208 cm



### elementi / elements

piano scrivania sagomato sp. 3 cm con gambe Cornice  
3 cm-thick shaped desk top with Cornice legs  
piano penisola sagomata sp. 3 cm con gamba Cornice  
3 cm-thick shaped desk return top with Cornice legs

### finiture / finishes

cemento / cemento  
lavagna / lavagna





**sedie Nice** / Nice chairs  
TL31 - pag. 369 / TL31 - page 369

**composizione scrivania**  
desk configuration

L / W 297 cm  
H / H 73 cm  
P / D 120 cm



**elementi** / elements

**piano scrivania sagomato sp. 3 cm con fianchi e schiena**  
3 cm-thick shaped desk top with side panels and back

**finiture** / finishes

**rovere cotto** / rovere cotto



# L'ufficio diventa uno spazio da vivere nel quotidiano

The office becomes a backdrop to everyday life

## ufficio operativo - S / workspace - S

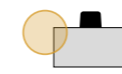

03a - pag. 46



03b - pag. 52



03c - pag. 58

## ufficio operativo - M / workspace - M

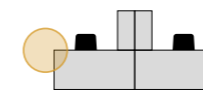

04a - pag. 62



04b - pag. 68



04c - pag. 72



04d - pag. 76

**Il progetto degli spazi operativi richiede al contempo efficienza e vivibilità: il sistema componibile assicura la massima resa sia in uffici singoli o multipli, che nei moderni open space, dove nasce anche l'esigenza di una privacy collaborativa tra le persone.**

Two essential ingredients in the design of workspaces are efficiency and liveability: the modular system ensures top results in individual or shared offices, as well as in modern open-plan spaces that need to be conducive to collaboration while affording workers privacy.

## ufficio operativo - L / workspace - L

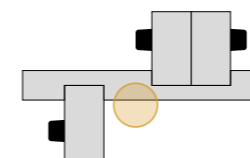

05a - pag. 80



05b - pag. 86



05c - pag. 90

# 03a - 03b - 03c

## Operativo Workspace

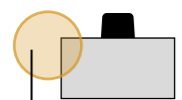

operativo - S  
workspace - S

**Spazio di lavoro ed elementi contenitivi trovano la giusta collocazione in un ambiente che si caratterizza per funzionalità e gusto estetico: attenzione ai dettagli e comodità assicurata dalla modularità degli elementi, concorrono a organizzare l'ufficio e renderlo un luogo piacevole nel quotidiano.**

Workspace and storage units are ideally arranged within an interior that stands out for both function and tasteful aesthetics: attention to detail and the convenience afforded by the furniture's modular design combine to organize the space and make it a pleasant setting for everyday office life.







**piano sospeso con alzata sp. 5 cm**  
5 cm-thick wall-mounted top with upstand  
frassino chiaro - pag. 356 / frassino chiaro - page 356

**composizione scrivania**  
desk configuration

L / W 300 cm  
H / H 77 cm  
P / D 280 cm



**elementi / elements**

**piani scrivania sp. 5 cm con gambe Linea**  
5 cm-thick desk tops with Linea legs  
**raccordo Trio-R sp. 5 cm / 5 cm-thick Trio-R connector**

**finiture / finishes**

**bianco / bianco**

**sedia York rete con braccioli**

York mesh chair with armrests  
**TL30, cromato - pag. 368 / TL30, chrome - page 368**

**sedie Sneek / Sneek chairs**

**J23, basamento R1 - pag. 366**  
J23, R1 base - page 366

**cassettiera in metallo su ruote**

metal drawer unit on castors  
**bianco / bianco**





**composizione armadio**  
wardrobe configuration

L / W 542,5 cm  
H / H 257,9 cm  
P / D 61 cm

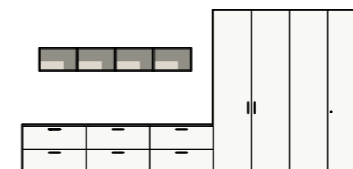

**elementi** / elements  
**armadio battente** / hinged door wardrobe  
**basi armadio** / wardrobe base units  
**casellari** / shelving units

**finiture** / finishes  
**bianco** / bianco  
**frassino chiaro** / frassino chiaro



03a - **03b** - 03c  
**Operativo**  
 Workspace



**sedia Basilea con braccioli**  
 Basilea chair with armrests  
**TL32, nero** - pag. 369  
 TL32, black - page 369  
**sedie Giant** / Giant chairs  
**I54** - pag. 366 / I54 - page 366



Ufficio operativo  
 Workspace

**parete attrezzata**  
 wall system

L / W 480 cm  
 H / H 155 cm  
 P / D 45,8 cm



**elementi** / elements

**pensili** / wall units  
**casellari** / shelving units

**basi sospese** / wall-mounted base units

**finiture** / finishes

**rovere cotto** / rovere cotto  
**sabbia** / sabbia



**composizione scrivania**  
desk configuration

L / W 450 cm  
H / H 75 cm  
P / D 304 cm



**elementi / elements**

**scrivanie con piano sp. 1,2 cm in appoggio**  
desks with 1,2 cm-thick top sitting on units  
**basi a terra / floorstanding base units**

**finiture / finishes**

**rovere cotto / rovere cotto**  
**lavagna / lavagna**  
**sabbia / sabbia**







**composizione parete**  
wall configuration

L / W 540 cm  
H / H 77,9 cm  
P / D 45,8 cm



**elementi** / elements  
**basi a terra** / floorstanding base units

**finiture** / finishes  
**sabbia** / sabbia



# 03a - 03b - 03c

## Operativo Workspace



**mensole ad L / L-shaped shelves**  
noce naturale / noce naturale

**composizione libreria**  
bookcase configuration

L / W 483 cm  
H / H 111,5 cm  
P / D 43 cm



**elementi / elements**  
libreria con gambe metalliche / bookcase with metal legs

**finiture / finishes**  
basalto / basalto  
lavagna / lavagna



**composizione scrivania**  
desk configuration

L / W 240 cm  
H / H 111,5 cm  
P / D 73 cm



**elementi / elements**  
piano scrivania sp. 3 cm con fianchi e schiena  
3 cm-thick desk top with side panels and back

**finiture / finishes**  
noce naturale / noce naturale

**sgabelli Helsinky / Helsinky stools**  
TL36 - pag. 370 / TL36 - page 370

**scrivania dinamica ø 130 cm / sit-stand desk ø 130 cm**  
basalto, lavagna - pag. 354 / basalto, lavagna - page 354





**parete attrezzata**  
wall system

L / W 360,3 cm  
H / H 221,6 cm  
P / D 48,8 cm



**elementi** / elements

**boiserie Cover** / Cover wall panelling  
**pensili** / wall units  
**basi sospese** / wall-mounted base units  
**componenti Cover** / Cover components

**finiture** / finishes

**basalto** / basalto  
**vetro acidato** / etched glass  
**lavagna** / lavagna





# 04a - 04b - 04c - 04d

## Operativo Workspace

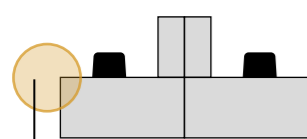

operativo - M  
workspace - M

**Un ambiente, più postazioni, differenti spazi operativi. L'ufficio doppio, triplo o quadruplo richiede una particolare attenzione alla distribuzione degli spazi, condivisi o esclusivi. Aumentano le esigenze di organizzazione e di privacy, perché ogni persona possa svolgere al meglio le proprie attività.**

One room, multiple stations, a variety of workspaces. A two-, three- or four-person office calls for a special focus on how spaces – both shared and private – are set out. There are more organization and privacy requirements to be met so that each person can perform at their best.

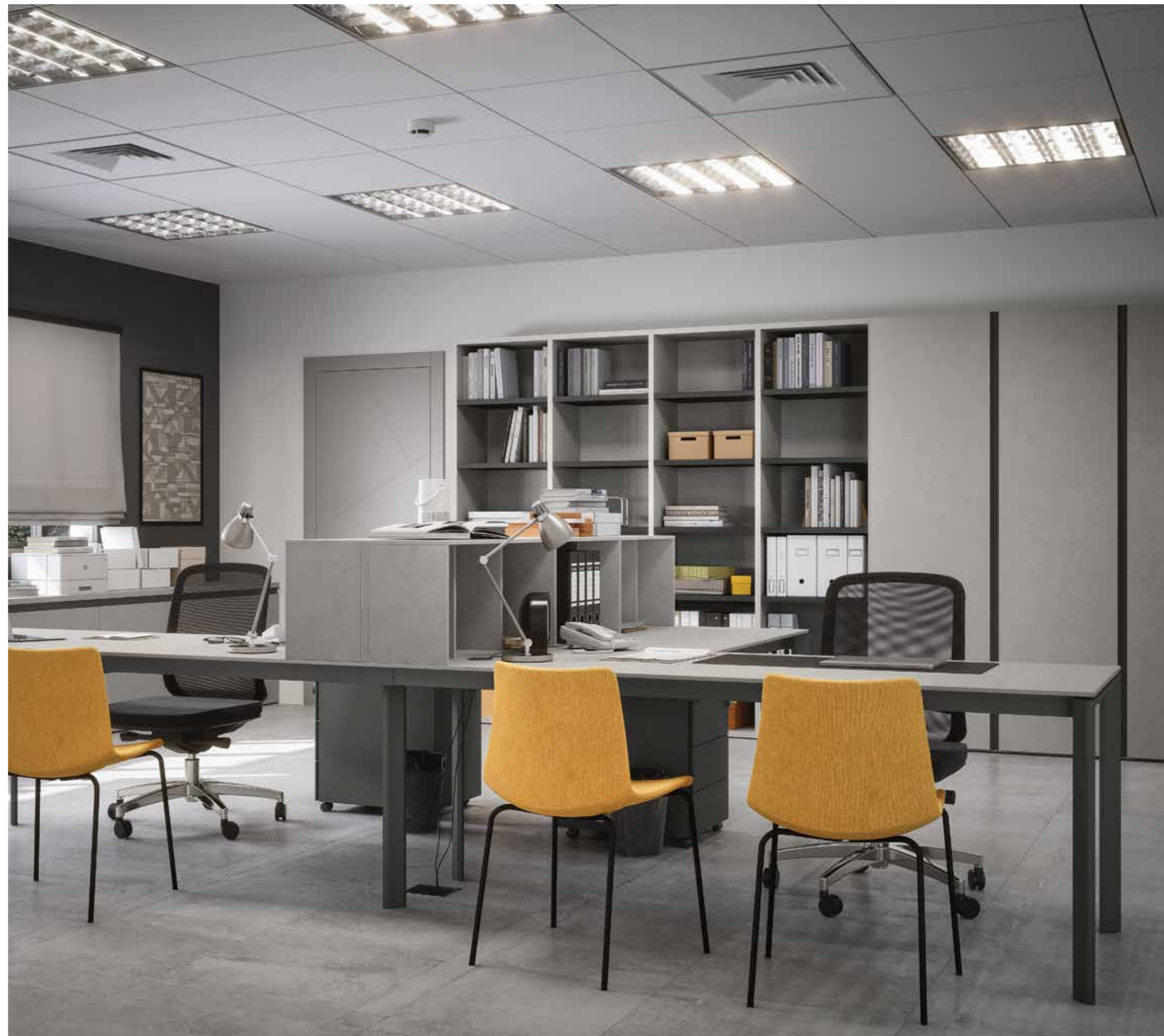



**composizione scrivania**  
desk configuration

L / W 400 cm  
H / H 75 cm  
P / D 200 cm



**elementi / elements**

**scrivanie con piano sp. 1,2 cm**

desks with 1,2 cm-thick top

**divisori casellari / desktop hutches**

**finiture / finishes**

**intonaco / intonaco**

**lavagna / lavagna**

**sedia Assen rete / Assen mesh chair**

**TL32, cromato - pag. 368 / TL32, chrome - page 368**

**sedie Sneek imbottite**

upholstered Sneek chairs

**TF23, basamento R2 nero - pag. 367**

TF23, black R2 base - page 367

**cassettiera in metallo su ruote**

metal drawer unit on castors

**lavagna / lavagna**





**composizione libreria**  
bookcase configuration

L / W 423 cm  
H / H 221,3 cm  
P / D 45,4 cm



**elementi / elements**  
**libreria a terra / floorstanding bookcase**

**finiture / finishes**  
**intonaco / intonaco**  
**lavagna / lavagna**

**composizione parete**  
wall configuration

L / W 630 cm  
H / H 77,2 cm  
P / D 45,8 cm



**elementi / elements**  
**basi a terra**  
floorstanding base units

**finiture / finishes**  
**intonaco / intonaco**  
**lavagna / lavagna**





04a - **04b** - 04c - 04d

**Operativo**  
Workspace

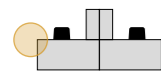

**sedia Sofia rete con braccioli**  
Sofia mesh chair with armrests  
TL35, nero - pag. 368 / TL35, black - page 368  
**cassettiera 3 cassetti con ruote**  
3-drawer unit on castors  
nuvola / nuvola



Ufficio operativo  
Workspace

**composizione scrivania**  
desk configuration

**L / W 400 cm**  
**H / H 75 cm**  
**P / D 413 cm**

**elementi / elements**

**piani scrivania sp. 3 cm con gambe Prisma**

3 cm-thick desk tops with Prisma legs

**penisola sp. 3 cm con gamba Kike**

3 cm-thick desk return with Kike leg

**raccordo Elle sp. 3 cm / 3 cm-thick Elle connector**



**finiture / finishes**

**nuvola / nuvola**

**bianco / bianco**

**composizione parete**  
wall configuration

L / W 483 cm  
H / H 77,9 cm  
P / D 61 cm



**elementi** / elements

**basi a terra** / floorstanding base units  
**libreria a terra** / floorstanding bookcase

**finiture** / finishes

**nuvola** / nuvola  
**noce naturale** / noce naturale



**composizione armadio**  
wardrobe configuration

L / W 405,5 cm  
H / H 239,6 cm  
P / D 61 cm

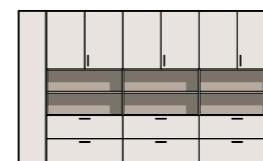

**elementi** / elements

**armadio battente** / hinged door wardrobe  
**terminale libreria** / bookcase end unit

**finiture** / finishes

**nuvola** / nuvola  
**noce naturale** / noce naturale



04a - 04b - **04c** - 04d

# Operativo Workspace

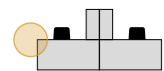

## composizione scrivania desk configuration

L / W 500 cm  
H / H 110 cm  
P / D 405 cm



## elementi / elements

scrivanie con piano sp. 1,2 cm / desks with 1,2 cm-thick top  
penisole con piano sp. 1,2 cm / desk returns with 1,2 cm-thick top  
pannelli divisorio per scrivania / partition screens for desk  
accessori scrivania in metallo / metal desk accessories

## finiture / finishes

lavagna / lavagna  
frassino chiaro / frassino chiaro



sedie York rete senza braccioli / York mesh chairs without armrests  
TL33, cromato - pag. 368 / TL33, chrome - page 368

cassettiere in metallo su ruote / metal drawer units on castors  
lavagna / lavagna





**composizione libreria**  
bookcase configuration

L / W 633 cm  
H / H 221,3 cm  
P / D 45,4 cm



**elementi / elements**  
**libreria a terra / floorstanding bookcase**

**finiture / finishes**  
**lavagna / lavagna**  
**frassino chiaro / frassino chiaro**

**composizione libreria**  
bookcase configuration

L / W 273 cm  
H / H 111,5 cm  
P / D 35,4 cm



**elementi / elements**  
**libreria a terra / floorstanding bookcase**

**finiture / finishes**  
**lavagna / lavagna**





04a - 04b - 04c - **04d**

# Operativo Workspace

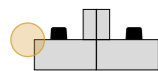

**mensole in metallo**  
metal shelves  
**cemento** / cemento



**composizione parete**  
wall configuration

L / W 270 cm  
H / H 75,9 cm  
P / D 45,8 cm



**elementi** / elements

**basi a terra** / floorstanding base units

**finiture** / finishes

**cemento** / cemento  
**olmo shade** / olmo shade  
**vetro acidato** / etched glass  
**bianco** / bianco

**sedie Laki con braccioli** / Laki chairs with armrests  
TL30 - pag. 368 / TL30 - page 368

**cassettiere in metallo su ruote** / metal drawer units on castors  
**bianco** / bianco

**porta tower PC** / PC tower stand  
**bianco** / bianco

**composizione scrivania**  
desk configuration

L / W 460 cm  
H / H 75 cm  
P / D 460 cm



**elementi** / elements

**piani scrivania sp. 3 cm con gambe Linea**  
3 cm-thick desk tops with Linea legs  
**raccordo Quadro sp. 3 cm**  
3 cm-thick Quadro connector

**finiture** / finishes

**olmo shade** / olmo shade  
**bianco** / bianco



**parete attrezzata**  
wall system

L / W 369 cm  
H / H 257,9 cm  
P / D 45,8 cm

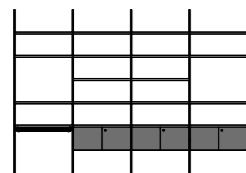

**elementi** / elements  
**sistema Uniko** / Uniko system

**finiture** / finishes  
**olmo shade** / olmo shade  
**cemento** / cemento  
**lavagna** / lavagna





# 05a - 05b - 05c

## Operativo Workspace

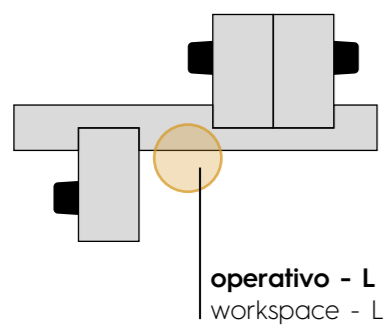

**Organizzare al meglio lo spazio di lavoro in presenza di un ufficio multiplo si può, grazie alla versatilità degli elementi: la vasta gamma di componenti disponibili si adatta al progetto ufficio, organizzando il quotidiano lavorativo in modo intelligente e ottimizzato.**

The versatility of the various items of furniture means it is possible to achieve an optimal workspace setup even when dealing with a shared office: the extensive range of components on offer fits in perfectly with the office design, organizing daily work life in a smart and optimized manner.

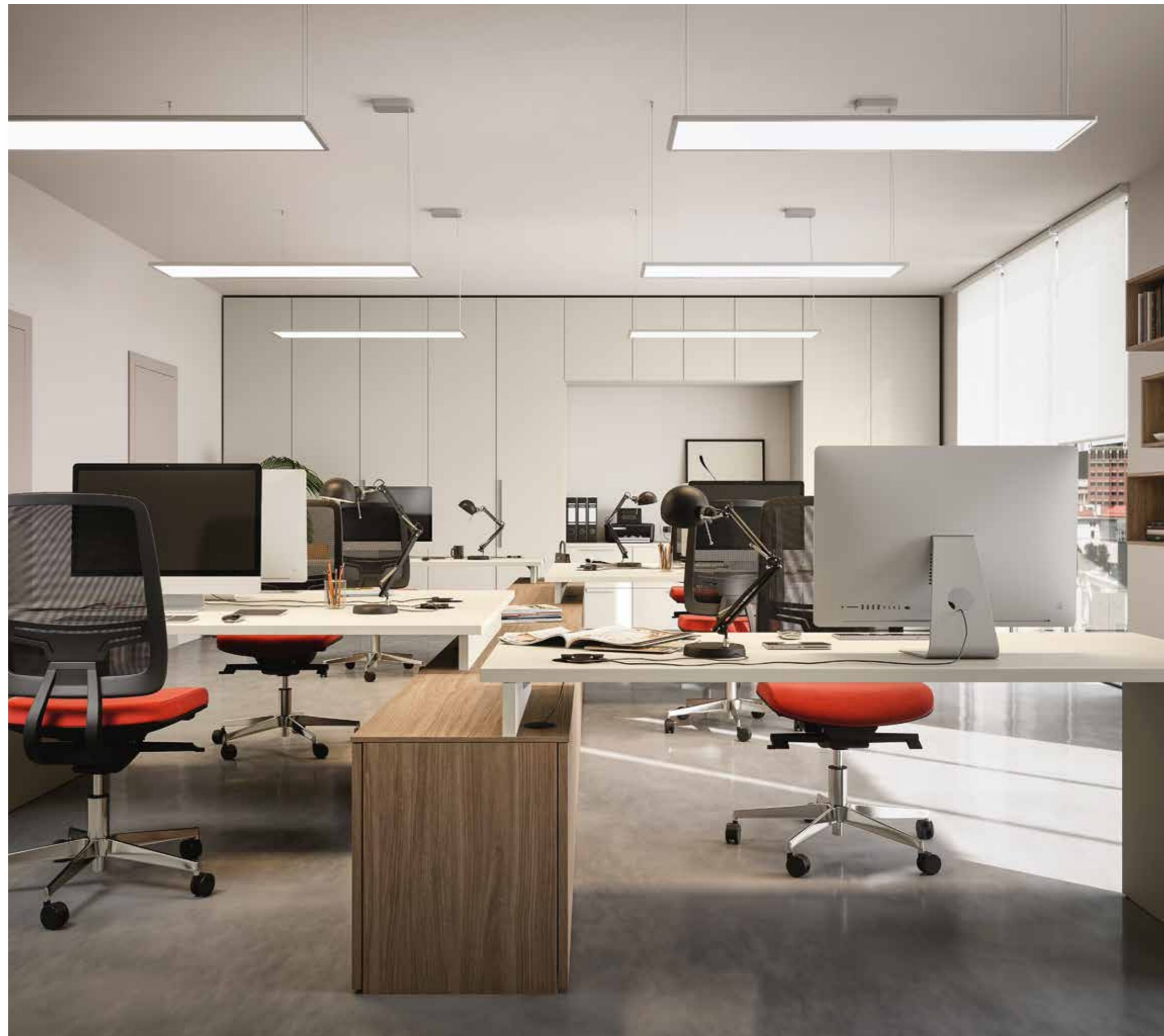



**casellari** / shelving units  
**noce naturale** / noce naturale

**sedie Sofia rete** / Sofia mesh chairs  
**TL34, cromato** - pag. 368 / TL34, chrome - page 368

**composizione armadio**  
 wardrobe configuration

**L / W 632,5 cm**  
**H / H 294,5 cm**  
**P / D 61 cm**

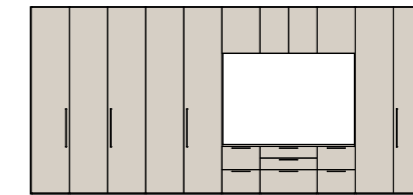

**elementi** / elements

**armadio battente** / hinged door wardrobe  
**armadio ponte** / bridging wardrobe  
**basi armadio** / wardrobe base units

**finiture** / finishes

**canapa** / canapa

**composizione scrivania**  
 desk configuration

**L / W 369 cm**  
**H / H 73 cm**  
**P / D 630 cm**

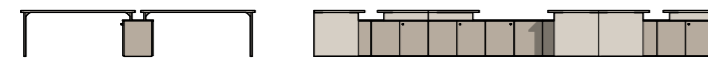

**elementi** / elements

**piani scrivania sp. 3 cm con fianco e in appoggio**  
 3 cm-thick desk tops with side panels and sitting on units  
**basi a terra** / floorstanding base units

**finiture** / finishes

**canapa** / canapa  
**noce naturale** / noce naturale





**composizione armadio**  
wardrobe configuration

L / W 632,5 cm  
H / H 294,5 cm  
P / D 61 cm

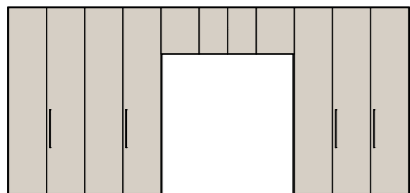

**elementi** / elements

**armadio battente** / hinged door wardrobe  
**armadio ponte** / bridging wardrobe

**finiture** / finishes

**canapa** / canapa



05a - **05b** - 05c  
**Operativo**  
 Workspace

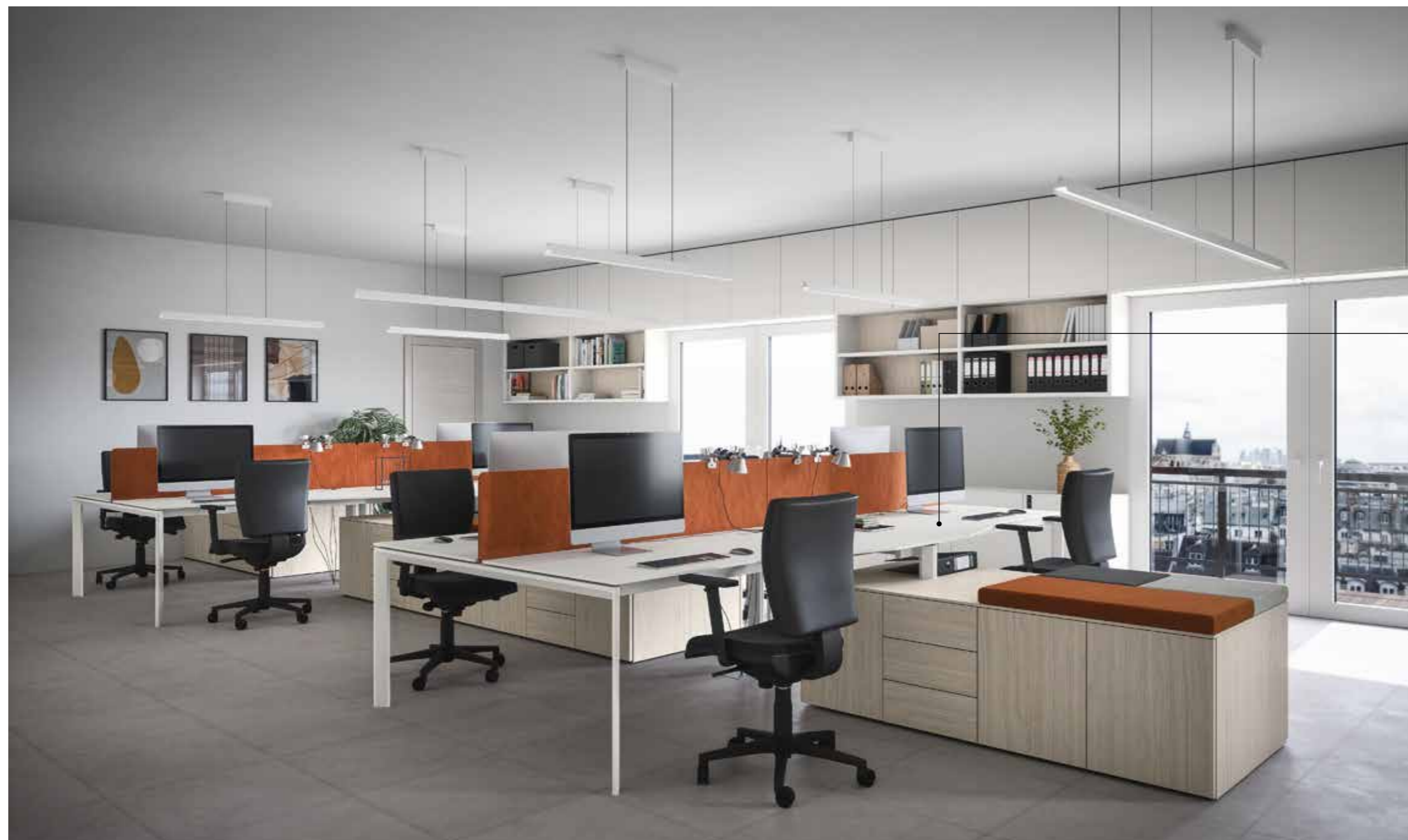

**sedie Laki con braccioli**  
 Laki chairs with armrests  
 TL32 - pag. 368 / TL32 - page 368

**composizione scrivania**  
 desk configuration

L / W 905,5 cm  
 H / H 110,4 cm  
 P / D 360 cm

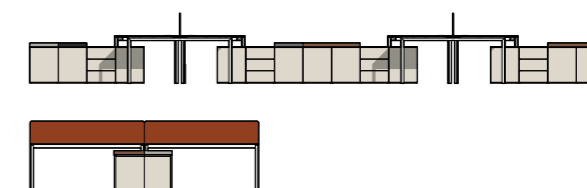

**elementi / elements**

**scrivanie sagomate con piano sp. 1,2 cm**  
 shaped desks with 1,2 cm-thick top

**pannelli divisorio per scrivania /** partition screens for desk

**basi a terra /** floorstanding base units

**sedute imbottite /** padded seats

**finiture / finishes**

**bianco /** bianco

**frassino chiaro /** frassino chiaro

**TF24 /** TF24

**spot T544, T542, T545 /** spot T544, T542, T545

**soff T566 /** soff T566



**parete attrezzata**  
wall system

L / W 1083 cm  
H / H 294,5 cm  
P / D 45,4 cm

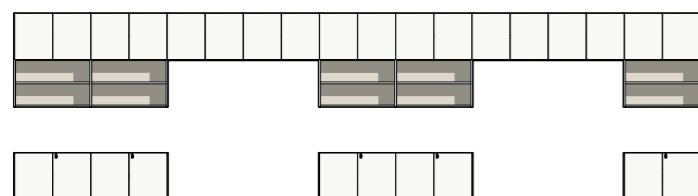

**elementi** / elements

**libreria a terra e sospesa**  
floorstanding and wall-mounted bookcase

**finiture** / finishes

**bianco** / bianco  
**frassino chiaro** / frassino chiaro





05a - 05b - **05c**

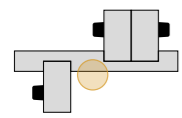

## Operativo Workspace

### composizione scrivania desk configuration

L / W 303 cm  
H / H 115,5 cm  
P / D 426 cm

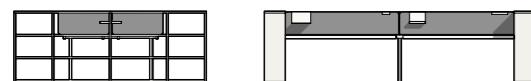

### elementi / elements

scrivanie con piano sp. 1,2 cm / desks with 1,2 cm-thick top  
pannelli divisorio per scrivania / partition screens for desk  
librerie a terra / floorstanding bookcases  
accessori scrivania in metallo / metal desk accessories

### finiture / finishes

olmo shade / olmo shade  
intonaco / intonaco  
bianco / bianco  
TF21 / TF21



sedie York rete con braccioli / York mesh chairs with armrests  
TL36, nero - pag. 368 / TL36, black - page 368







**composizione libreria**  
bookcase configuration

L / W 633 cm  
H / H 257,9 cm  
P / D 35,4 cm

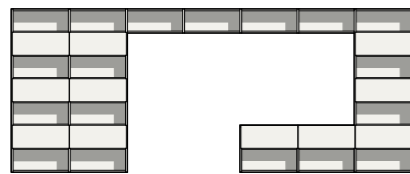

**elementi / elements**

**libreria a terra e sospesa** / floorstanding and wall-mounted bookcase

**finiture / finishes**

**olmo shade** / olmo shade

**composizione libreria**  
bookcase configuration

L / W 633 cm  
H / H 257,9 cm  
P / D 35,4 cm

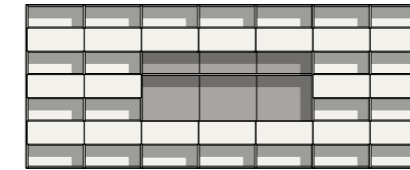

**elementi / elements**

**libreria a terra e sospesa**

floorstanding and wall-mounted bookcase

**boiserie Arnad** / Arnad wall panelling

**mensola sp. 3 cm** / 3 cm-thick shelf

**finiture / finishes**

**olmo shade** / olmo shade

**intonaco** / intonaco



# Comfort lavorativo e layout ottimizzato

Worker comfort and optimized layout

**Moderno e funzionale, l'ufficio open space è il protagonista del nuovo modo di concepire il lavoro: dinamico e collaborativo.**

**Razionalità e comodità diventano il binomio perfetto per un progetto dove organizzazione e rispetto della privacy personale trovano il giusto spazio.**

Modern and functional, the open-plan office plays a starring role in the new approach to work: dynamic and collaborative.

Rationality and comfort become the perfect combo for a design that strikes just the right balance between organization and respect for personal privacy.

## open space multifunzionali / multifunctional open-plan layout

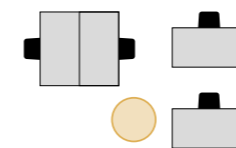

06a - pag. 96



06b - pag. 104



06c - pag. 112



# 06a - 06b - 06c

## Open space

### Open-plan layout

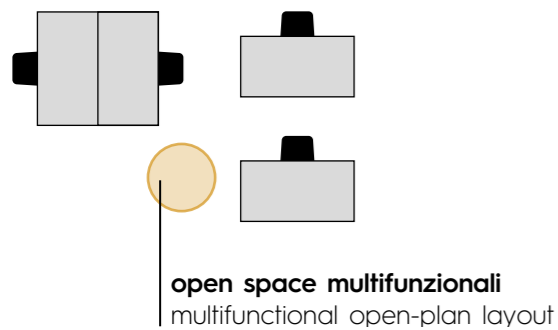

**Dinamico e flessibile, l'open space multifunzionale è la giusta formula per assicurare sinergia e rendere lo spazio di lavoro operativo. La modularità degli elementi assicura un progetto ufficio flessibile ed efficiente, per un ambiente confortevole e professionale.**  
Dynamic and flexible, the multifunctional open-plan layout is the ideal formula for promoting synergy and making for a practical and productive workspace. The furniture's modular design ensures the office layout is flexible and efficient, resulting in a comfortable, professional environment.





**composizione libreria**  
bookcase configuration

L / W 363 cm  
H / H 148,1 cm  
P / D 45,4 cm



**elementi** / elements

**libreria a terra** / floorstanding bookcase

**finiture** / finishes

**nuvola** / nuvola  
**vetro fumé** / smoked glass  
**bianco** / bianco

**composizione scrivania**  
desk configuration

L / W 360 cm  
H / H 77 cm  
P / D 160 cm

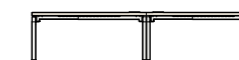

**elementi** / elements

**piani scrivania sp. 5 cm con gambe Prisma**  
5 cm-thick desk tops with Prisma legs

**finiture** / finishes

**frassino chiaro** / frassino chiaro  
**bianco** / bianco

**sedie York** / York chairs  
TL32, nero - pag. 368 / TL32, black - page 368

**cassettiere 3 cassetti con ruote**  
3-drawer unit on castors  
**nuvola** / nuvola





**composizione libreria**  
bookcase configuration

L / W 393 cm  
H / H 294,5 cm  
P / D 33 cm

L / W 546 cm  
H / H 294,5 cm  
P / D 33 cm



**elementi / elements**

**libreria a terra /** floorstanding bookcase

**finiture / finishes**

**nuvola /** nuvola

**divano Madrid /** Madrid sofa  
cross T508, fettuccia a contrasto CC15 - pag. 372  
cross T508, CC15 contrasting piping - page 372







**composizione parete**  
wall configuration

L / W 240 cm  
H / H 76,1 cm  
P / D 45,8 cm



**elementi / elements**

**basi a terra / floorstanding base units**

**finiture / finishes**

**cemento / cemento**

**vetro fumé / smoked glass**

**lavagna / lavagna**

**sgabelli Sneek / Sneek stools**

J10, nero - pag. 370 / J10, black - page 370

**piano sospeso con alzata sp. 5 cm**

5 cm-thick wall-mounted top with upstand

frassino chiaro - pag. 356 / frassino chiaro - page 356

**sedie Cannes / Cannes chairs**  
TL31 - pag. 369 / TL31 - page 369

**scrivania con piano sp. 1,2 cm**  
desk with 1,2 cm-thick top  
**lavagna, intonaco - pag. 358**  
lavagna, intonaco - page 358





06a - **06b** - 06c

 **Open space**  
 Open-plan layout

sedie Basilea / Basilea chairs  
TL31, nero - pag. 369  
TL31, black - page 369



**composizione scrivania**  
desk configuration

L / W 403 cm  
H / H 110,4 cm  
P / D 160 cm



**elementi** / elements

**scrivanie con piano sp. 1,2 cm** / desks with 1,2 cm-thick top  
**basi con portaoggetti, schedario estraibile ed alzata**  
base units with tray, filing drawer and hutch

**finiture** / finishes

**calce** / calce  
**lavagna** / lavagna



**composizione armadio**  
wardrobe configuration

L / W 522,8 cm  
H / H 239,6 cm  
P / D 65,4 cm

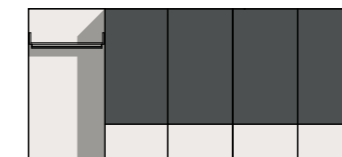

**elementi** / elements

**armadio scorrevole** / sliding door wardrobe  
**boiserie Cover** / Cover wall panelling  
**componenti Cover** / Cover components

**finiture** / finishes

**calce** / calce  
**lavagna** / lavagna







**libreria Oasi** / Oasi bookcase  
**lavagna, calce** / lavagna, calce

**divano Madrid** / Madrid sofa  
**thick T523, fettuccia a contrasto CC10** - pag. 372  
 thick T523, CC10 contrasting piping - page 372





**composizione parete**  
wall configuration

L / W 240 cm  
H / H 38,8 cm  
P / D 45,8 cm



**elementi** / elements

**basi sospese** / wall-mounted base units

**finiture** / finishes

**calce** / calce

**lavagna** / lavagna

**sgabelli Helsinky** / Helsinky stools

TL31 - pag. 370 / TL31 - page 370

**scrivanie dinamiche con piano sp. 3 cm** / sit-stand desks with 3 cm-thick top

lavagna - pag. 354 / lavagna - page 354





06a - 06b - **06c**

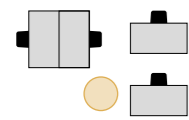

## Open space Open-plan layout

### composizione scrivania desk configuration

L / W 403 cm  
H / H 110 cm  
P / D 244 cm



### elementi / elements

scrivanie con piano sp. 1,2 cm / desks with 1,2 cm-thick top  
fianchi scrivania sp. 3 cm / 3 cm-thick desk side panels  
librerie a terra / floorstanding bookcases  
pannelli divisorio per scrivania / partition screens for desk

### finiture / finishes

bianco / bianco  
rovere cotto / rovere cotto  
TF21 / TF21



sedie Assen rete con braccioli / Assen mesh chairs with armrests  
TL35, nero - pag. 368 / TL35, black - page 368

porta borse-ombrello / bag-umbrella rack  
bianco / bianco





**composizione libreria**  
bookcase configuration

L / W 363 cm  
H / H 203 cm  
P / D 45,4 cm



**elementi / elements**  
**libreria con gambe metalliche**  
bookcase with metal legs

**finiture / finishes**

**bianco / bianco**  
**vetro trasparente / transparent glass**

**composizione parete**  
wall configuration

L / W 335,2 cm  
H / H 47,3 cm  
P / D 45,8 cm

L / W 275,4 cm  
H / H 47,3 cm  
P / D 45,8 cm

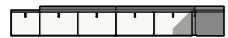

**elementi / elements**  
**basi a terra / floorstanding base units**  
**seduta imbottita / padded seat**

**finiture / finishes**

**bianco / bianco**  
**spot T544 / spot T544**



**casellari Zip12**  
Zip12 shelving units  
**bianco / bianco**

**sedie Sneek lounge**  
Sneek lounge chairs  
**spot T544, bianco - pag. 371**  
spot T544, white - page 371

**tavolino Orig / Orig side table**  
**rovere cotto, bianco - pag. 351**  
rovere cotto, bianco - page 351







**composizione libreria**  
bookcase configuration

L / W 363 cm  
H / H 221,3 cm  
P / D 45,4 cm



**elementi / elements**

**libreria ponte e a terra**  
bridging and floorstanding bookcase

**finiture / finishes**

**bianco** / bianco  
**rovere cotto** / rovere cotto

**sedie Nice** / Nice chairs  
TL35 - pag. 369 / TL35 - page 369

**scrivania con piano in vetro sp. 1,2 cm**  
desk with 1,2 cm-thick glass top  
**vetro bianco, bianco** - pag. 358  
white glass, bianco - page 358

# Progettare un'area d'attesa funzionale ma confortevole

Designing a functional yet  
comfortable waiting area

**Gli spazi comuni all'interno di un'organizzazione si distinguono per la ricerca di comfort e funzionalità. Sono zone riservate alla convivialità, ma anche spazi operativi fondamentali, la cui ottimizzazione risulta determinante. Un importante biglietto da visita per l'azienda.**

A key factor for common areas within an organization is building comfort and functionality into the design. These are areas that need to have a friendly feel, but are also essential workspaces whose success relies on an optimal layout. An important calling card for the business.

## sala d'attesa / waiting room

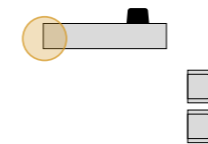

07a - pag. 120



07b - pag. 126



07c - pag. 130

## sala riunioni / meeting room

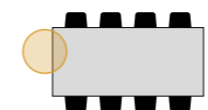

08a - pag. 134



08b - pag. 138



08c - pag. 142

## area break / break room

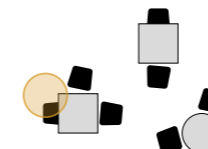

09a - pag. 146



09b - pag. 150



09c - pag. 154



# 07a - 07b - 07c

## Spazi comuni

### Common areas

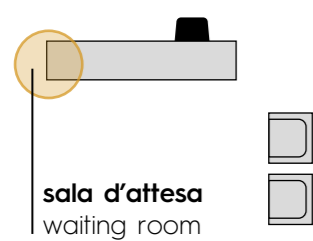

**Un layout semplice e ottimizzato dove la funzionalità strizza l'occhio alla ricerca di soluzioni dall'alto contenuto estetico e qualitativo. Ambienti condivisi e versatili, pensati per accogliere il quotidiano lavorativo e assicurare il massimo risultato in termini di utilizzo degli spazi.**

A simple, optimized layout where functionality gives a nod to the focus on solutions with superior aesthetics and quality. Shared, versatile spaces, designed to accommodate daily work life while also delivering in terms of optimal use of space.





**bancone reception**  
reception desk

L / W 406 cm  
H / H 110,7 cm  
P / D 82 cm

L / W 400 cm  
H / H 75 cm  
P / D 80 cm



**elementi / elements**  
**scrivanie con piano sp. 1,2 cm**  
desks with 1,2 cm-thick top  
**bancone con fianchi sp. 3 cm**  
reception desk with 3 cm-thick side panels

**finiture / finishes**  
**cashmere / cashmere**  
**lavagna / lavagna**

**composizione libreria**  
bookcase configuration

L / W 273 cm  
H / H 74,9 cm  
P / D 45,4 cm

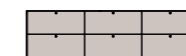

**elementi / elements**  
**libreria a terra**  
floorstanding bookcase

**finiture / finishes**  
**cashmere / cashmere**

**sedie Basilea con braccioli**  
Basilea chairs with armrests  
**TL36, nero - pag. 369**  
TL36, black - page 369







**composizione libreria**  
bookcase configuration

L / W 453 cm  
H / H 294,5 cm  
P / D 35,4 cm



**elementi** / elements

**libreria a terra** / floorstanding bookcase

**finiture** / finishes

**cashmere** / cashmere

**sedie Sneek lounge** / Sneek lounge chairs

spot T553, nero - pag. 371

spot T553, black - page 371

**tavolini Anversa** / Anversa occasional tables

sabbia, nero - pag. 365 / sabbia, nero - page 365

**divano Madrid** / Madrid sofa

spot T553, fettuccia a contrasto CC12 - pag. 372

spot T553, CC12 contrasting piping - page 372



07a - **07b** - 07c

 **Spazi comuni**  
 Common areas



**mensole ad L** / L-shaped shelves  
**olmo shade** / olmo shade



**bancone reception**  
reception desk

L / W 358 cm  
H / H 110,7 cm  
P / D 238 cm

L / W 200 cm  
H / H 75 cm  
P / D 320 cm



**elementi** / elements

**scrivania con piano sp. 1,2 cm** / desk with 1,2 cm-thick top  
**penisola con piano sp. 1,2 cm** / desk return with 1,2 cm-thick top  
**bancone reception con fianchi sp. 3 cm**  
reception desk with 3 cm-thick side panels  
**librerie a terra** / floorstanding bookcases

**finiture** / finishes

**bianco** / bianco  
**olmo shade** / olmo shade  
**intonaco** / intonaco

**casellari con crociera** / shelving units with pigeon hole  
**intonaco** - pag. 304 / intonaco - page 304



**sgabelli Sneek** / Sneek stools  
J00, bianco - pag. 370 / J00, white - page 370

**piano sospeso con alzata sp. 5 cm**  
5 cm-thick wall-mounted top with upstand  
olmo shade - pag. 356 / olmo shade - page 356

**composizione sala d'attesa**  
waiting room configuration

L / W 300 cm  
H / H 222,5 cm  
P / D 43 cm

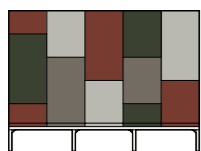

**elementi** / elements

**boiserie Arnad** / Arnad wall panelling  
**pannello sp. 5 cm** / 5 cm-thick panel  
**fianchi scrivania sp. 5 cm** / 5 cm-thick desk side panels  
**seduta imbottita** / padded seat

**finiture** / finishes

**olmo shade** / olmo shade  
cross T506, T508, T513, T515 / cross T506, T508, T513, T515

**sedie Sneek lounge** / Sneek lounge chairs  
smooth T171, bianco - pag. 371 / smooth T171, white - page 371

**tavolini Anversa** / Anversa occasional tables  
intonaco, bianco - pag. 365 / intonaco, bianco - page 365





07a - 07b - 07c

# Spazi comuni Common areas

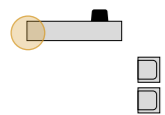

**sedie Laki con braccioli** / Laki chairs with armrests  
TL32 - pag. 368 / TL32 - page 368

**composizione parete**  
wall configuration

L / W 360 cm  
H / H 76,1 cm  
P / D 45,8 cm



**elementi** / elements  
**basi a terra** / floorstanding base units

**finiture** / finishes  
**nuvola** / nuvola



**composizione reception**  
reception area configuration

L / W 392 cm  
H / H 111,5 cm  
P / D 82 cm

L / W 140 cm  
H / H 75 cm  
P / D 80 cm



**elementi** / elements

**banconi reception con fianchi sp. 3 cm**  
reception desks with 3 cm-thick side panels  
**piano scrivania sp. 3 cm** / 3 cm-thick desk top  
**scrivanie con piano sp. 1,2 cm** / desks with 1,2 cm-thick top

**finiture** / finishes  
**noce naturale** / noce naturale  
**nuvola** / nuvola  
**bianco** / bianco



Spazi comuni  
Common areas





**parete attrezzata**  
wall system

L / W 403,8 cm  
H / H 239,6 cm  
P / D 37,7 cm

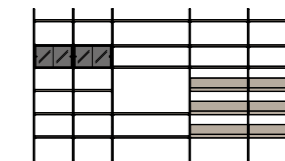

**elementi** / elements

**sistema Uniko** / Uniko system

**finiture** / finishes

**noce naturale** / noce naturale

**lavagna** / lavagna

**vetro fumé** / smoked glass

**casellari** / shelving units

**nuvola** - pag. 304 / nuvola - page 304

**divano Madrid** / Madrid sofa

**thick T522, fettuccia a contrasto CC12** - pag. 372  
thick T522, CC12 contrasting piping - page 372

**tavolini Orig** / Orig side tables

**nuvola, noce naturale** - pag. 351

nuvola, noce naturale - page 351



# 08a - 08b - 08c

## Spazi comuni Common areas

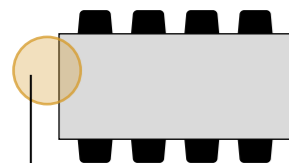

sala riunioni  
meeting room

**Il layout compositivo privilegia la condivisione e la praticità: gli spazi comuni diventano luoghi di incontro e di confronto, ambienti operativi dove lo studio dell'arredo si basa soprattutto sul quotidiano lavorativo delle persone. Elementi funzionali per un progetto all'insegna del design ergonomico.**

Shared spaces and practicality inform the layout: common areas are turned into places where people can come together and exchange ideas; workspaces where the furniture is designed, above all, to accommodate the occupants' everyday tasks. Functional elements for a design that is all about ergonomics.





**composizione armadio**  
wardrobe configuration

L / W 420,4 cm  
H / H 239,6 cm  
P / D 35,8 cm

L / W 600 cm  
H / H 239,6 cm  
P / D 61 cm

L / W 420,4 cm  
H / H 239,6 cm  
P / D 2,7 cm

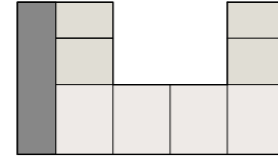
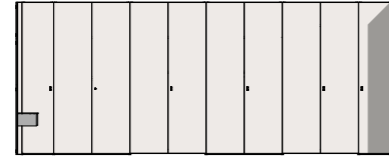
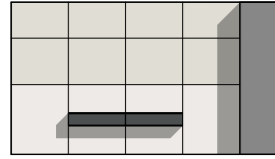

**elementi / elements**

**boiserie Arnad** / Arnad wall panelling  
**basi sospese** / wall-mounted base units  
**armadio battente** / hinged door wardrobe

**finiture / finishes**

**calce** / calce  
**lavagna** / lavagna  
**nuvola** / nuvola  
**spot T541** / spot T541



**sedie Sneek** / Sneek chairs  
J10, basamento R2 nero - pag. 366  
J10, black R2 base - page 366



**tavolo richiudibile** / folding table  
lavagna - pag. 364 / lavagna - page 364



08a - **08b** - 08c

 **Spazi comuni**  
Common areas

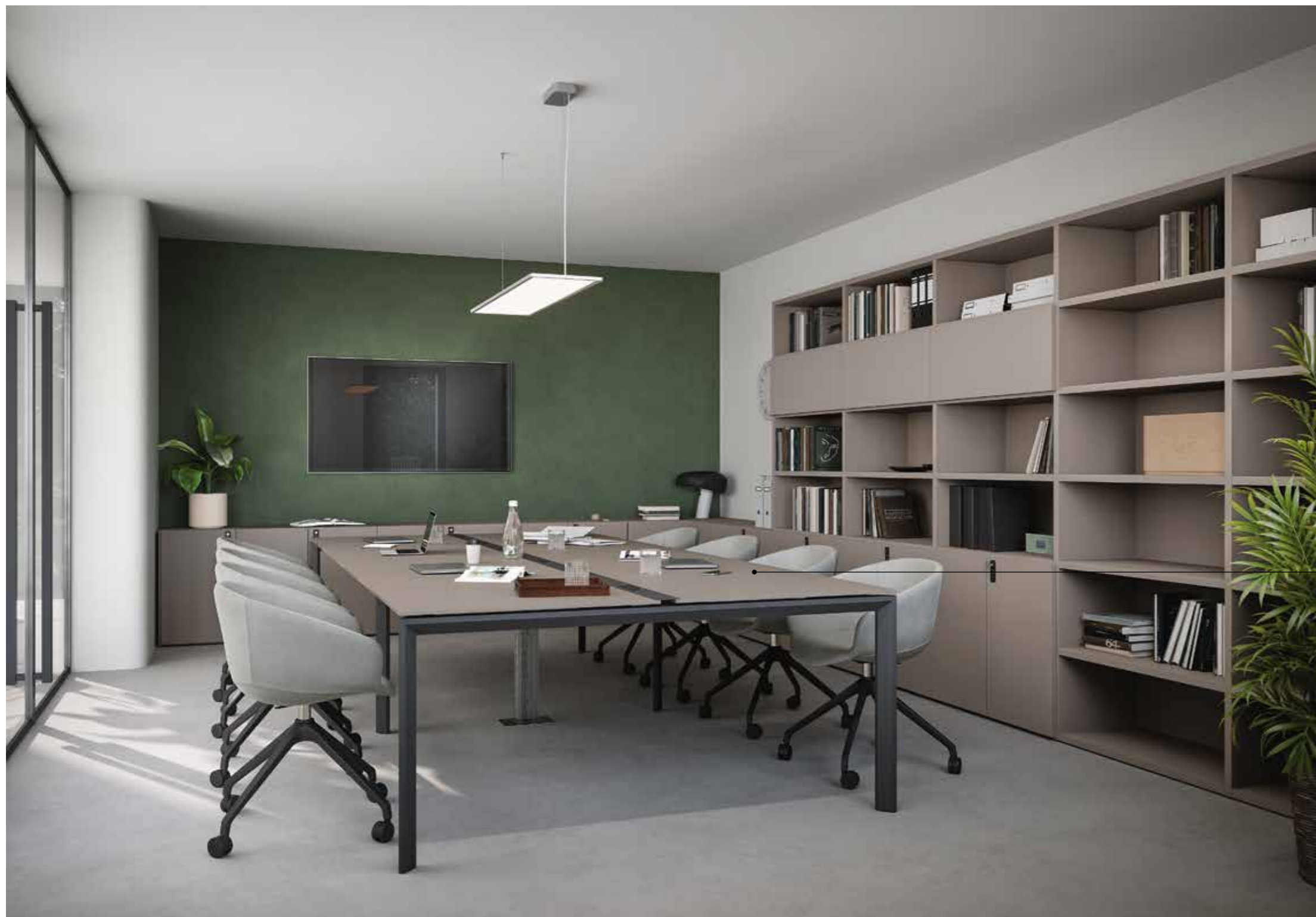

**sedie Cannes** / Cannes chairs  
TL30 - pag. 369 / TL30 - page 369

**composizione sala riunioni**  
meeting room configuration

L / W 360 cm  
H / H 75 cm  
P / D 165 cm



**elementi** / elements  
**scrivanie doppie con piano sp. 1,2 cm** / double desks with 1,2 cm-thick top

**finiture** / finishes  
**basalto** / basalto  
**lavagna** / lavagna





**composizione libreria**  
bookcase configuration

L / W 410 cm  
H / H 74,9 cm  
P / D 45,4 cm

L / W 590 cm  
H / H 221,3 cm  
P / D 45,4 cm

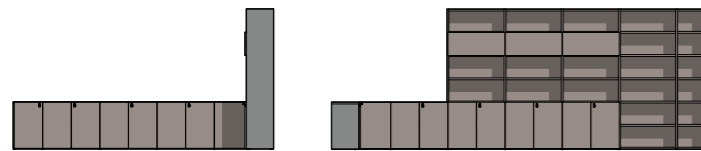

**elementi** / elements

**libreria a terra** / floorstanding bookcase

**finiture** / finishes

**basalto** / basalto

08a - 08b - **08c**

## Spazi comuni Common areas

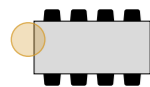

**sedie Nice** / Nice chairs  
TL31 - pag. 369 / TL31 - page 369

**composizione parete**  
wall configuration

L / W 360 cm  
H / H 171 cm  
P / D 35,8 cm

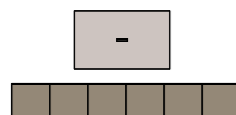

**elementi** / elements

**basi sospese** / wall-mounted base units  
**pannello porta TV** / TV mounting panel

**finiture** / finishes

**cashmere** / cashmere  
**rovere cotto** / rovere cotto



**composizione sala riunioni**  
meeting room configuration

L / W 400 cm  
H / H 77 cm  
P / D 120 cm



**finiture** / finishes

**lavagna** / lavagna  
**rovere cotto** / rovere cotto

**elementi** / elements

**piani scrivania sagomati sp. 3 cm con gambe Linea**  
3 cm-thick shaped desk tops with Linea legs

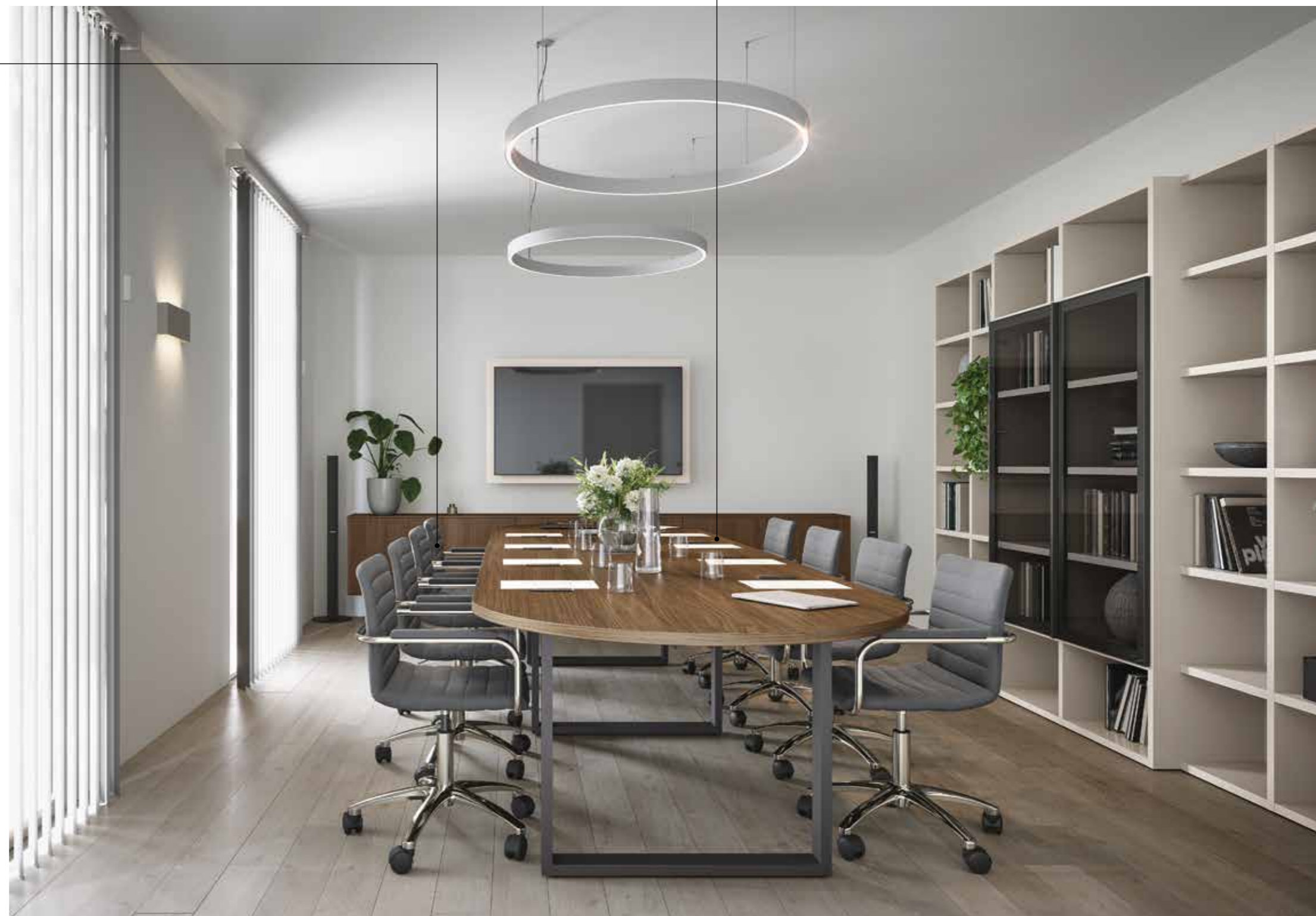





**composizione libreria**  
bookcase configuration

L / W 303 cm  
H / H 221,3 cm  
P / D 35,4 - 45,4 cm



**elementi** / elements

**libreria a terra** / floorstanding bookcase

**finiture** / finishes

**cashmere** / cashmere

**vetro fumé** / smoked glass

**lavagna** / lavagna



# 09a - 09b - 09c

## Spazi comuni

### Common areas

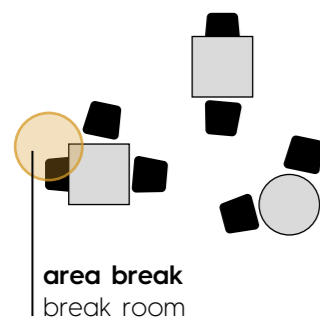

**Accoglienza e operatività diventano i punti di forza nella progettazione degli spazi comuni. Ambienti dove convivialità e privacy trovano spazio all'interno del progetto di interior. Aree caratterizzate dal comfort e dalla praticità degli elementi compositivi.**  
A welcoming feel and effective functionality become key factors in the design of common areas. An interior design that accommodates the need for both privacy and a place to get together. Areas characterized by the comfort and practicality of their component parts.







**parete attrezzata**  
wall system

L / W 360 cm  
H / H 221,8 cm  
P / D 61 cm

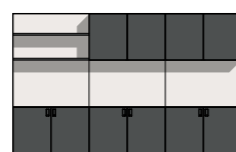

**elementi / elements**

**boiserie Arnad** / Arnad wall panelling  
**mensole sp. 3 cm** / 3 cm-thick shelves  
**pensili** / wall units  
**basi sospese** / wall-mounted base units

**finiture / finishes**

**lavagna** / lavagna  
**calce** / calce

**composizione libreria**  
bookcase configuration

L / W 648 cm  
H / H 294,5 cm  
P / D 33 cm

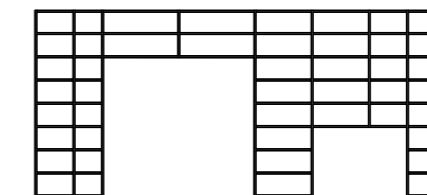

**elementi / elements**

**libreria a terra e sospesa** / floorstanding and wall-mounted bookcase

**finiture / finishes**

**lavagna** / lavagna

**sedie Giant** / Giant chairs  
J21 - pag. 366 / J21 - page 366

**tavolini Anversa** / Anversa occasional tables  
rovere cotto, nero - pag. 365 / rovere cotto, nero - page 365



09a - **09b** - 09c

 **Spazi comuni**  
Common areas



**sgabelli Harlem** / Harlem stools  
TL32 - pag. 370 / TL32 - page 370

**composizione area break**  
break room configuration

L / W 180 cm  
H / H 101 cm  
P / D 70 cm

**elementi** / elements



**piani scrivania sp. 5 cm** / 5 cm-thick desk tops  
**fianchi sp. 5 cm** / 5 cm-thick side panels

**finiture** / finishes

**noce naturale** / noce naturale

Spazi comuni  
Common areas



**composizione libreria**  
bookcase configuration

L / W 303 cm  
H / H 293,8 cm  
P / D 33 cm

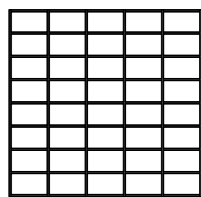

**elementi / elements**  
**libreria a terra / floorstanding bookcase**

**finiture / finishes**  
**lavagna / lavagna**



**parete attrezzata**  
wall system

L / W 460,8 cm  
H / H 221,3 cm  
P / D 45,8 cm

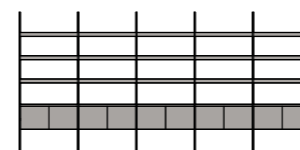

**elementi / elements**  
**sistema Uniko / Uniko system**

**finiture / finishes**  
**intonaco / intonaco**  
**lavagna / lavagna**

**consolle appendiabiti**  
coat rack booths  
**intonaco / intonaco**

09a - 09b - **09c**

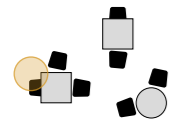

## Spazi comuni Common areas

**sgabelli Sneek** / Sneek stools  
J10, nero - pag. 370 / J10, black - page 370

**composizione area break**  
break room configuration

L / W 450 cm  
H / H 36,6 cm  
P / D 45,8 cm



**elementi** / elements

**piano sospeso con alzata sp. 5 cm**  
5 cm-thick wall-mounted top with upstand

**finiture** / finishes

**frassino chiaro** / frassino chiaro







**composizione area break**  
break room configuration

L / W 182,5 cm  
H / H 239,7 cm  
P / D 61 cm

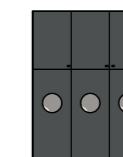

**elementi** / elements

**armadio battente** / hinged door wardrobe  
**elementi sovrapponibili** / stackable units

**finiture** / finishes

**lavagna** / lavagna

**divano Madrid** / Madrid sofa  
**smooth T167** - pag. 372  
smooth T167 - page 372

**tavolino Anversa** / Anversa occasional table  
**frassino chiaro, nero** - pag. 365  
frassino chiaro, nero - page 365

**ricezione**  
accommodation



# In albergo, ritrovare lo stesso benessere abitativo della propria casa

A hotel with all the comforts of home

**Arredare, ottimizzando lo spazio, senza tralasciare lo stile.**

**La modularità degli elementi veste ogni stanza in base alle dimensioni, rendendo l'ambiente funzionale e piacevole a livello estetico. La scelta di finiture e colori concorre a personalizzare il progetto.**

Furnishing interiors, optimizing space without skimping on style.

The furniture's modular design means each room gets a size-appropriate fitout, resulting in a functional and aesthetically pleasing interior. The choice of finishes and colours helps add a custom touch to the scheme.

## camera hotel matrimoniale / double hotel room

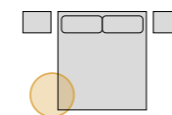

10a - pag. 162



10b - pag. 168



10c - pag. 172

## camera hotel multipla / twin share hotel room

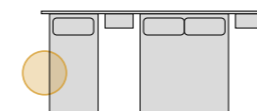

11a - pag. 176



11b - pag. 182



11c - pag. 188

# 10a - 10b - 10c

## Camera hotel

### Hotel room

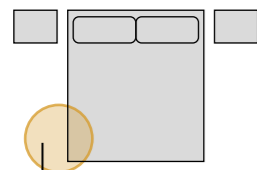

camera hotel matrimoniale  
double hotel room

**Per chi viaggia è importante che la camera d'albergo abbia tutte le caratteristiche necessarie per rendere l'ambiente confortevole. Elementi contenitivi a parete permettono di mantenere l'ordine e di riporre valigie e altri oggetti con comodità, mentre gli altri complementi esaltano la sensazione di benessere.**

For travellers, it is important that a hotel room have all the features required to ensure a comfortable environment. Wall-mounted storage units help keep the room tidy and provide a handy place to stow luggage and other items, while other occasional pieces add to the feel-good vibe.







**composizione parete**  
wall configuration

L / W 285 cm  
H / H 73 cm  
P / D 60,6 cm

**elementi / elements**

scrivania con vano per frigo / desk with mini-bar cabinet  
portavaligie con schiena / luggage shelf with back panel  
seduta imbottita / padded seat

**finiture / finishes**

sabbia / sabbia  
cross T502 / cross T502

**composizione armadio**  
wardrobe configuration

L / W 295 cm  
H / H 239,6 cm  
P / D 61 cm



**elementi / elements**

armadio battente / hinged door wardrobe  
terminale trapezio / trapezium end unit  
cabina cremagliera / slotted rail walk-in closet  
pedana h 3 cm / plinth H 3 cm

**finiture / finishes**

noce naturale / noce naturale  
specchio chiaro / light mirror



**sedia Sneek imbottita**  
upholstered Sneek chair  
smooth T171, basamento R2 nero - pag. 367  
smooth T171, black R2 base - page 367





**letto Isla R18Z dritto** / straight R18Z Isla bed  
**smooth T152, sabbia** - pag. 338  
smooth T152, sabbia - page 338

**comodino Oslo** / Oslo bedside table  
**sabbia** - pag. 350 / sabbia - page 350



10a - **10b** - 10c

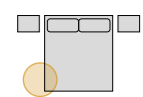

## Camera hotel

Hotel room

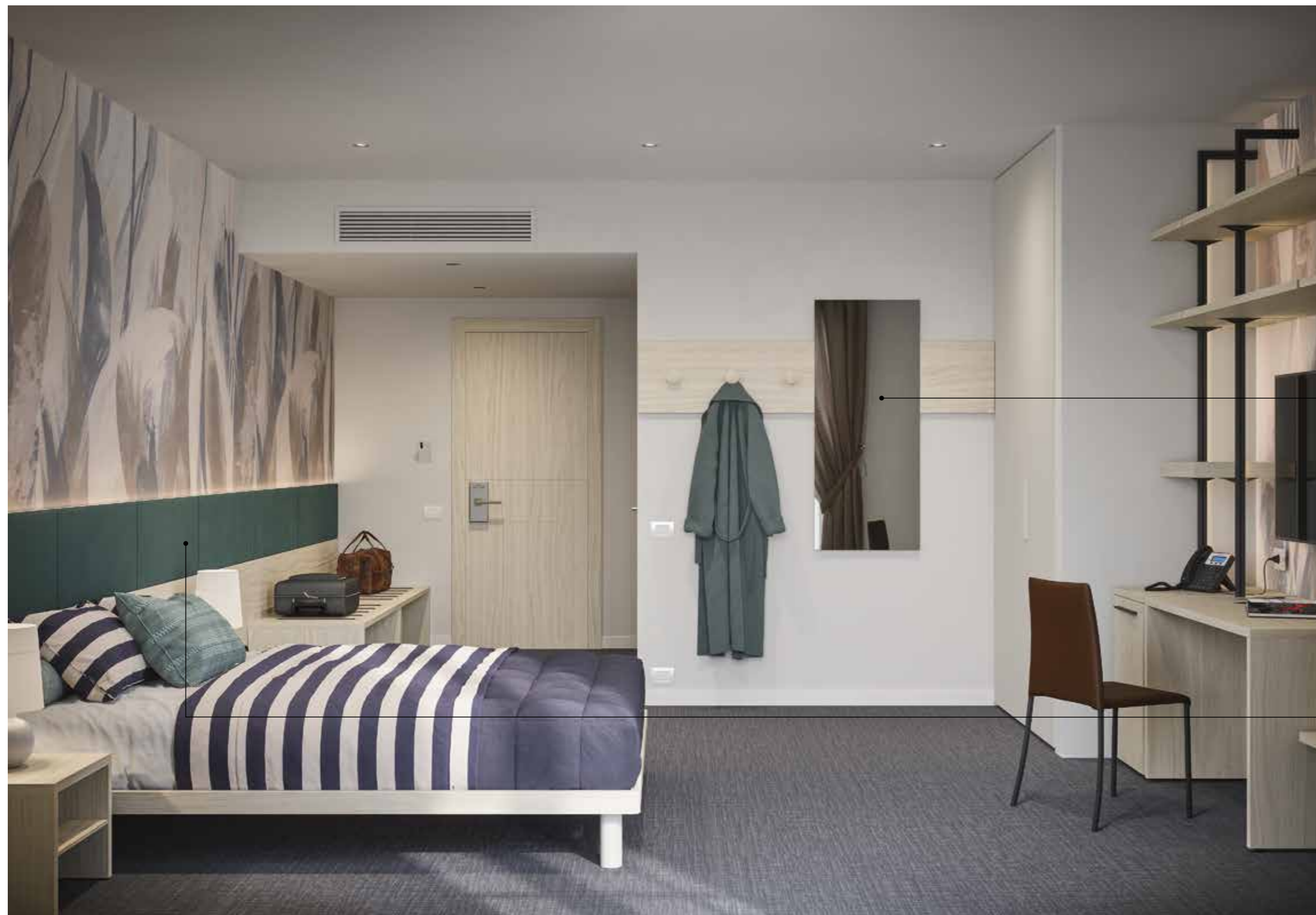

**Turca R70 stondato** / rounded R70 platform bed  
frassino chiaro, nuvola - pag. 333  
frassino chiaro, nuvola - page 333

**comodino con ripiano** / bedside table with shelf  
frassino chiaro / frassino chiaro

**composizione appendiabiti**  
coat hook configuration

L / W 182 cm  
H / H 128 cm  
P / D 2,7 cm

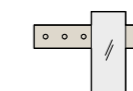

**elementi / elements**

**boiserie Arnad** / Arnad wall panelling  
**pomoli appendiabiti** / clothes hanger knobs  
**specchio** / mirror

**finiture / finishes**

**frassino chiaro** / frassino chiaro  
**specchio chiaro** / light mirror

**composizione parete**  
wall configuration

L / W 690 cm  
H / H 109,8 cm  
P / D 63,3 cm

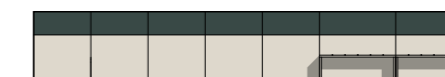

**elementi / elements**

**boiserie Arnad**  
Arnad wall panelling  
**portavaligie** / luggage shelf

**finiture / finishes**

**frassino chiaro** / frassino chiaro  
**soff T567** / soff T567



**parete attrezzata**

wall system

|                |                |                |
|----------------|----------------|----------------|
| L / W 134,3 cm | L / W 133 cm   | L / W 292,2 cm |
| H / H 269 cm   | H / H 221,3 cm | H / H 257,9 cm |
| P / D 11,2 cm  | P / D 43 cm    | P / D 61 cm    |

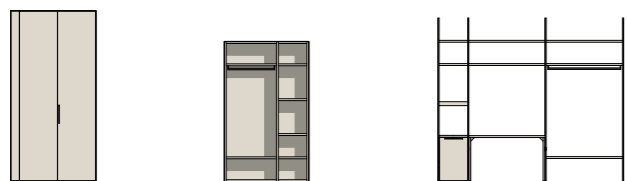

**elementi / elements**

**chiusura pieghevole / folding closing system**

**cabina a spalla**

walk-in closet system with load-bearing side panels

**sistema Uniko / Uniko system**

**scrivitoio sp. 3 cm con fianchi / 3 cm-thick desk top with side panels**

**base con vano per frigo / base unit with mini-bar cabinet**

**finiture / finishes**

**nuvola / nuvola**

**frassino chiaro / frassino chiaro**

**lavagna / lavagna**

**sedia Nerja / Nerja chair**

**testa di moro - pag. 367 / dark brown - page 367**





10a - 10b - **10c**

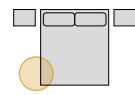

## Camera hotel

### Hotel room

**composizione libreria**  
bookcase configuration

L / W 423 cm  
H / H 239,6 cm  
P / D 45,4 cm

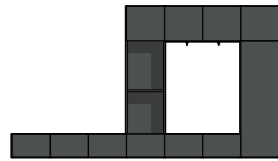

**elementi** / elements

**libreria a terra e sospesa**  
floorstanding and wall-mounted bookcase

**finiture** / finishes

**lavagna** / lavagna

**pouf Tokyo** / Tokyo ottoman  
TL32 - pag. 371 / TL32 - page 371

**piano sospeso con alzata sp. 5 cm** / 5 cm-thick wall-mounted top with upstand  
rovere cotto - pag. 356 / rovere cotto - page 356





**composizione parete**  
wall configuration

L / W 90 cm  
H / H 78,3 cm  
P / D 25 cm



**elementi / elements**

**boiserie Arnad** / Arnad wall panelling  
**specchio per boiserie** / mirror for wall panelling  
**casellari Zip12** / Zip12 shelving units

**finiture / finishes**

**rovere cotto** / rovere cotto  
**specchio chiaro** / light mirror



**libreria con gambe metalliche**  
bookcase with metal legs  
**rovere cotto, lavagna** - pag. 308  
rovere cotto, lavagna - page 308



**composizione letto**  
bed configuration

L / W 450 cm  
H / H 113 cm  
P / D 9,4 cm



**elementi / elements**

**testiera Cardiff** / Cardiff headboard  
**luci LED direzionali** / directional LED lights  
**cuscini per pannello** / panel cushions  
**Turca imbottita** / padded platform bed

**finiture / finishes**

**rovere cotto** / rovere cotto  
**spot T544** / spot T544



# 11a - 11b - 11c

## Camera hotel

### Hotel room

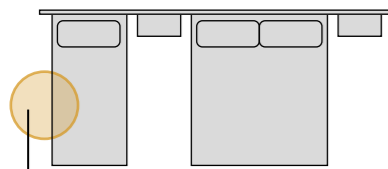

camera hotel multipla  
twin share hotel room

**Assicurare benessere e spazi ottimizzati attraverso una progettazione funzionale dei complementi. Grazie alla vasta gamma di combinazioni e all'ampia scelta di finiture disponibili la stanza multipla acquista carattere e si trasforma in un ambiente razionale, pur mantenendo tratti caldi e familiari.**

Providing optimized, feel-good spaces through the use of occasional furniture designed with functionality in mind. With a vast range of combinations and extensive finish options to choose from, twin share rooms have plenty of character and deliver a rational interior while still retaining a warm and friendly feel.

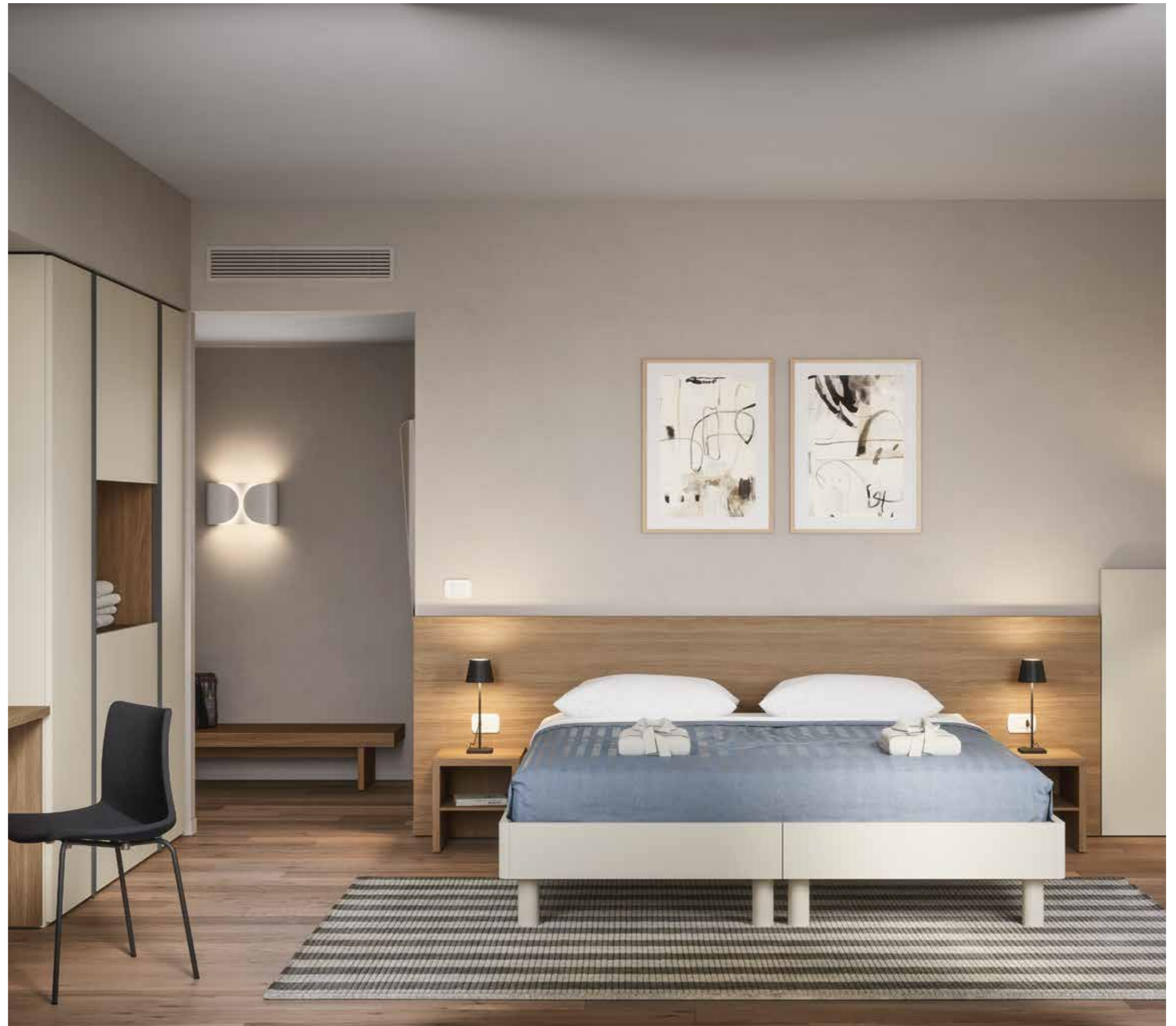



**pannello porta TV**  
TV mounting panel  
**canapa** / canapa

**sedia Sneek imbottita** / upholstered Sneek chair  
**spot T545, basamento R2 nero - pag. 367**  
spot T545, black R2 base - page 367

**composizione armadio**  
wardrobe configuration

**L / W 367,5 cm**  
**H / H 221,3 cm**  
**P / D 61 cm**



**elementi** / elements

**armadio battente** / hinged door wardrobe  
**scrivania con vano per frigo**  
desk with mini-bar cabinet

**finiture** / finishes

**noce naturale** / noce naturale  
**canapa** / canapa  
**lavagna** / lavagna



**contenitore appendiabiti Ginevra**

Ginevra coat cupboard  
noce naturale / noce naturale

**panca scendiletto / bed end bench**

noce naturale / noce naturale



**composizione parete**  
wall configuration

L / W 403,2 cm  
H / H 93 - 113 cm  
P / D 5 cm

L / W 367 cm  
H / H 93 - 113 cm  
P / D 5 cm



**elementi / elements**

testiera Cardiff / Cardiff headboard

**finiture / finishes**

noce naturale / noce naturale  
canapa / canapa

**Turche R180 stonato per contract**  
rounded R180 platform beds for contract market  
canapa - pag. 333 / canapa - page 333

comodini con ripiano / bedside tables with shelf  
noce naturale / noce naturale

11a - **11b** - 11c

## Camera hotel

 Hotel room

**letto Jerez** / Jerez bed  
smooth T152 - pag. 339  
smooth T152 - page 339

**basi a terra** / floorstanding base units  
**lavagna** - pag. 304 / lavagna - page 304



**composizione cabina**  
walk-in closet configuration

L / W 200 cm    L / W 200 cm  
H / H 239,6 cm    H / H 240 cm  
P / D 50,8 cm



**elementi** / elements

**cabina cremagliera** / slotted rail walk-in closet  
**pedana h 5 cm** / plinth H 5 cm  
**chiusura scorrevole** / sliding closing system

**finiture** / finishes

**rovere cotto** / rovere cotto  
**grafite** / grafite  
**vetro laccato nero** / black lacquered glass



**composizione libreria**  
bookcase configuration

L / W 355,6 cm  
H / H 221,3 cm  
P / D 33 - 112 - 219 cm



**elementi / elements**

**libreria a terra /** floorstanding bookcase  
**libreria con letto ribaltabile, divano e mensola**  
bookcase with drop-down bed, sofa and shelf  
**cuscini per pannello /** panel cushions  
**elementi Sudoku /** Sudoku units

**finiture / finishes**

**lavagna /** lavagna  
**rovere cotto /** rovere cotto  
**cross T504 /** cross T504



Camera hotel  
Hotel room





**composizione parete**  
wall configuration

L / W 270 cm  
H / H 74,9 cm  
P / D 61 cm



**elementi / elements**

**piano in appoggio** / sit-on-top top  
**basi a terra** / floorstanding base units  
**boiserie Arnad** / Arnad wall panelling  
**base con vano per frigo**  
base unit with mini-bar cabinet

**finiture / finishes**

**lavagna** / lavagna  
**rovere cotto** / rovere cotto

**pouf Tokyo** / Tokyo ottoman  
TL32 - pag. 371 / TL32 - page 371



11a - 11b - **11c**

## Camera hotel Hotel room

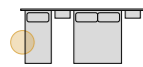

### composizione ingresso entrance configuration

L / W 203 cm  
H / H 238,9 cm  
P / D 49 cm

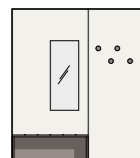

### elementi / elements

**boiserie Cover** / Cover wall panelling  
**specchio per boiserie** / mirror for wall panelling  
**portavaligie** / luggage shelf  
**pomoli appendiabiti** / clothes hanger knobs

### finiture / finishes

**olmo shade** / olmo shade  
**basalto** / basalto  
**specchio chiaro** / light mirror



**Turca R290 dritto** / straight R290 platform bed  
**olmo shade** - pag. 333 / olmo shade - page 333

**tavolino Orig** / Orig side table  
**basalto** - pag. 351 / basalto - page 351





**composizione libreria**  
bookcase configuration

L / W 329 cm  
H / H 221,3 cm  
P / D 35,4 - 110 cm



**elementi** / elements

**libreria con doppio letto ribaltabile orizzontale**  
bookcase with two horizontal drop-down beds  
**libreria a terra** / floorstanding bookcase

**finiture** / finishes

**olmo shade** / olmo shade  
**basalto** / basalto





**composizione armadio**  
wardrobe configuration

L / W 367 cm  
H / H 221,3 cm  
P / D 65,4 cm



**elementi / elements**

**armadio scorrevole / sliding door wardrobe**  
**cabina cremagliera / slotted rail walk-in closet**

**finiture / finishes**

**olmo shade / olmo shade**  
**basalto / basalto**

**composizione parete**  
wall configuration

L / W 330 cm  
H / H 111 cm  
P / D 49 cm

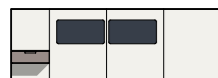

**elementi / elements**

**boiserie Cover / Cover wall panelling**  
**base sospesa / wall-mounted base unit**  
**cuscini per pannello / panel cushions**

**finiture / finishes**

**olmo shade / olmo shade**  
**basalto / basalto**  
**smooth T174 / smooth T174**



**pouf Tokyo / Tokyo ottoman**  
**TL36 - pag. 371 / TL36 - page 371**

# Un ambiente ottimizzato dove sentirsi come a casa

An optimized space providing a home away from home

L'aparthotel unisce la qualità del servizio d'hotel alla comodità di un appartamento; progettato pensando al quotidiano, lo spazio risulta funzionale grazie alla modularità degli elementi.

Serviced apartments combine the quality of hotel service with the convenience of an apartment; designed around everyday life, the resulting space is functional thanks to the furniture's modular design.

## aparthotel camera matrimoniale / serviced apartment double room

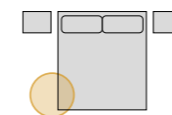

12a - pag. 196



12b - pag. 202

## aparthotel camera multipla / serviced apartment twin share room

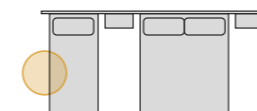

13a - pag. 206



13b - pag. 214



# 12a - 12b

## Aparthotel

### Serviced apartment

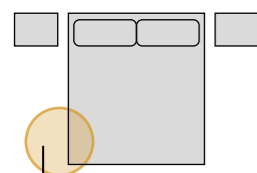

**aparthotel camera matrimoniale**  
serviced apartment double room

**Un aparthotel dove alloggiare sperimentando una sensazione di benessere e di calore; la cura dei dettagli e l'ottimizzazione degli spazi rende l'ambiente confortevole e perfetto per un soggiorno di lavoro o di piacere, dai tratti moderni, una soluzione intelligente che unisce organizzazione e comfort abitativo.**

A serviced apartment providing a place to stay with a warm, feel-good vibe. With attention to detail and optimized spaces, it provides the perfect, comfortable, modern-looking base whether you're travelling for business or pleasure; a smart solution that combines organization and occupant comfort.



**composizione parete**  
wall configuration

L / W 462,5 cm  
H / H 221,3 cm  
P / D 61 cm

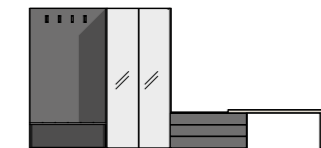

**elementi** / elements

**portavaligie con schiena**

luggage shelf with back panel

**ganci appendiabiti** / coat hooks

**armadio battente** / hinged door wardrobe

**base armadio** / wardrobe base unit

**piano in appoggio** / sit-on-top top

**finiture** / finishes

**cemento** / cemento

**frassino chiaro** / frassino chiaro

**specchio chiaro** / light mirror

**brunito** / bronze

**pouf Tokyo** / Tokyo ottoman  
TL34 - pag. 371 / TL34 - page 371



**composizione parete**  
wall configuration

L / W 510 cm  
H / H 112,8 cm  
P / D 48,5 cm



**elementi / elements**  
**boiserie Arnad** / Arnad wall panelling  
**luci LED direzionali** / directional LED lights  
**mensola sp. 3 cm** / 3 cm-thick shelf  
**basi a terra** / floorstanding base units  
**piano in appoggio** / sit-on-top top  
**seduta imbottita** / padded seat

**finiture / finishes**

**frassino chiaro** / frassino chiaro  
**spot T543** / spot T543  
**cemento** / cemento



**Turca R180 dritto** / straight R180 platform bed  
**cemento - pag. 333** / cemento - page 333

**comodino con ripiano** / bedside table with shelf  
**cemento / cemento**

**sedia Cannes** / Cannes chair  
**TL31 - pag. 369** / TL31 - page 369

**tavolo ribaltabile** / drop-down table  
**cemento - pag. 364** / cemento - page 364

12a - **12b**

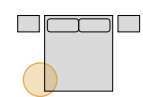

# Aparthotel

Serviced apartment



**composizione parete**  
wall configuration

L / W 330 cm  
H / H 18,3 cm  
P / D 45,8 cm

**elementi / elements**

**piano sospeso con alzata sp. 5 cm**  
5 cm-thick wall-mounted top with upstand

**finiture / finishes**

**noce naturale / noce naturale**

**Turca R290 stondato per contract**

rounded R290 platform bed for contract market  
**noce naturale - pag. 333 / noce naturale - page 333**

**tavolino Orig / Orig side table**  
**canapa - pag. 351 / canapa - page 351**

**sgabelli Sneek / Sneek stools**  
**J23, nero - pag. 370 / J23, black - page 370**





**composizione parete**  
wall configuration

L / W 510 cm  
H / H 93 cm  
P / D 50,8 cm



**finiture** / finishes  
**canapa** / canapa  
**noce naturale** / noce naturale  
**soft T563** / soft T563

**elementi** / elements  
**portavaligie** / luggage shelf  
**testiera Cardiff** / Cardiff headboard  
**copritestiera Singer** / Singer headboard cover

**composizione armadio**  
wardrobe configuration

L / W 182,5 cm  
H / H 257,9 cm  
P / D 67,5 cm

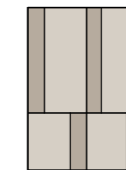

**elementi** / elements  
**armadio scorrevole** / sliding door wardrobe

**finiture** / finishes  
**canapa** / canapa  
**noce naturale** / noce naturale



# 13a - 13b

## Aparthotel

### Serviced apartment

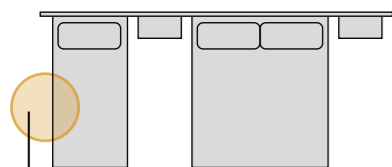

**aparthotel camera multipla**  
serviced apartment twin share room

**Condividere gli spazi senza rinunciare a privacy e comodità; le soluzioni modulari permettono di progettare ambienti vivibili e ottimizzati anche per spazi ridotti, da condividere. Un modo per far sentire i propri ospiti come a casa, senza rinunciare al servizio e alla praticità dell'albergo.**

Sharing spaces without having to say goodbye to privacy and comfort; modular solutions mean optimized, liveable spaces can be designed even where space is at a premium. A way to make your guests feel right at home, while still enjoying the service and practicality of a hotel.







**composizione libreria**  
bookcase configuration

L / W 315 cm  
H / H 221,3 cm  
P / D 33 - 97 cm



**elementi** / elements

**libreria con letto ribaltabile orizzontale - inferiore**  
bookcase with horizontal drop-down bed - bottom section  
**libreria a terra** / floorstanding bookcase

**finiture** / finishes

**bianco** / bianco

**letto Thun R70 stondato** / rounded R70 Thun bed  
**cemento** - pag. 336 / cemento - page 336

**comodini Parigi** / Parigi bedside tables  
**cemento, bianco** - pag. 350 / cemento, bianco - page 350





**composizione armadio**  
wardrobe configuration

L / W 242,5 cm  
H / H 257,9 cm  
P / D 60,6 cm

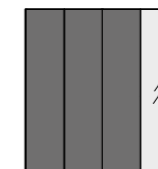

**elementi** / elements

**armadio battente** / hinged door wardrobe

**finiture** / finishes

**cemento** / cemento

**specchio chiaro** / light mirror

**nicel** / nichel



**composizione ingresso**  
entrance configuration

L / W 120 cm  
H / H 221,3 cm  
P / D 60,6 cm



**elementi / elements**  
**portavaligie con schiena**  
luggage shelf with back panel  
**ganci appendiabiti / coat hooks**

**finiture / finishes**

**cemento / cemento**  
**brunito / bronze**



**composizione parete**  
wall configuration

L / W 270 cm  
H / H 196 cm  
P / D 45,4 cm



**elementi / elements**  
**pensili / wall units**  
**libreria con gambe metalliche / bookcase with metal legs**

**finiture / finishes**

**cemento / cemento**  
**bianco / bianco**  
**vetro fumé / smoked glass**  
**lavagna / lavagna**

**sedie Giant / Giant chairs**  
J00 - pag. 366 / J00 - page 366

**tavolo Monaco / Monaco table**  
intonaco - pag. 363 / intonaco - page 363

13a - **13b**

## Aparthotel

 Serviced apartment



**letto Suez R120 con cuffia Bled**

R120 Suez bed with Bled headboard cover

**basalto, soft T563, fettuccia a contrasto CC15 - pag. 335**

basalto, soft T563, CC15 contrasting piping - page 335

**comodini Praga / Praga bedside tables**

**noce naturale, basalto - pag. 351 / noce naturale, basalto - page 351**





**composizione parete**  
wall configuration

L / W 240 cm  
H / H 76,1 cm  
P / D 45,8 cm



**elementi / elements**

**basi a terra** / floorstanding base units  
**basi sospese** / wall-mounted base units

**finiture / finishes**

**basalto** / basalto

**composizione cabina**  
walk-in closet configuration

L / W 312 cm  
H / H 257,9 cm  
P / D 47,4 cm



**elementi / elements**

**cabina a spalla**  
walk-in closet system with load-bearing side panels  
**portavaligie** / luggage shelf

**finiture / finishes**

**basalto** / basalto  
**noce naturale** / noce naturale

**pouf Tokyo** / Tokyo ottoman  
TL33 - pag. 371 / TL33 - page 371



**composizione parete**  
wall configuration

L / W 420 cm  
H / H 105 cm  
P / D 35,8 cm



L / W 180 cm  
H / H 105 cm  
P / D 70 cm



**elementi / elements**

**basi a terra / floorstanding base units**  
**piano scrivania sp. 5 cm con fianco**  
5 cm-thick desk top with side panel

**finiture / finishes**

**cashmere / cashmere**  
**basalto / basalto**  
**noce naturale / noce naturale**



**ganci appendiabiti**

coat hooks  
**brunito - pag. 303 / bronze - page 303**

**portavaligie con schiena**

luggage shelf with back panel  
**basalto / basalto**

**specchio / mirror**

**specchio chiaro / light mirror**



**sgabelli Sneek / Sneek stools**  
**J10, nero - pag. 370 / J10, black - page 370**

**casellario Zip12 / Zip12 wall unit**  
**basalto / basalto**



**divano Madrid / Madrid sofa**  
**soft T565, fettuccia a contrasto CC11 - pag. 372**  
soft T565, CC11 contrasting piping - page 372

**tavolino Orig / Orig side table**  
**cashmere, noce - pag. 351**  
cashmere, noce - page 351



# Una buona accoglienza significa progettare uno spazio funzionale e confortevole

Creating the perfect area  
to welcome guests is all  
about designing a functional,  
comfortable space

**La prima impressione su un albergo si ha dalla zona reception: deve essere elegante e piacevole, ma al tempo stesso molto comoda, per accogliere i visitatori dopo un viaggio. Il banco reception e l'area di attesa si fondono in un progetto studiato per offrire il massimo comfort e servizio.**

Guests get their first impression of a hotel from the reception area: it has to be elegant and attractive but, at the same time, supremely comfortable to accommodate weary travellers. The reception desk and waiting area are merged in a layout designed to offer unbeatable comfort and service.

## reception / reception area

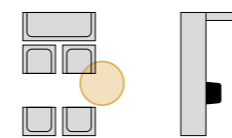

14a - pag. 222



14b - pag. 230

# 14a - 14b

## Reception

Reception area

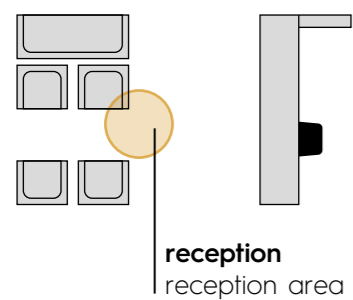

**Un ambiente che guarda il quotidiano andirivieni degli ospiti dell'albergo, diventando il sostituto del salotto di casa. Nei grandi alberghi l'esigenza di organizzazione e di praticità della reception accompagna la progettazione di uno spazio all'insegna del comfort.**  
A space that observes the daily comings and goings of guests, becoming the hotel equivalent of their lounge at home. In large hotels, the need for a reception area that is both organized and practical is accommodated in the design of a space that is also big on comfort.







**composizione libreria**  
bookcase configuration

L / W 408 cm  
H / H 294,5 cm  
P / D 45,4 cm

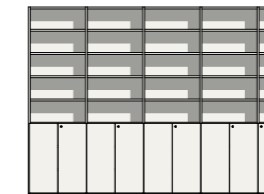

**elementi** / elements

**libreria a terra** / floorstanding bookcase

**finiture** / finishes

**olmo shade** / olmo shade



**composizione reception**  
reception area configuration

L / W 405 cm  
H / H 110 cm  
P / D 205 cm

L / W 400 cm  
H / H 75 cm  
P / D 200 cm

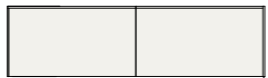

**elementi / elements**  
**scrivania con piano sp. 1,2 cm**  
desk with 1,2 cm-thick top  
**penisola con piano sp. 1,2 cm**  
desk return with 1,2 cm-thick top  
**banconi reception con fianchi sp. 3 cm**  
reception desks with 3 cm-thick side panels

**finiture / finishes**  
**olmo shade** / olmo shade  
**bianco** / bianco

**sedie Basilea con braccioli**  
Basilea chairs with armrests  
**TL32, nero - pag. 369**  
TL32, black - page 369



Reception  
Reception area



**divani Madrid** / Madrid sofas  
**cross T515, fettuccia a contrasto CC12** - pag. 372  
cross T515, CC12 contrasting piping - page 372  
**panca scendiletto** / bed end bench  
**lavagna** / lavagna





14a - 14b

# Reception Reception area



**sedie Sofia rete con braccioli**  
Sofia mesh chairs with armrests  
TL36, nero - pag. 368 / TL36, black - page 368

**divani Madrid / Madrid sofas**  
spot T544, fettuccia a contrasto CC11 - pag. 372  
spot T544, CC11 contrasting piping - page 372



**composizione reception**  
reception area configuration

L / W 393 cm  
H / H 111,5 cm  
P / D 166 cm

L / W 340 cm  
H / H 75 cm  
P / D 80 cm



**elementi / elements**

**scrivania con piano sp. 1,2 cm** / desk with 1,2 cm-thick top  
**libreria a terra** / floorstanding bookcase

**finiture / finishes**

**rovere cotto** / rovere cotto  
**canapa** / canapa  
**lavagna** / lavagna



**parete attrezzata**  
wall system

L / W 369 cm  
H / H 257,9 cm  
P / D 35,8 cm

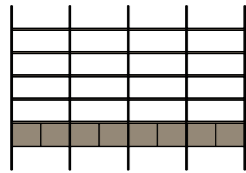

**elementi** / elements  
**sistema Uniko** / Uniko system

**finiture** / finishes

**rovere cotto** / rovere cotto  
**lavagna** / lavagna

**sedie Sneek lounge** / Sneek lounge chairs  
TF26, nero - pag. 371 / TF26, black - page 371

**tavolini Anversa** / Anversa occasional tables  
canapa, nero - pag. 365 / canapa, nero - page 365



**spazi commerciali**  
commercial spaces



# Funzionalità ed eleganza a misura di punto vendita

Functionality and elegance built for retail

**Realizzare un negozio significa soprattutto far coesistere stile e praticità. Grazie alla modularità degli elementi è infatti possibile progettare infinite soluzioni espositive che si integrano in modo perfetto con le aree riservate agli spazi di lavoro.**

**Il risultato: un ambiente che non passa inosservato.**

Fitting out a store means, above all, successfully marrying style and practicality. With the furniture's modular design, you can actually create endless display solutions that blend seamlessly with workspaces.

The result: an interior that is sure to turn heads.

## negozio - S / store - S

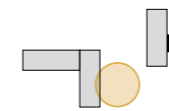

15a - pag. 238



15b - pag. 246

## negozio - L / store - L

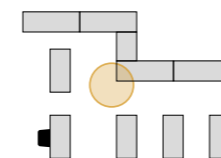

16a - pag. 252



16b - pag. 260

# 15a - 15b

## Negozio Store

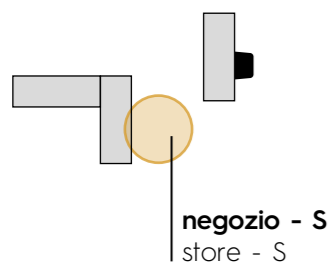

**L'esigenza in un negozio dalle dimensioni contenute, è quella di assicurare lo spazio espositivo per il prodotto, mantenendo lo stile e la giusta lettura del punto vendita. Grazie alla modularità degli elementi, la composizione con basi a terra esalta al massimo l'ambiente di vendita.**

In a store where space is at a premium, the challenge is having enough room to display the product, while still being true to the store's style and identity. The furniture's modular design allows the centrepiece with floorstanding base units to take the retail space to the next level.







**composizione libreria**  
bookcase configuration

L / W 303 cm  
H / H 184,5 cm  
P / D 35,4 cm



**elementi** / elements

**libreria sospesa** / wall-mounted bookcase

**finiture** / finishes

**nuvola** / nuvola

**noce naturale** / noce naturale

**vetro trasparente** / transparent glass

**bianco** / bianco

**composizione centro stanza**  
island configuration

L / W 240 cm  
H / H 108,5 cm  
P / D 80 cm



**elementi** / elements

**libreria a terra** / floorstanding bookcase

**piano scrivania sp. 3 cm con fianchi e schiena**

3 cm-thick desk top with side panels and back

**finiture** / finishes

**nuvola** / nuvola

**noce naturale** / noce naturale





**parete attrezzata**  
wall system

L / W 648 cm  
H / H 239,6 cm  
P / D 47,4 cm



**elementi / elements**

**cabina a spalla**  
walk-in closet system with load-bearing side panels  
**libreria a terra** / floorstanding bookcase

**finiture / finishes**

**nuvola** / nuvola  
**noce naturale** / noce naturale  
**vetro trasparente** / transparent glass  
**bianco** / bianco





**composizione libreria**  
bookcase configuration

L / W 183 cm  
H / H 294,5 cm  
P / D 35,4 cm



**elementi / elements**  
**libreria a terra / floorstanding bookcase**

**finiture / finishes**

**nuvola / nuvola**  
**vetro trasparente / transparent glass**  
**bianco / bianco**



**composizione centro stanza**  
island configuration

L / W 270 cm  
H / H 77,9 cm  
P / D 91,6 cm



**elementi / elements**  
**basi a terra / floorstanding base units**

**finiture / finishes**

**nuvola / nuvola**



# 15a - 15b

## Negozio Store

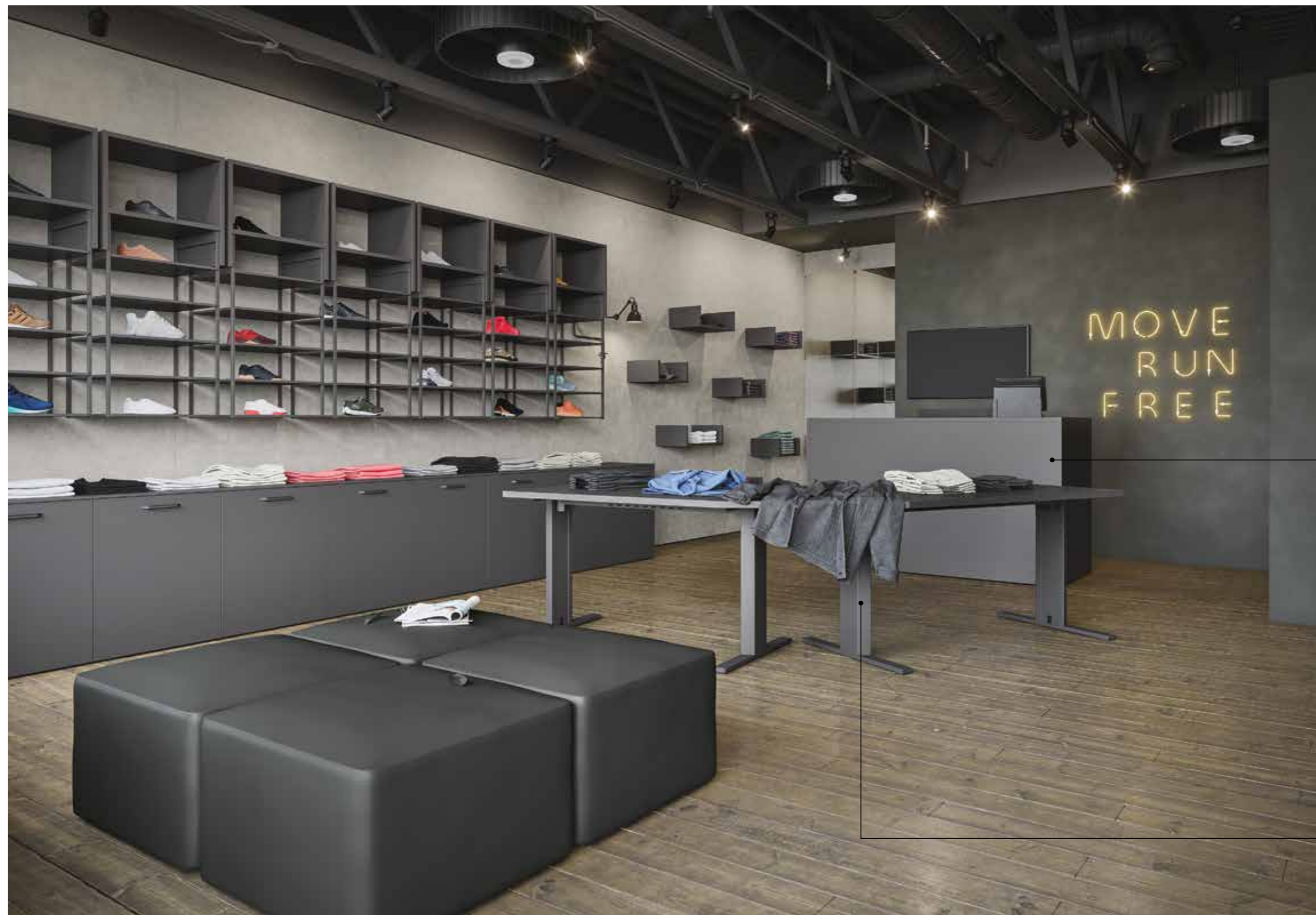
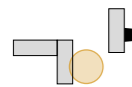

**sgabello Helsinky / Helsinky stool**  
TL34 - pag. 370 / TL34 - page 370  
**scrivania con piano sp. 1,2 cm**  
desk with 1,2 cm-thick top  
**lavagna - pag. 358 / lavagna - page 358**

**bancone reception con fianchi sp. 3 cm**  
reception desk with 3 cm-thick side panels  
**lavagna / lavagna**

**piano scrivania sp. 3 cm con gambe Prisma**  
3 cm-thick desk top with Prisma legs  
**lavagna - pag. 352 / lavagna - page 352**

**raccordo Trio-E**  
Trio-E connector  
**lavagna / lavagna**



**parete attrezzata**  
wall system

L / W 600 cm  
H / H 293,8 cm  
P / D 49 cm

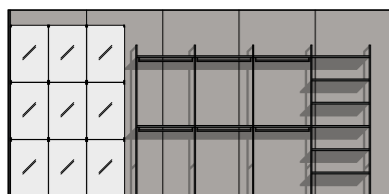

**elementi** / elements

**boiserie Cover** / Cover wall panelling  
**specchi per boiserie** / mirrors for wall panelling  
**sistema Uniko** / Uniko system

**finiture** / finishes

**intonaco** / intonaco  
**lavagna** / lavagna  
**specchio chiaro** / light mirror

**pouf Madrid** / Madrid ottoman  
**smooth T171** - pag. 372 / smooth T171 - page 372







**parete attrezzata**  
wall system

L / W 930 cm  
H / H 293,8 cm  
P / D 49 cm

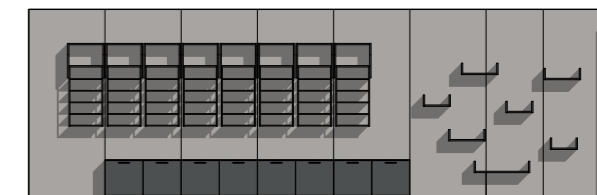

L / W 180 cm  
H / H 293,8 cm  
P / D 3,7 cm

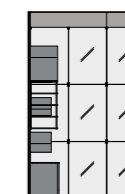

**elementi** / elements

**boiserie Cover** / Cover wall panelling  
**componenti Cover** / Cover components  
**basi a terra** / floorstanding base units  
**specchi per boiserie** / mirrors for wall panelling

**finiture** / finishes

**intonaco** / intonaco  
**lavagna** / lavagna  
**specchio chiaro** / light mirror



# 16a - 16b

## Negozio

### Store

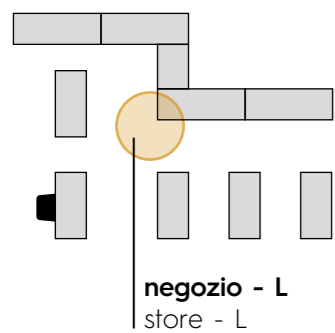

**Nello store di grandi dimensioni la metratura va sfruttata al massimo, realizzando con cura e attenzione le scelte espositive. La serie di librerie a parete moltiplica lo spazio, esaltando al massimo il prodotto. Gli arredi aiutano a delimitare i corridoi di passaggio all'interno del punto vendita.**

In a large store, floorspace needs to be exploited to the full, choosing display solutions with due care and attention. The run of wall-mounted bookcases multiplies the space, showing off the product to best effect. The furniture helps to direct customer flow through the store.



**composizione librerie**  
bookcase configurations

L / W 333 cm  
H / H 221,3 cm  
P / D 45,4 cm

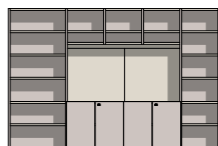

L / W 445 cm  
H / H 221,3 cm  
P / D 45,4 cm

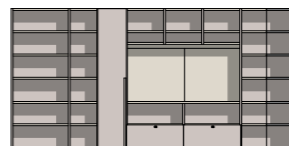

L / W 447,2 cm  
H / H 221,3 cm  
P / D 43 cm



L / W 420 cm  
H / H 221,3 cm  
P / D 45,4 cm



**elementi / elements**

**libreria a terra** / floorstanding bookcase  
**libreria ponte** / bridging bookcase  
**boiserie Arnad** / Arnad wall panelling  
**seduta imbottita** / padded seat

**finiture / finishes**

**frassino chiaro** / frassino chiaro  
**cashmere** / cashmere  
**thick T526** / thick T526

**sedie Sneek lounge** / Sneek lounge chairs  
**thick T527, bianco** - pag. 371  
thick T527, white - page 371

**tavolino Orig** / Orig side table  
**frassino chiaro, bianco** - pag. 351  
frassino chiaro, bianco - page 351







**parete attrezzata**  
wall system

L / W 500,9 cm  
H / H 221,3 cm  
P / D 45,4 cm



L / W 519 cm  
H / H 221,3 cm  
P / D 45,4 cm



**elementi / elements**

**libreria a terra** / floorstanding bookcase  
**libreria ponte** / bridging bookcase  
**boiserie Arnad** / Arnad wall panelling  
**seduta imbottita** / padded seat

**finiture / finishes**

**frassino chiaro** / frassino chiaro  
**cashmere** / cashmere  
**thick T526** / thick T526

**composizione centro stanza**  
island configuration

L / W 183 cm  
H / H 74,9 cm  
P / D 66 cm



**elementi / elements**

**librerie a terra** / floorstanding bookcases

**finiture / finishes**

**frassino chiaro** / frassino chiaro  
**cashmere** / cashmere



**bancone reception**  
reception desk

L / W 186 cm    L / W 180 cm  
H / H 110,7 cm    H / H 75 cm  
P / D 82 cm    P / D 80 cm



**elementi** / elements

**bancone reception con fianchi sp. 3 cm** / reception desk with 3 cm-thick side panels  
**scrivania con piano sp. 1,2 cm** / desk with 1,2 cm-thick top

**finiture** / finishes

**cashmere** / cashmere  
**bianco** / bianco





16a - **16b**

 **Negozio**  
Store



**composizione centro stanza**  
island configuration

L / W 280 cm  
H / H 75 cm  
P / D 70 cm

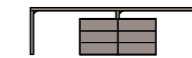

**elementi** / elements

**piano scrivania sp. 5 cm con fianchi** / 5 cm-thick desk top with side panels  
**basi a terra** / floorstanding base units

**finiture** / finishes

**basalto** / basalto  
**rovere cotto** / rovere cotto



**parete attrezzata**  
wall system

L / W 799,7 cm  
H / H 239,6 cm  
P / D 50,8 cm

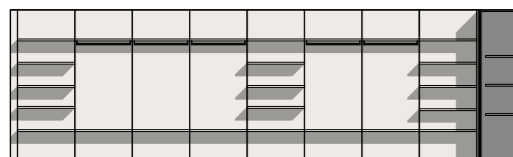

L / W 182,5 cm  
H / H 239,6 cm  
P / D 61,6 cm



**elementi** / elements

**cabina cremagliera** / slotted rail walk-in closet  
**armadio battente** / hinged door wardrobe

**finiture** / finishes

**calce** / calce  
**specchio chiaro** / light mirror  
**lavagna** / lavagna







**mensole in metallo** / metal shelves  
**basalto** / basalto

**piano scrivania sp. 5 cm con fianchi**  
 5 cm-thick desk top with side panels  
**rovere cotto** / rovere cotto

**parete attrezzata**  
 wall system

L / W 182,5 cm  
 H / H 239,6 cm  
 P / D 61,6 cm

L / W 330,5 cm  
 H / H 239,6 cm  
 P / D 51,1 cm

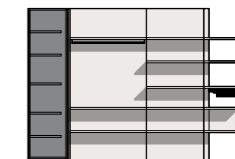
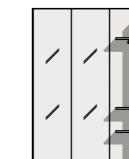

L / W 556,4 cm  
 H / H 239,6 cm  
 P / D 50,8 cm

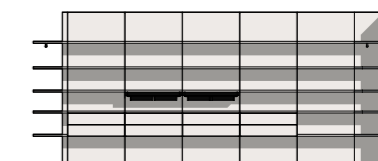

L / W 521,7 cm  
 H / H 239,6 cm  
 P / D 50,8 cm

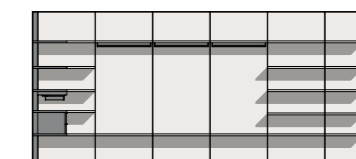

**elementi** / elements

**armadio battente** / hinged door wardrobe  
**cabina cremagliera** / slotted rail walk-in closet

**finiture** / finishes

**calce** / calce  
**specchio chiaro** / light mirror  
**lavagna** / lavagna

**divano Madrid** / Madrid sofa  
**cross T505, fettuccia a contrasto CC10** - pag. 372  
 cross T505, CC10 contrasting piping - page 372





**composizione centro stanza**  
island configuration

L / W 335 cm  
H / H 91,5 cm  
P / D 98,6 cm

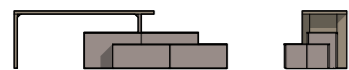

**elementi / elements**

**piano scrivania sp. 5 cm con fianchi** / 5 cm-thick desk top with side panels  
**basi a terra** / floorstanding base units

**finiture / finishes**

**basalto** / basalto  
**rovere cotto** / rovere cotto

**composizione centro stanza**  
island configuration

L / W 280 cm  
H / H 75 cm  
P / D 63,2 cm



**elementi / elements**

**piano scrivania sp. 5 cm con fianchi**  
5 cm-thick desk top with side panels  
**basi a terra** / floorstanding base units

**finiture / finishes**

**basalto** / basalto  
**rovere cotto** / rovere cotto





# Luogo di incontro e di convivialità

A place to gather and enjoy company

**Un concentrato di stile dall'aroma ricco e profumato. Il bistrot diventa uno spazio d'incontro dai tratti leggeri, che accoglie il quotidiano delle persone, tra lavoro e tempo libero. Ma è soprattutto un progetto ottimizzato dove l'estetica incontra le esigenze commerciali.**

A concentrate of style with a rich, enticing flavour. The bistro becomes a meeting space with a light and informal feel, accommodating the daily lives of people who come in on their lunch break or leisure time. Above all, though, it is an optimized design fusing aesthetics and business requirements.

## bistrot / bistro

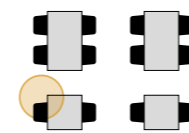

17a - pag. 270



17b - pag. 276



17c - pag. 280

# 17a - 17b - 17c

## Bistrot

### Bistro

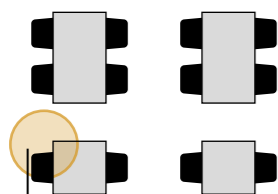

bistrot  
bistro

**Abbiamo tempo per un caffè? Un piccolo ambiente ricco di gusto, dove i diversi complementi trovano spazio e concorrono ad arredare in modo razionale. Il sistema Uniko, grazie alla grande modularità, assicura il massimo potere contenitivo e dona alla composizione una spiccata personalità.**

Have we got time to grab a coffee? A small interior brimming with taste, with various occasional pieces sitting comfortably in the space and helping create a rational fitout. With its wealth of modular options, the Uniko system provides tonnes of storage and gives the configuration a striking personality.







**parete attrezzata**  
wall system

L / W 550,8 cm  
H / H 257,9 cm  
P / D 45,8 cm

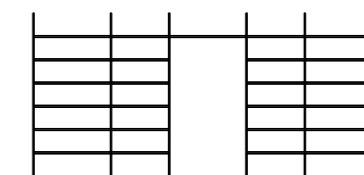

**elementi** / elements  
**sistema Uniko** / Uniko system

**finiture** / finishes  
**lavagna** / lavagna



**composizione libreria**  
bookcase configuration

L / W 183 cm  
H / H 239,6 cm  
P / D 35,4 cm



**elementi / elements**  
**libreria a terra**  
floorstanding bookcase

**finiture / finishes**

**lavagna / lavagna**  
**vetro trasparente / transparent glass**



**composizione parete**  
wall configuration

L / W 360 cm  
H / H 170 cm  
P / D 35,8 cm



**elementi / elements**  
**casellari / shelving units**  
**piano sospeso con alzata sp. 5 cm**  
5 cm-thick wall-mounted top with upstand

**finiture / finishes**

**rovere cotto / rovere cotto**





**sedie Sneek / Sneek chairs**  
J10, basamento R2 nero - pag. 366  
J10, black R2 base - page 366

**tavolini Anversa / Anversa occasional tables**  
**rovere cotto, nero - pag. 365**  
rovere cotto, nero - page 365

**sgabelli Sneek / Sneek stools**  
J10, nero - pag. 370 / J10, black - page 370



17a - **17b** - 17c

  **Bistrot**  
  Bistro



**composizione parete**  
wall configuration

L / W 270 cm  
H / H 58,9 cm  
P / D 35,8 cm



**elementi / elements**

**basi sospese / wall-mounted base units**

**finiture / finishes**

**bianco / bianco**

**boiserie Arnad / Arnad wall panelling**  
**calce, bianco, basalto - pag. 314**  
calce, bianco, basalto - page 314

**bancone reception**  
reception desk

L / W 206 cm  
H / H 111,5 cm  
P / D 82 cm

L / W 200 cm  
H / H 75 cm  
P / D 80 cm

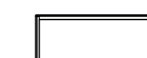

**elementi / elements**

**scrivania con piano sp. 1,2 cm**

desk with 1,2 cm-thick top

**bancone reception con fianchi sp. 3 cm**

reception desk with 3 cm-thick side panels

**finiture / finishes**

**bianco / bianco**

**basalto / basalto**



**composizione parete**  
wall configuration

L / W 228 cm  
H / H 74,9 cm  
P / D 45,8 cm



**elementi** / elements

**basi a terra** / floorstanding base units  
**libreria a terra** / floorstanding bookcase

**finiture** / finishes

**bianco** / bianco  
**basalto** / basalto

**sedie Cork** / Cork chairs  
J00 - pag. 366 / J00 - page 366

**piani scrivania sagomati sp. 3 cm con gambe Kike**  
3 cm-thick shaped desk tops with Kike legs  
**bianco** - pag. 352 / bianco - page 352





# 17a - 17b - 17c

## Bistrot

### Bistro

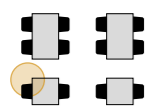

#### composizione bistrot

bistro configuration

L / W 421 cm  
H / H 114,5 cm  
P / D 61 cm



L / W 239 cm  
H / H 114,5 cm  
P / D 61 cm



#### elementi / elements

**basi a terra** / floorstanding base units  
**libreria a terra** / floorstanding bookcase  
**pannello sp. 3 cm** / 3 cm-thick panel

#### finiture / finishes

**intonaco** / intonaco  
**cemento** / cemento  
**noce naturale** / noce naturale

#### composizione libreria

bookcase configuration

L / W 306 cm  
H / H 294,5 cm  
P / D 33 cm

L / W 573 cm  
H / H 294,5 cm  
P / D 33 cm

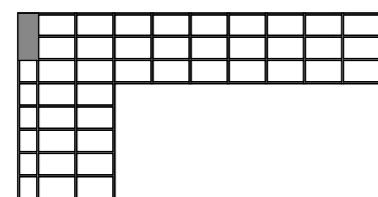
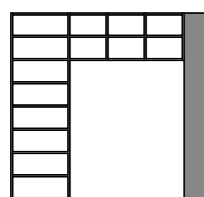

#### elementi / elements

**libreria a terra e sospesa** / floorstanding and wall-mounted bookcase

#### finiture / finishes

**intonaco** / intonaco

#### sgabelli Sneek / Sneek stools

J10, nero - pag. 370 / J10, black - page 370







**sedie Giant** / Giant chairs  
J00, J54 - pag. 366 / J00, J54 - page 366  
**tavolo Corby** / Corby table  
lavagna - pag. 361 / lavagna - page 361

**sgabelli Harlem** / Harlem stools  
TL32 - pag. 370 / TL32 - page 370  
**consolle bancone** / desk booths  
intonaco, noce naturale / intonaco, noce naturale





**sezione tecnica**  
technical section

# Il sistema cinquanta3

## The cinquanta3 system



**finiture e colori** / finishes and colours pag. 288

**tessuti** / fabrics pag. 290

**maniglie** / handles pag. 294

### il sistema / the system

|  |   |
|--|---|
|  | <b>contenitori</b> / storage units <span style="float: right;">pag. 304</span>  |
|  | <b>librerie</b> / bookcases <span style="float: right;">pag. 308</span>         |
|  | <b>sistema Uniko</b> / Uniko system <span style="float: right;">pag. 312</span> |
|  | <b>boiserie</b> / wall panelling <span style="float: right;">pag. 314</span>    |
|  | <b>armadi</b> / wardrobes <span style="float: right;">pag. 318</span>           |
|  | <b>cabine</b> / walk-in closets <span style="float: right;">pag. 326</span>     |

**letti** / beds pag. 330

**gruppi letto** / bedroom units pag. 348

**scrivanie** / desks pag. 352

**tavoli** / tables pag. 360

**sedute** / seating pag. 366



**singoli elementi del sistema**  
individual parts of the system

**composizione finita**  
finished configuration



# Finiture e colori

## Finishes and colours

### Finiture colore

Colour finishes

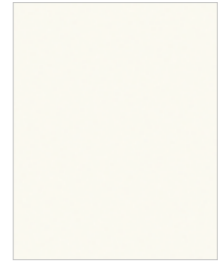

**01 bianco**  
basic

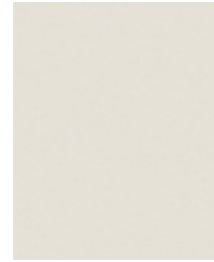

**50 nuvola**  
basic



**3C canapa**  
basic



**20 cashmere**  
smart



**55 sabbia**  
smart



**52 basalto**  
smart



**25 cemento**  
smart



**16 lavagna**  
smart

### Finiture ecolegno

Eco-wood finishes



**28 olmo shade**  
basic



**79 frassino chiaro**  
smart



**80 rovere cotto**  
smart



**54 noce naturale**  
smart

### Finiture materiche

Textured finishes



**57 calce**  
smart



**77 intonaco**  
smart

### Vetro standard

Standard glass



**VE vetro trasparente**  
VE transparent glass



**VF vetro fumé**  
VF smoked glass

### Vetro acidato

Etched glass



**VA vetro acidato**  
VA etched glass

### Vetro laccato

Lacquered glass



**VB vetro bianco**  
VB white glass

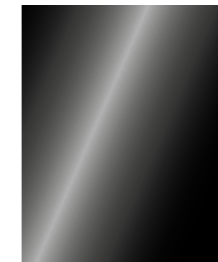

**VN vetro nero**  
VN black glass

### Specchio

Mirror



**SP specchio chiaro**  
SP light mirror



**SR specchio brunito**  
SR tinted mirror

### Finiture metalliche

Metal finishes



**6Z nichel**



**5Z titanio**



**3G grafite**

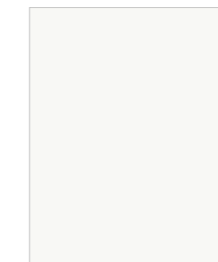

**01 bianco**



**16 lavagna**

# Tessuti

## Fabrics

### Tessuto Soft

Soft fabric



T563

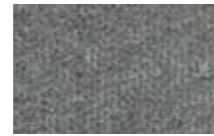

T564



T565



T560



T561



T562



T566



T567



T568

### Tessuto Spot

Spot fabric



T540



T541



T542

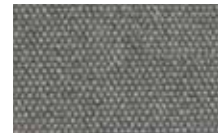

T543

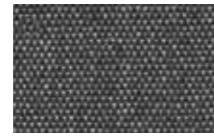

T544



T545



T546



T547



T548



T549



T551

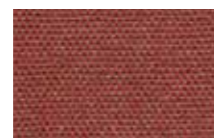

T550



T552



T553

### Tessuto Thick

Thick fabric



T527



T526



T524



T525



T530



T529



T523



T521



T528



T522

### Tessuto Cross

Cross fabric



T515



T513

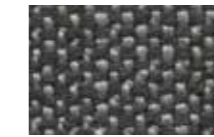

T512



T500



T502



T504

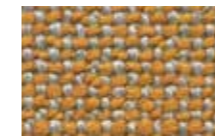

T505



T506



T508



# Tessuti Fabrics

## Ecopelle Smooth Smooth imitation leather



T150

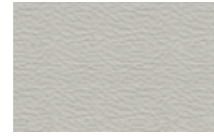

T164

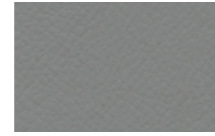

T175

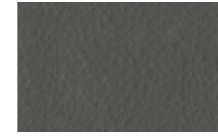

T167

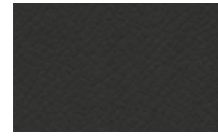

T171



T151



T170



T172



T152



T169



T173



T157



T174

# Tessuti speciali Special fabrics

## Feltro Felt



TF21



TF22



TF23



TF24



TF25



TF26

## Rivestimento per sedie su ruote Covers for swivel chairs



TL30



TL31



TL32



TL33



TL34



TL35



TL36

## Fettuccia per bordo a contrasto Contrasting piping



CC10



CC11



CC12



CC13



CC14



CC15

# Maniglie

## Handles



**A53 / A53L**  
7 x 7 x 2,5 cm



**A54 / A54L**  
7 x 7 x 2,5 cm



**A51**  
5,8 x 5,8 x 3 cm



**A28**  
5 x 1,8 x 0,3 cm



**A29 / A29L**  
11 x 4,5 x 0,2 cm



**A52**  
7,4 x 7,4 x 4 cm



**A40**  
20 x 1,8 x 0,6 cm



**A47**  
44,6/59,6/74,6/89,6/119,6 x 1,8 x 0,6 cm



# Maniglie

## Handles



**A68 / A68L**  
12 x 0,8 x 2 cm



**A69 / A69L**  
28,5 x 0,8 x 2 cm



**A70 / A70L**  
59,5 x 0,8 x 2 cm



**A37 / A37L**  
17 x 2,6 x 1,7 cm



**A60 / A60L**  
18 x 3,4 x 1,9 cm



**A72 / A72L**  
12,5 x 3,1 x 2,8 cm



**A74 / A74L**  
28,6 x 3,1 x 2,8 cm



**A75 / A75L**  
60 x 3,1 x 2,8 cm

# Maniglie

## Handles



**A57**  
16,9 x 1,1 x 3,2 cm



**A63**  
32,9 x 1,1 x 3,2 cm



**A58**  
23,5 x 1,2 x 3,2 cm



**A66**  
55,5 x 1,2 x 3,2 cm



**A59**  
18,2 x 1,5 x 2,6 cm



**A67**  
50,2 x 1,5 x 2,6 cm



**A73**  
84,6 x 1,1 x 3 cm



# Maniglie

## Handles



**A76 / A76L**  
110 x 3,1 x 2,8 cm



**A38 / A38L**  
128 x 2,6 x 1,7 cm



**A91 / A91L**  
219,2/237,5/255,8 x 3,1 x 2,8 cm



**A78 / A78L**  
110 x 0,8 x 2 cm



**A93**  
219,2/237,5/255,8 x 3,8 cm



**A95**  
H frontale / front x 4 x 2,2 cm



**A77 / A77L**  
110 x 3,4 x 1,9 cm



**A92 / A92L**  
219,2/237,5/255,8 x 3,4 x 1,9 cm

# Serrature

## Locks



**Serratura cilindrica**  
Cylindrical lock

**Serratura cilindrica con cifratura differenziata**  
Cylindrical lock keyed to differ

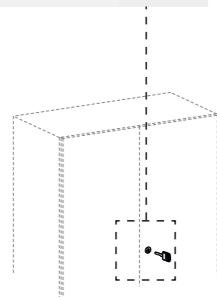

**Serratura cilindrica**  
Cylindrical lock

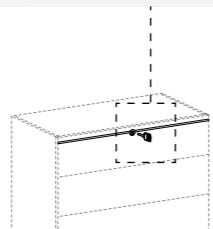

**Serratura ad asta differenziata**  
Espagnolette lock keyed to differ

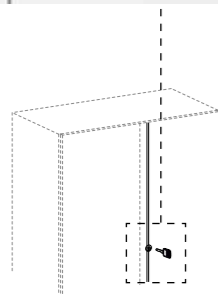

**Serratura cifrata**  
Combination lock

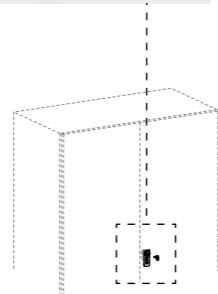

# Push-pull e Appendiabiti

## Push-to-Open systems and Coat Hooks



**Push-pull ante**  
Push-to-open for doors



**Push-pull cassetti**  
Push-to-open for drawers



**Gancio appendiabiti**  
Coat hook



**Pomolo appendiabiti**  
Clothes hanger knob



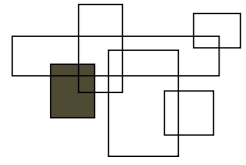

# Contenitori

## Storage units

**Flessibilità e adattabilità degli elementi contraddistinguono i contenitori. L'ampia modularità e la vasta gamma di finiture disponibili permette di progettare in piena libertà secondo lo stile dell'ambiente.**

The elements' flexibility and adaptability are distinguishing traits of the storage units. With plenty of module options and an extensive range of finishes to choose from, you can design a solution just the way you want to match the interior scheme.

### basi a terra

floorstanding base units

**altezze / heights**  
20 - 38,3 - 56,6 - 74,9 - 111,5

**larghezze / widths**  
45 - 60 - 75 - 90 - 120

**profondità / depths**  
35,4 - 45,4 - 60,6

### basi in appoggio e sospese

sit-on-top and wall-mounted base units

**altezze / heights**  
19,3 - 37,6 - 55,9 - 74,2 - 110,8

**larghezze / widths**  
45 - 60 - 75 - 90 - 120

**profondità / depths**  
35,4 - 45,4 - 60,6

### pensili

wall units

**altezze / heights**  
36,6 - 54,9 - 73,2 - 91,5

**larghezze / widths**  
30 - 45 - 60 - 75 - 90 - 120

**profondità / depths**  
35,4

### casellari

shelving units

**altezze / heights**  
36,6 - 54,9 - 73,2

**larghezze / widths**  
30 - 45 - 60 - 75 - 90

**profondità / depths**  
25 - 33

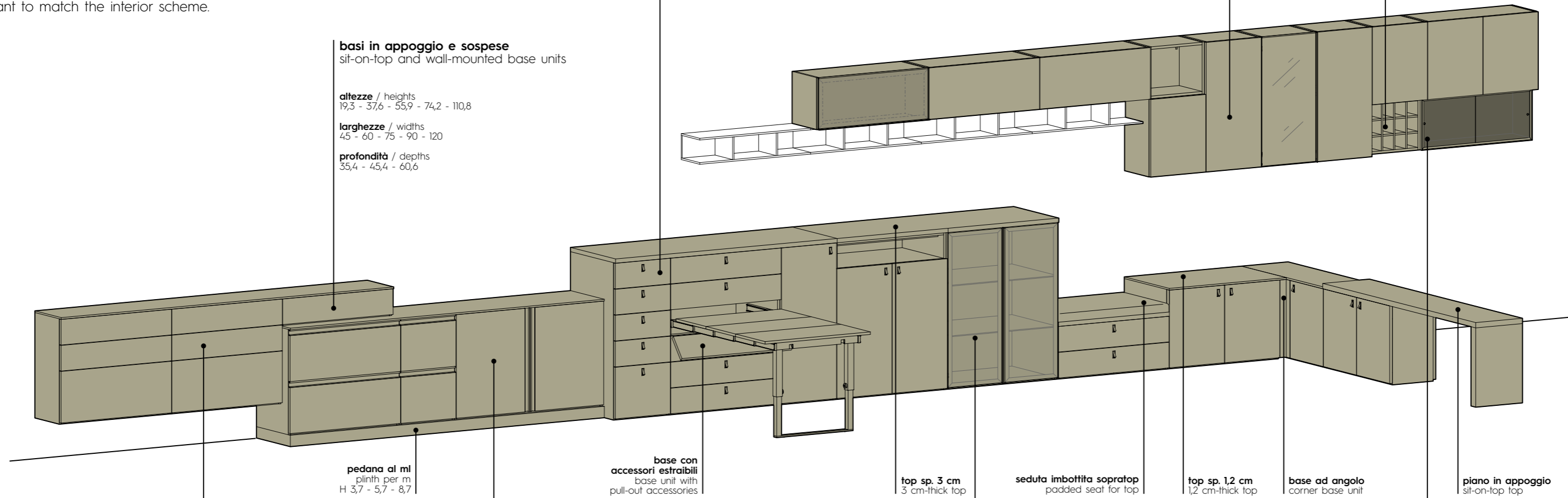

### Tipologia ante

Door type

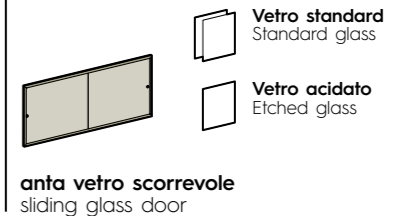
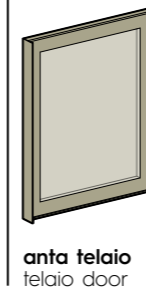
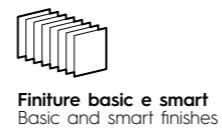
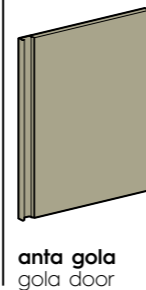
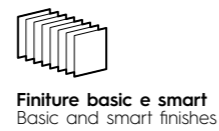
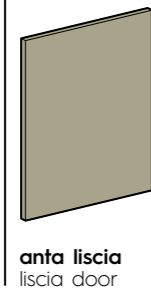

# Contenitori

## Storage units

### basi a terra / floorstanding base units

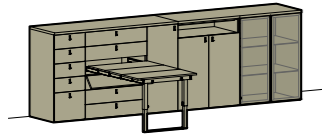

03b - pag. 54



06c - pag. 114



11b - pag. 187



15a - pag. 245

altre composizioni alle pagine / other configurations on pages  
28, 57, 67, 70, 77, 82, 87, 103, 130, 183, 200, 217, 218, 251, 261, 266, 278, 281

### basi in appoggio e sospese / sit-on-top and wall-mounted base units

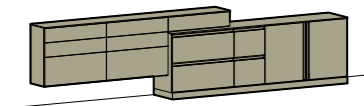

03c - pag. 61



08c - pag. 142



09a - pag. 148



17b - pag. 277

altre composizioni alle pagine / other configurations on pages  
38, 53, 111, 136, 189, 192, 217

### pensili e casellari / wall units and shelving units

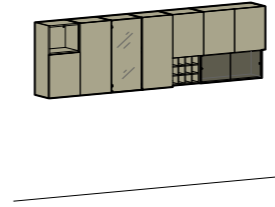

02b - pag. 38



03b - pag. 53



13a - pag. 213



17a - pag. 275

altre composizioni alle pagine / other configurations on pages  
20, 51, 53, 61, 83, 114, 127, 133, 148, 174, 219, 275



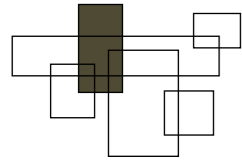

# Librerie Bookcases

Gli elementi libreria offrono un'ampia gamma di soluzioni, disponibili in differenti finiture e colori. Diverse tipologie di anta definiscono lo stile della composizione, caratterizzando l'ambiente in modo funzionale e personalizzato.

Bookcase units offer an extensive range of solutions, available in various finishes and colours. Different door types determine the style of the configuration, giving the room a distinctive functional and customized look.

## librerie ponte bridging bookcases

altezze / heights  
221,3 - 239,6 - 257,9 - 294,5

larghezze / widths  
150 - 180 - 210

profondità / depths  
35,4 - 45,4

## librerie sovrapposte sit-on-top bookcases

altezze per top 1,2 cm / heights for 1.2 cm top  
126,9 - 145,2 - 163,5 - 181,8 - 200,1 - 218,4 - 236,7  
255 - 273,3

altezze per top 3 cm / heights for 3 cm top  
125,1 - 143,4 - 161,7 - 180 - 198,3 - 216,6 - 234,9  
253,2 - 271,5

larghezze / widths  
30 - 45 - 60 - 90 - 120

profondità / depths  
35,4

## librerie a terra floorstanding bookcases

altezze / heights  
38,3 - 56,6 - 74,9 - 111,5 - 148,1 - 203  
221,3 - 239,6 - 257,9 - 294,5

larghezze / widths  
30 - 45 - 60 - 90 - 120

profondità / depths  
35,4 - 45,4

## librerie sospese wall-mounted bookcases

altezze con cappello / heights with top cover  
138,1 - 56,4 - 74,7 - 111,3 - 147,9 - 184,5

altezze con top intero / heights with one-piece top  
37,6 - 55,9 - 74,2 - 110,8

larghezze / widths  
30 - 45 - 60 - 90 - 120

profondità / depths  
35,4

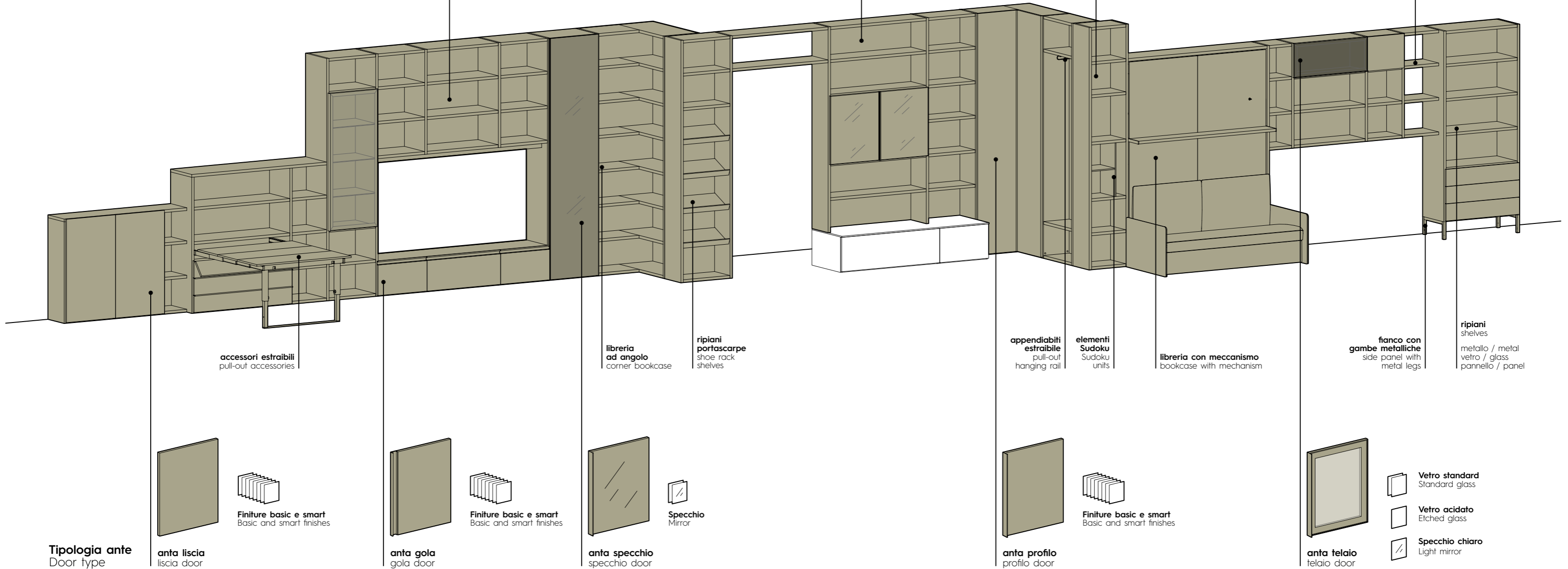

accessori estraibili  
pull-out accessories

libreria  
ad angolo  
corner bookcase

ripiani  
portascarpe  
shoe rack  
shelves

appendiabiti  
estraibile  
pull-out  
hanging rail

elementi  
Sudoku  
Sudoku  
units

libreria con meccanismo  
bookcase with mechanism

fianco con  
gambe metalliche  
side panel with  
metal legs

ripiani  
shelves  
metallo / metal  
vetro / glass  
pannello / panel

Tipologia ante  
Door type

anta liscia  
liscia door

Finiture basic e smart  
Basic and smart finishes

anta gola  
gola door

Finiture basic e smart  
Basic and smart finishes

anta specchio  
specchio door

Specchio  
Mirror

anta profilo  
profilo door

Finiture basic e smart  
Basic and smart finishes

anta telaio  
telaio door

Vetro standard  
Standard glass  
Vetro acidato  
Etched glass  
Specchio chiaro  
Light mirror

**librerie a terra** / floorstanding bookcases

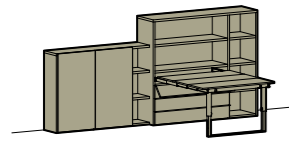

**01b** - pag. 25



**02c** - pag. 40



**08c** - pag. 145



**11c** - pag. 191

**altre composizioni alle pagine** / other configurations on pages  
23, 35, 40, 67, 70, 75, 88, 90, 92, 93, 99, 100, 112, 117, 123, 125, 127, 140, 149, 152, 172,  
184, 208, 225, 231, 241, 243, 254, 257, 274, 278, 281

**librerie sospese** / wall-mounted bookcases

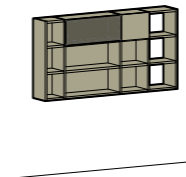

**02b** - pag. 37



**05b** - pag. 88



**09a** - pag. 149



**15a** - pag. 241

**altre composizioni alle pagine** / other configurations on pages  
92, 93, 172, 280

**librerie ponte** / bridging bookcases

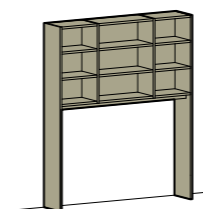

**06c** - pag. 117



**16a** - pag. 254

**altra composizione alla pagina** / other configuration on page  
257



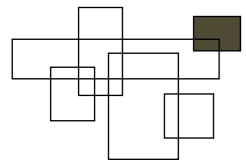

# Sistema Uniko

## Uniko system

Un sistema caratterizzato da montanti che sostengono gli elementi della composizione. Una soluzione pratica e flessibile che arreda mantenendo gli spazi ariosi. Gli elementi sono disponibili in un'ampia gamma di finiture e colori.

A system featuring uprights that support the configuration's various elements. A practical and flexible solution that furnishes spaces while keeping them light and airy. The elements come in a wide range of finishes and colours.

# Sistema Uniko

## Uniko system

sistema Uniko / Uniko system

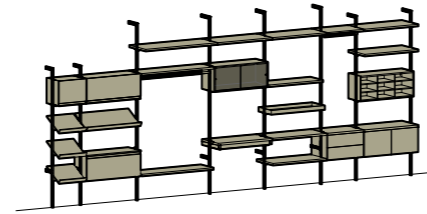

01c - pag. 31



07c - pag. 133



14b - pag. 232



15b - pag. 248

altre composizioni alle pagine / other configurations on pages  
78, 153, 170, 273

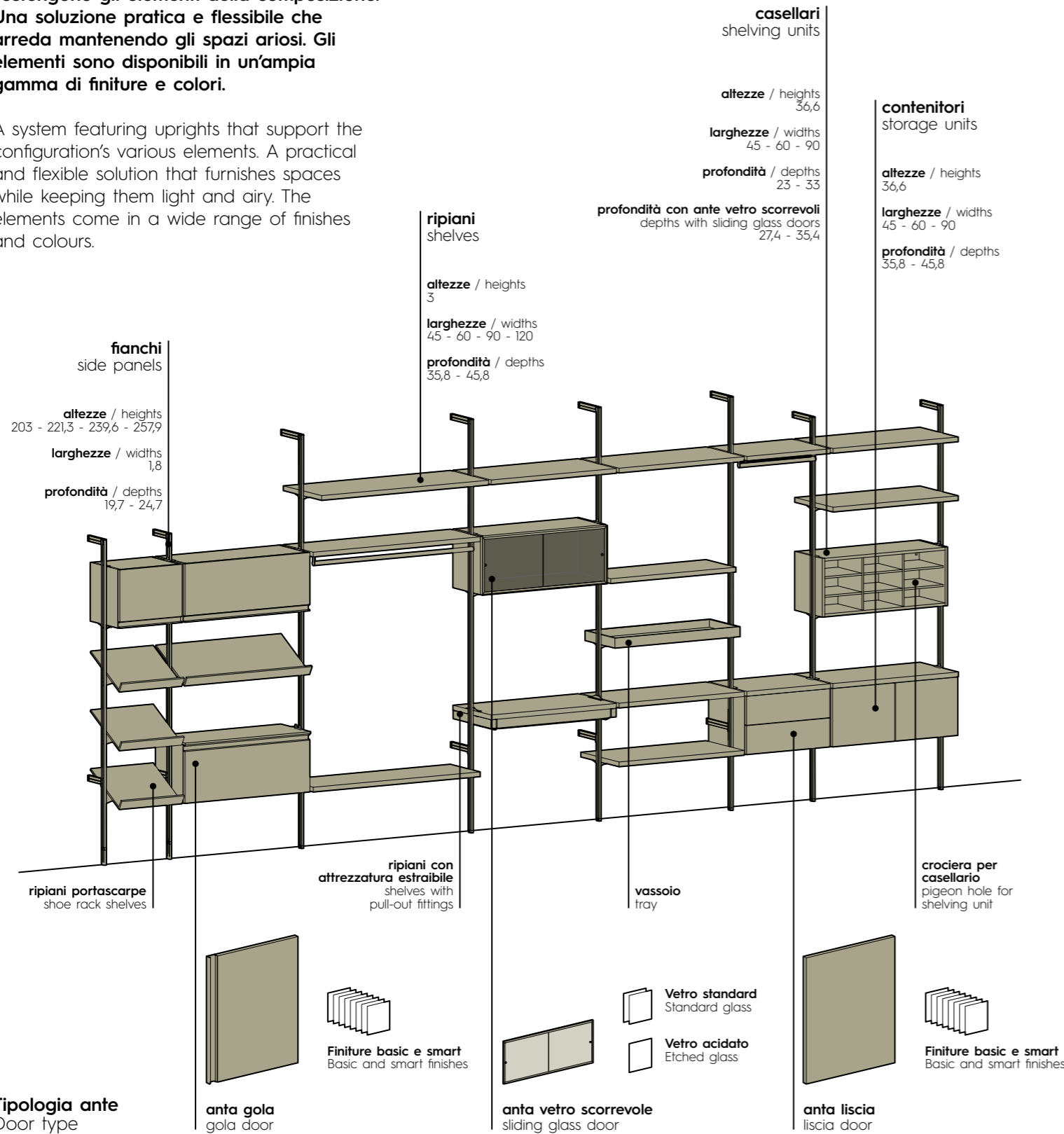

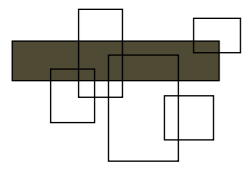

# Boiserie

## Wall panelling

Un elemento che arreda e completa la composizione, attrezzabile con mensole, pensili, basi a terra o sospese. Le diverse finiture e i colori disponibili permettono ampia possibilità di personalizzazione.

An element that adds a decorative finishing touch to the configuration, accommodating shelves, wall units, and floorstanding or wall-mounted base units. The various finish and colour options provide plenty of scope for customizing.

### boiserie Arnad

Arnad wall panelling

**pannelli / panels**  
**altezze / heights**  
 36,3 - 75,2 - 91,5 - 109,8  
**larghezze / widths**  
 60 - 90 - 120  
**profondità / depths**  
 2,9

### boiserie Cover

Cover wall panelling

**pannelli / panels**  
**altezze / heights**  
 111,5 - 129,8 - 148,1 - 202,3  
 221,3 - 239,6 - 257,9 - 294,5  
**larghezze / widths**  
 45 - 60 - 90 - 120  
**profondità / depths**  
 3,3

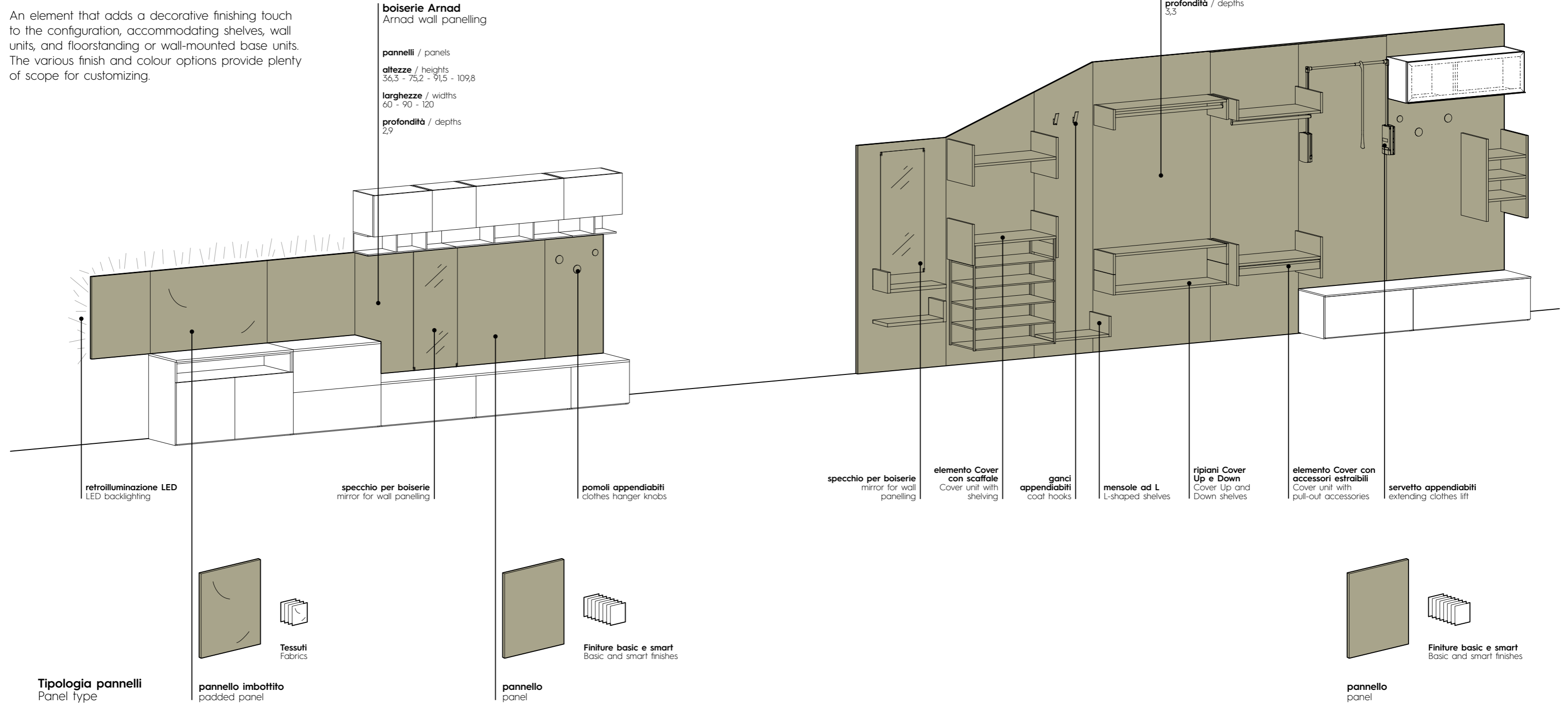



# Boiserie

Wall panelling

## boiserie Arnad / Arnad wall panelling

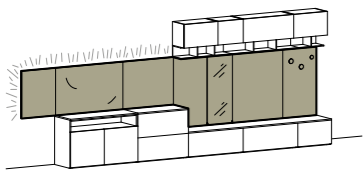

01a - pag. 23



07b - pag. 128



10b - pag. 169



12a - pag. 200

altre composizioni alle pagine / other configurations on pages  
35, 93, 136, 148, 174, 187, 254, 257, 277

## boiserie Cover / Cover wall panelling

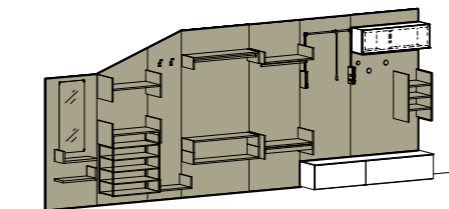

02b - pag. 38



03c - pag. 61



11c - pag. 188



15b - pag. 248

altre composizioni alle pagine / other configurations on pages  
107, 192, 251

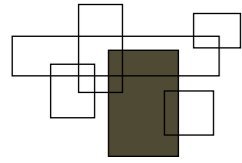

# Armadi Wardrobes

Progettati per il contenimento, permettono di organizzare lo spazio grazie alla grande modularità degli elementi disponibili. Perfetti per ottimizzare lo spazio e renderlo unico, scegliendo tra la vasta gamma di colori e finiture quelli più adatti.

Designed for storage needs, the units come with a huge range of module options, making them perfect for organizing a space. Perfect for optimizing the space and making it unique, choosing the most appropriate colours and finishes from the extensive range.

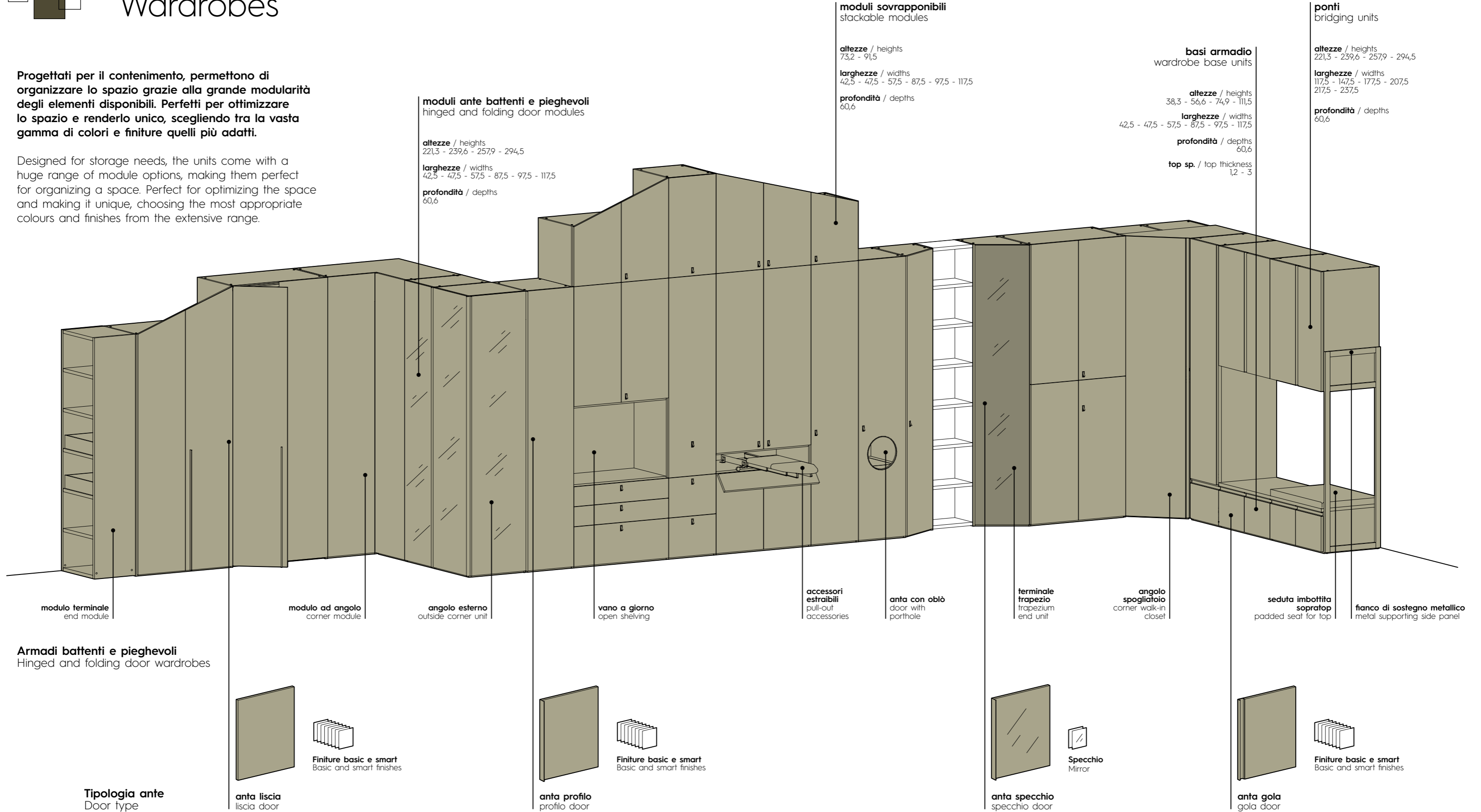

**moduli sovrapponibili**  
stackable modules

**altezze / heights**  
73,2 - 91,5

**larghezze / widths**  
42,5 - 47,5 - 57,5 - 87,5 - 97,5 - 117,5

**profondità / depths**  
60,6

**moduli ante battenti e pieghevoli**  
hinged and folding door modules

**altezze / heights**  
221,3 - 239,6 - 257,9 - 294,5

**larghezze / widths**  
42,5 - 47,5 - 57,5 - 87,5 - 97,5 - 117,5

**profondità / depths**  
60,6

**ponti**  
bridging units

**altezze / heights**  
221,3 - 239,6 - 257,9 - 294,5

**larghezze / widths**  
117,5 - 147,5 - 177,5 - 207,5  
217,5 - 237,5

**profondità / depths**  
60,6

**basi armadio**  
wardrobe base units

**altezze / heights**  
38,3 - 56,6 - 74,9 - 111,5

**larghezze / widths**  
42,5 - 47,5 - 57,5 - 87,5 - 97,5 - 117,5

**profondità / depths**  
60,6

**top sp. / top thickness**  
1,2 - 3

**modulo terminale**  
end module

**modulo ad angolo**  
corner module

**angolo esterno**  
outside corner unit

**vano a giorno**  
open shelving

**accessori estraibili**  
pull-out accessories

**anta con oblò**  
door with porthole

**terminale trapezio**  
trapezium end unit

**angolo spogliatoio**  
corner walk-in closet

**seduta imbottita**  
padded seat for top

**fianco di sostegno metallico**  
metal supporting side panel

**Armadi battenti e pieghevoli**  
Hinged and folding door wardrobes

**Tipologia ante**  
Door type

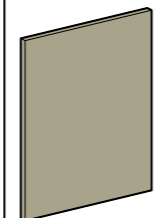

**anta liscia**  
liscia door



**Finiture basic e smart**  
Basic and smart finishes

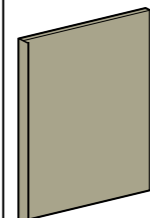

**anta specchio**  
specchio door



**Finiture basic e smart**  
Basic and smart finishes

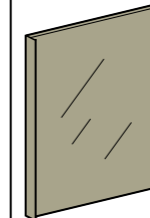

**anta specchio**  
specchio door



**Specchio**  
Mirror

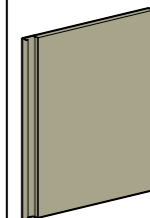

**anta gola**  
gola door



**Finiture basic e smart**  
Basic and smart finishes



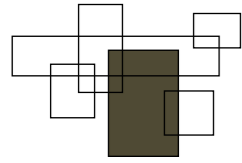

# Armadi Wardrobes

## Service Service

**altezze / heights**  
221,3 - 239,6 - 257,9 - 294,5

**larghezze / widths**  
72,5 - 87,5 - 97,5 - 117,5

**profondità / depths**  
72,4

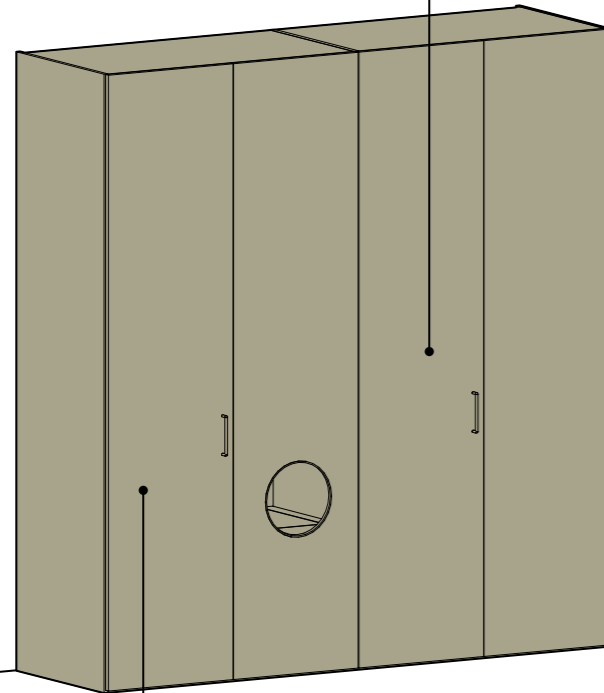

**Armadi Service**  
Service cupboards

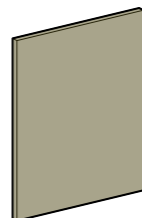

**anta liscia**  
liscia door



**Finiture basic e smart**  
Basic and smart finishes

**Tipologia ante**  
Door type

## Light Light

**altezze / heights**  
221,3 - 257,9

**larghezze / widths**  
42,9 - 87,6

**profondità / depths**  
60,6

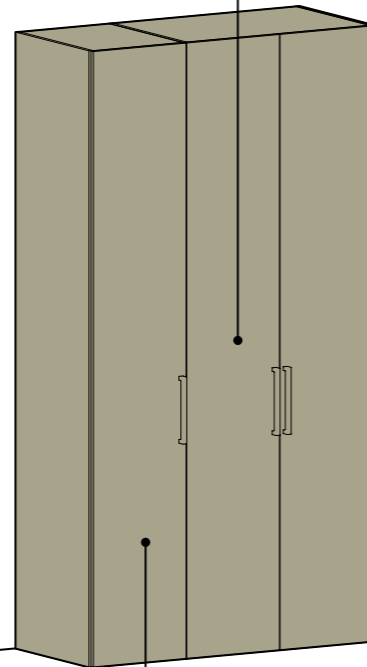

**Armadi Light**  
Light wardrobes

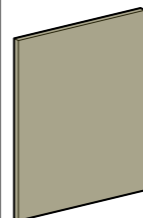

**anta liscia**  
liscia door



**Finiture**  
Finishes  
Bianco, Nuvola

## moduli ante scorrevoli sliding door modules

**altezze / heights**  
221,3 - 239,6 - 257,9

**larghezze / widths**  
72,5 - 87,5 - 97,5

**profondità / depths**  
64,2 - 66,3 - 67,5

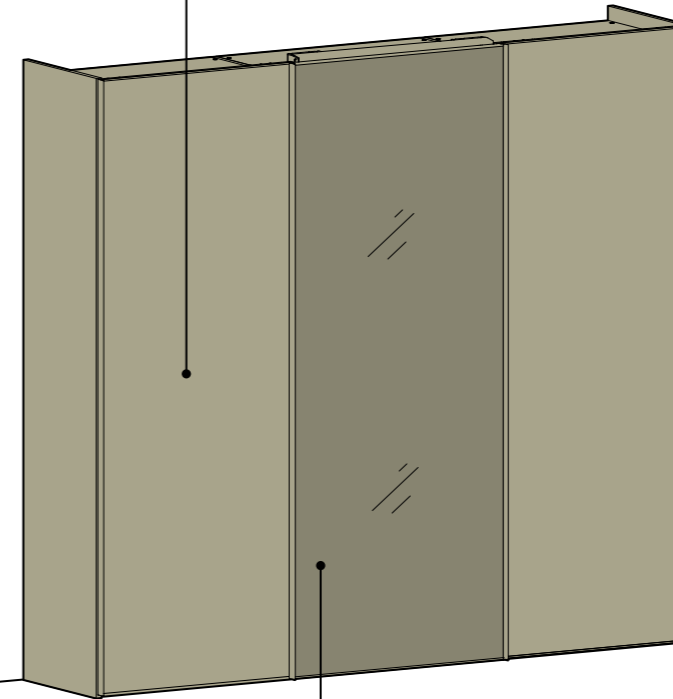

**Armadi scorrevoli**  
Sliding door wardrobes

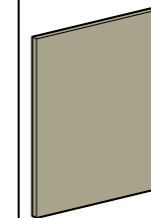

**anta liscia**  
liscia door

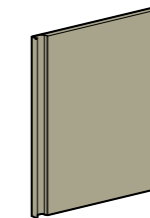

**anta gola**  
gola door

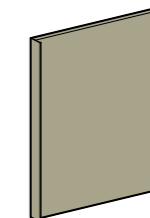

**anta profilo**  
profilo door

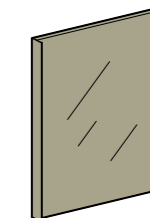

**anta specchio**  
specchio door

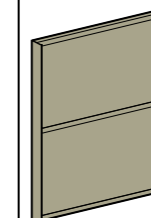

**anta cornice**  
cornice door

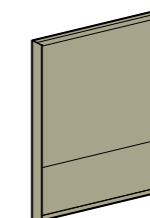

**anta telaio A**  
telaio A door

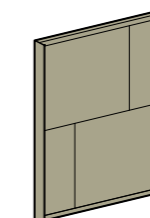

**anta telaio B**  
telaio B door



**Finiture basic e smart**  
Basic and smart finishes



**Finiture specchio**  
Mirror finishes

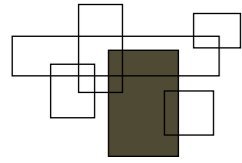

# Armadi Wardrobes

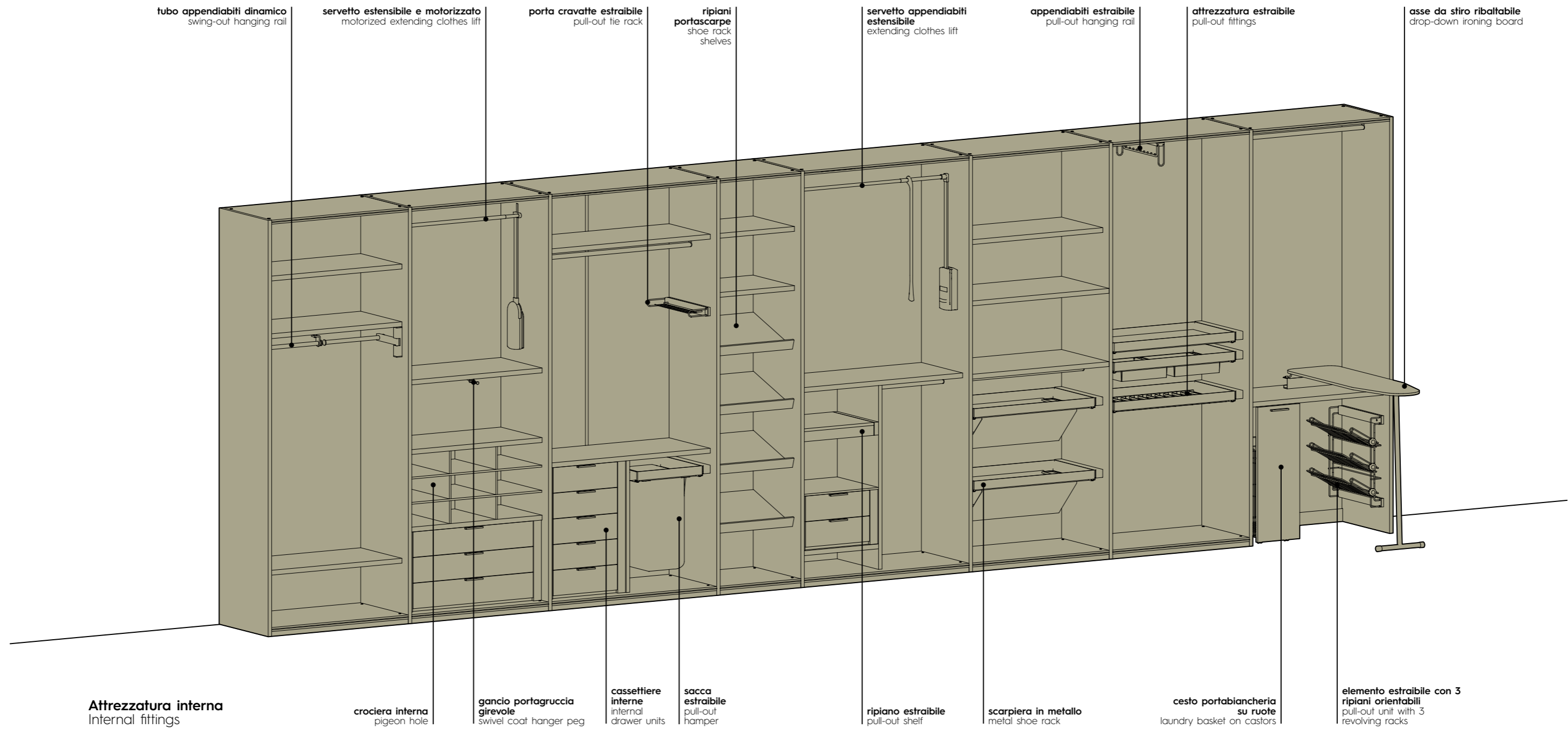



anta battente e pieghevole / hinged and folding door

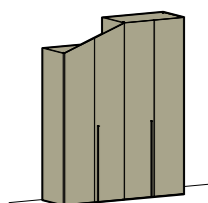

04b - pag. 71



08a - pag. 136



10a - pag. 165



13a - pag. 211

altre composizioni alle pagine / other configurations on pages  
35, 51, 83, 84, 136, 157, 179, 199, 262, 265

basi armadio / wardrobe base units



05a - pag. 83



12a - pag. 199

altre composizioni alle pagine / other configurations on pages  
35, 51

ponti / bridging units

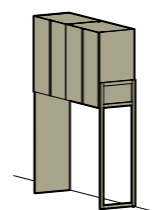

02a - pag. 35



05a - pag. 84

altra composizione alla pagina / other configuration on page  
83

anta scorrevole / sliding door

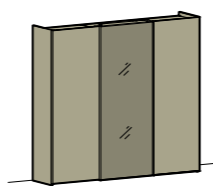

06b - pag. 107



11c - pag. 192



12b - pag. 205

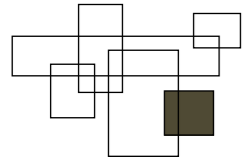

# Cabine

## Walk-in closets

Le cabine si caratterizzano per l'ampia flessibilità compositiva. Sono adattabili alle diverse tipologie di stanza, anche mansardata. Per maggior pulizia e ordine, è possibile completare lo spazio cabina con chiusure battenti, pieghevoli o scorrevoli.

Walk-in closets stand out for their impressive modular flexibility. They can be tailored to suit rooms of various kinds, even attic spaces. For a cleaner and tidier look, the walk-in closet space can be finished off with hinged, folding or sliding closing systems.

### cabina armadio walk-in closet

**altezze / heights**  
219,3 - 237,6 - 255,9 - 292,5

**larghezze / widths**  
42,5 - 47,5 - 57,5 - 87,5 - 97,5 - 117,5

**profondità / depths**  
51,8

**attrezzatura interna vedi pag. 298**  
internal fittings page 298

### cabina a spalla walk-in closet system with load-bearing side panels

**altezze / heights**  
221,3 - 239,6 - 257,9 - 294,5

**larghezze / widths**  
48 - 63 - 93 - 123

**profondità / depths**  
43 - 44,5

### cabina cremagliera slotted rail walk-in closet

**altezze / heights**  
221,3 - 239,6 - 257,9

**larghezze / widths**  
45 - 60 - 90 - 120

**profondità / depths**  
40,8 - 50,8

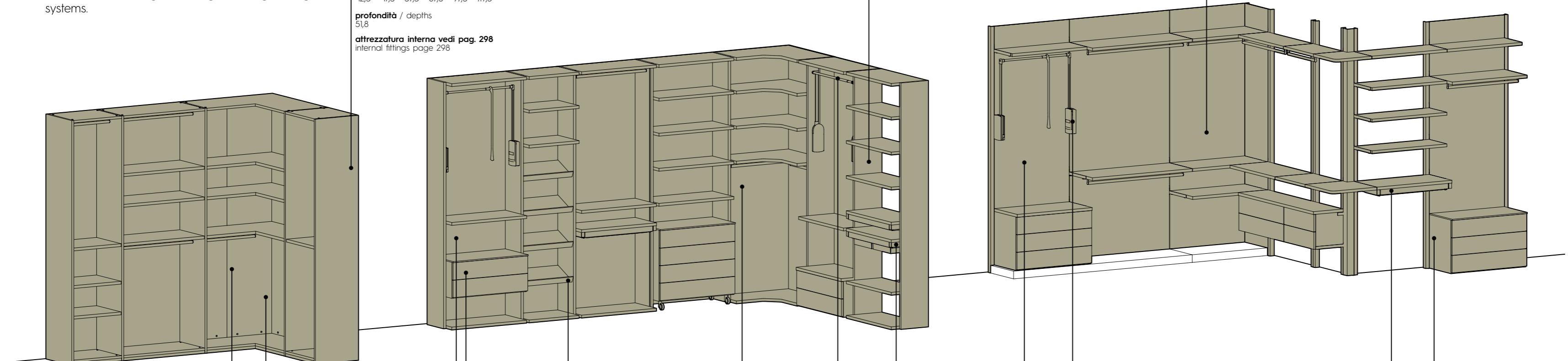

**Attrezzatura interna**  
Internal fittings

**modulo ad angolo**  
corner module

**cassettiere**  
drawer units

a terra / floorstanding  
sospese / wall-mounted  
su ruote / on castors

**ripiani  
portascarpe**  
shoe rack  
shelves

**colonna ad angolo**  
corner column

**servetto  
estensibile e  
motorizzato**  
motorized  
extending  
clothes lift

**attrezzatura estraibile**  
pull-out fittings

**servetto estensibile**  
extending clothes lift

**attrezzatura estraibile**  
pull-out fittings

**cassettiere** drawer units  
a terra / floorstanding  
sospese / wall-mounted  
in appoggio / sit-on-top



**Finiture**  
Finishes  
Nuvola



**Finiture basic e smart**  
Basic and smart finishes



**Finiture basic e smart**  
Basic and smart finishes



# Cabine

Walk-in closets

## **cabina a spalla** / walk-in closet system with load-bearing side panels

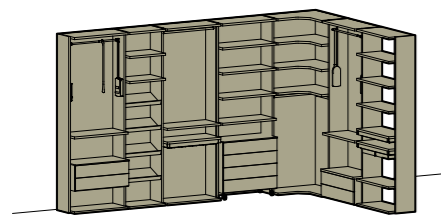

**13b** - pag. 217



**15a** - pag. 243

**altra composizione alla pagina** / other configuration on page 170

## **cabina cremagliera** / slotted rail walk-in closet

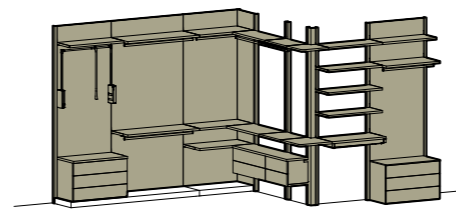

**10a** - pag. 165



**11b** - pag. 183



**11c** - pag. 192



**16b** - pag. 262

**altra composizione alla pagina** / other configuration on page 265

# Letti componibili

## Modular beds

**Letti in nobilitato**  
Beds in foil-wrapped finish

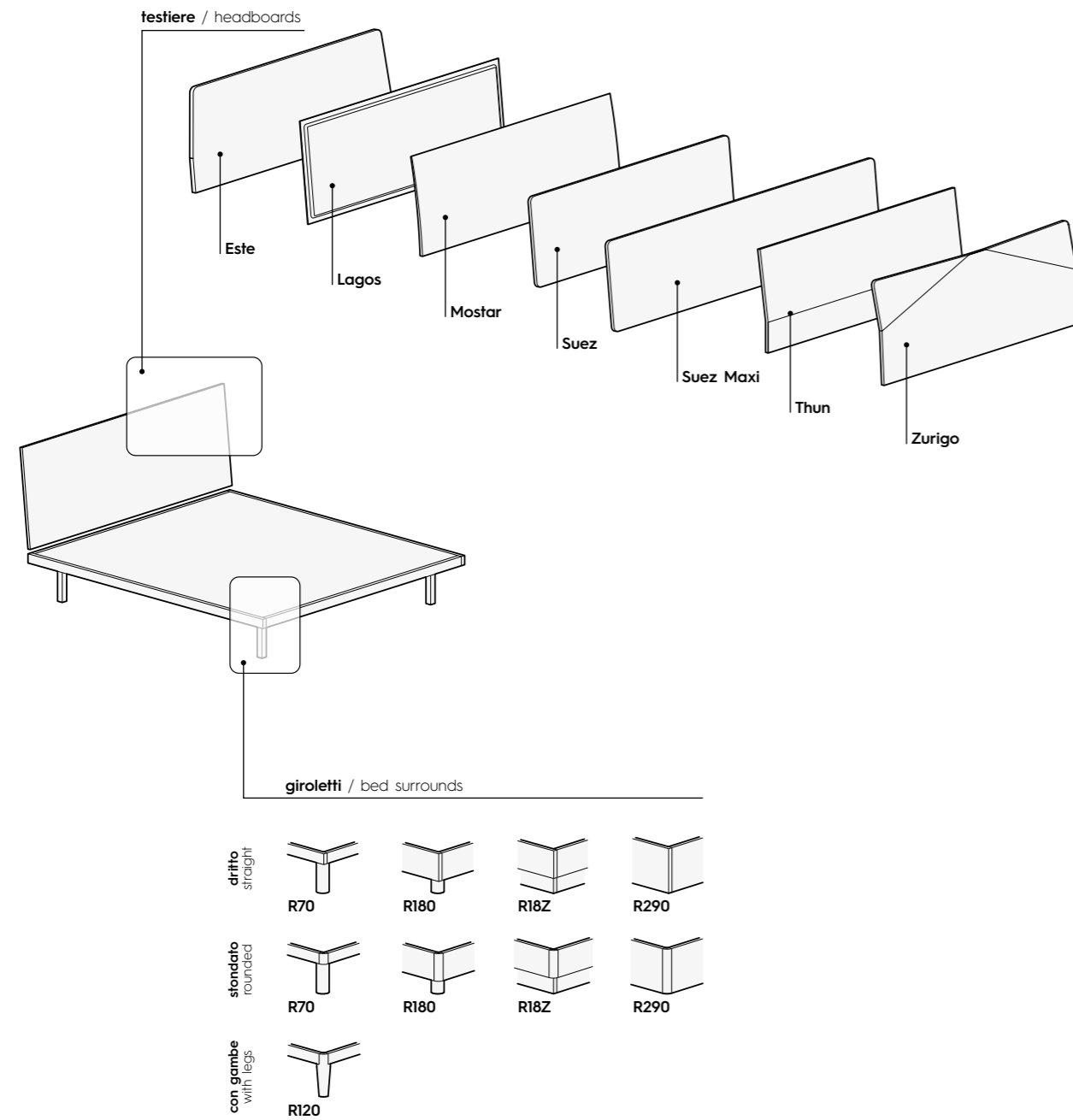

**Letti imbottiti**  
Padded beds

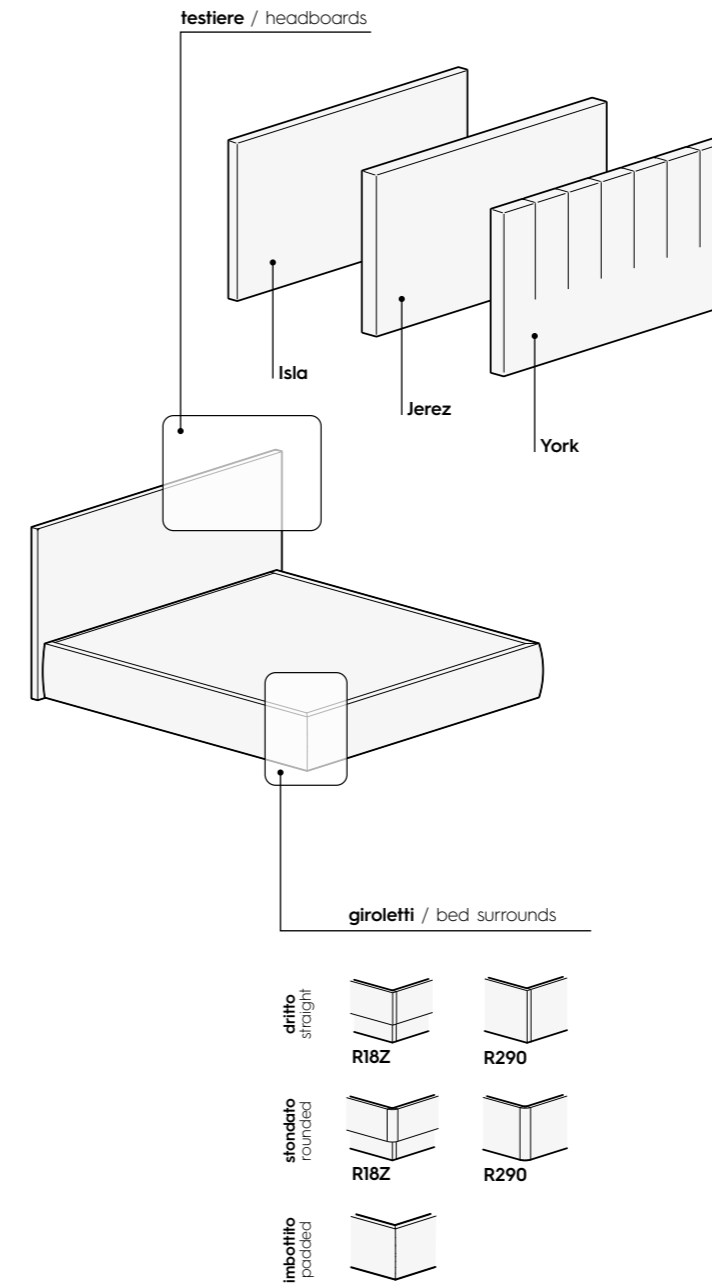



# Letti imbottiti

## Padded beds

Letti imbottiti  
Padded beds

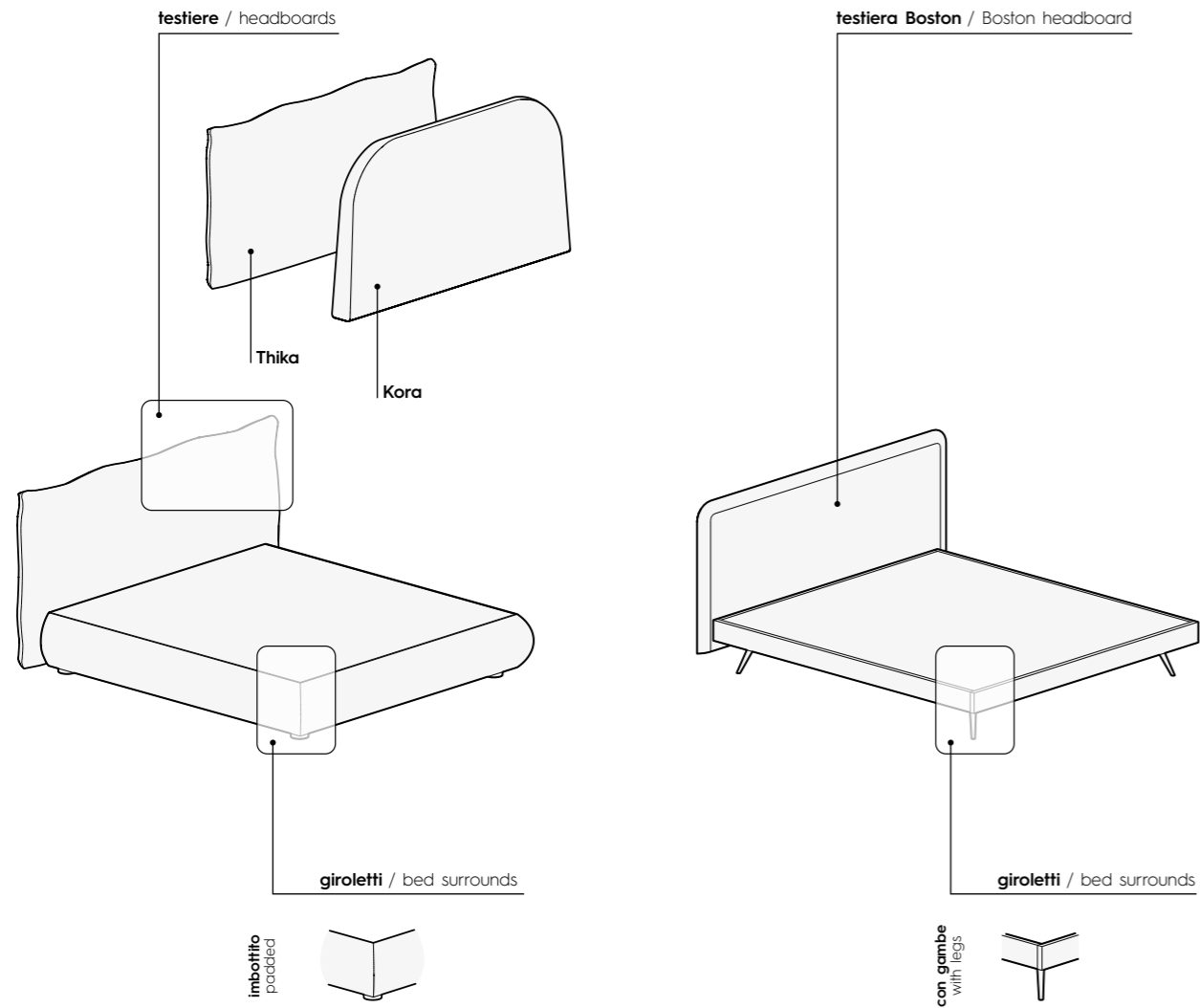

# Turche

## Platform beds

Turca R70 / Platform bed R70

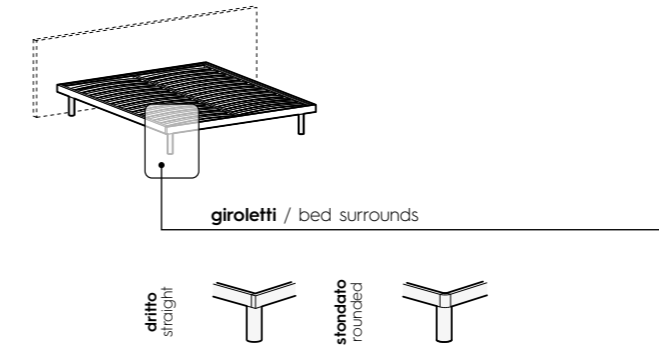

Presente a pag. / Featured on page  
169

Turca R180 / Platform bed R180

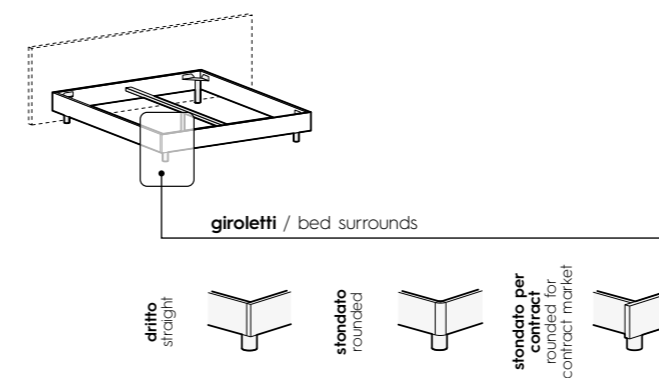

Presente a pag. / Featured on page  
181, 201

Turca R290 / Platform bed R290

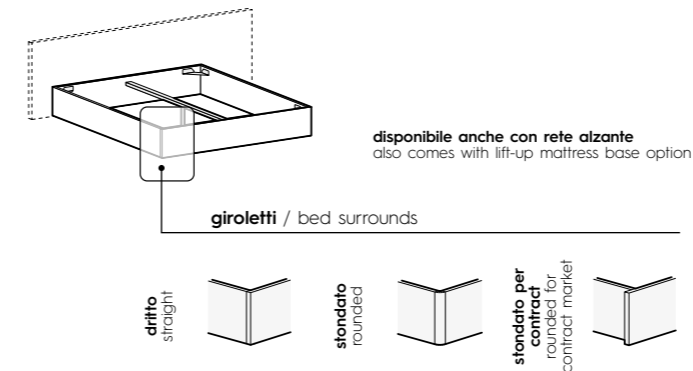

Presente a pag. / Featured on page  
189, 203

Turca R120 / Platform bed R120

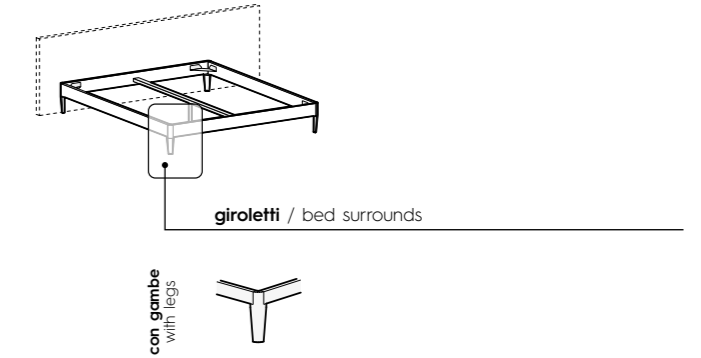

Turca R18Z / Platform bed R18Z

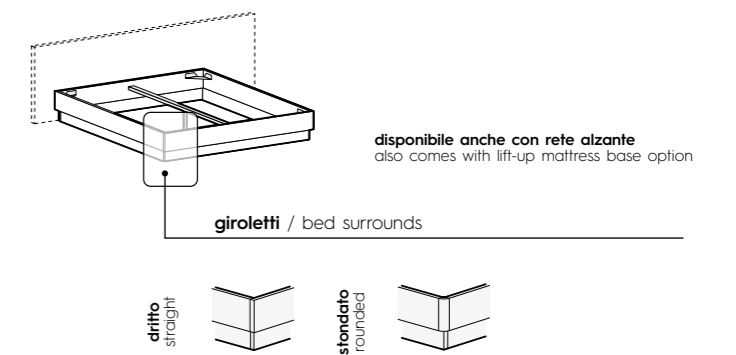

Turca imbottita / Padded platform bed

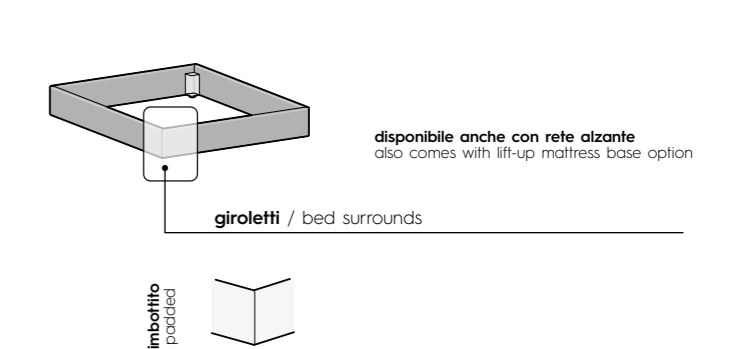

Presente a pag. / Featured on page  
175

# Letti in nobilitato

## Beds in foil-wrapped finish

### Este



**L x P x H / W x D x H**  
128/148/158/168/188 x 206/216/234 x 95/97 cm

**Giroletti / Bed surrounds**  
**tutti i giroletti (escluso imbottito)**  
all bed surrounds (except padded options)

**Finiture / Finishes**  
**finiture basic e smart (escluso finiture materiche su raccordo stondato)**  
basic and smart finishes (except textured finishes on rounded corner piece)

**Immagine: giroletto e finiture**  
Pictured: bed surround and finishes  
**R70 stondato / rounded R70**  
**sabbia / sabbia**

### Mostar



**L x P x H / W x D x H**  
158/168 x 206/216/234 x 95/97 cm

**Giroletti / Bed surrounds**  
**tutti i giroletti (escluso imbottito)**  
all bed surrounds (except padded options)

**Finiture / Finishes**  
**finiture basic e smart (escluso finiture materiche su testiera e raccordo stondato)**  
basic and smart finishes (except textured finishes on headboard and rounded corner piece)

**Immagine: giroletto e finiture**  
Pictured: bed surround and finishes  
**R180 dritto / straight R180**  
**basalto / basalto**

### Lagos



**L x P x H / W x D x H**  
128/158/168/188 x 206/216/234 x 95/97 cm

**Giroletti / Bed surrounds**  
**tutti i giroletti (escluso imbottito)**  
all bed surrounds (except padded options)

**Finiture / Finishes**  
**tutti i tessuti e le finiture basic e smart (escluso finiture materiche su raccordo stondato)**  
all fabrics and basic and smart finishes (except textured finishes on rounded corner piece)

**Immagine: giroletto e finiture**  
Pictured: bed surround and finishes  
**R290 stondato / rounded R290**  
**frassino chiaro, thick T529**  
frassino chiaro, thick T529

### Suez



**L x P x H / W x D x H**  
128/148/158/168/188 x 206/216/234 x 90/92 cm

**Giroletti / Bed surrounds**  
**tutti i giroletti (escluso imbottito)**  
all bed surrounds (except padded options)

**Finiture / Finishes**  
**tutte le finiture basic e smart (escluso finiture materiche su raccordo stondato)**  
all fabrics and basic and smart finishes (except textured finishes on rounded corner piece)

**Immagine: giroletto e finiture**  
Pictured: bed surround and finishes  
**R120 / R120**  
**noce naturale / noce naturale**

**Presente a pag. / Featured on page**  
215



# Letti in nobilitato

## Beds in foil-wrapped finish

### Suez Maxi



**L x P x H / W x D x H**  
128/148/158/168/188 x 206/216/234 x 90/92 cm

**Gioletti / Bed surrounds**  
**tutti i gioletti (escluso imbottito)**  
all bed surrounds (except padded options)

**Finiture / Finishes**  
**finiture basic e smart (escluso finiture materiche su raccordo stondato)**  
basic and smart finishes (except textured finishes on rounded corner piece)

**Immagine: giroletto e finiture**  
Pictured: bed surround and finishes  
**R18Z stondato / rounded R18Z**  
**canapa / canapa**

### Zurigo



**L x P x H / W x D x H**  
158/168 x 206/216/234 x 95/97 cm

**Gioletti / Bed surrounds**  
**tutti i gioletti (escluso imbottito)**  
all bed surrounds (except padded options)

**Finiture / Finishes**  
**finiture basic e smart (escluso finiture materiche su testiera e raccordo stondato)**  
basic and smart finishes (except textured finishes on headboard and rounded corner piece)

**Immagine: giroletto e finiture**  
Pictured: bed surround and finishes  
**R70 dritto / straight R70**  
**cemento / cemento**

### Thun



**L x P x H / W x D x H**  
158/168 x 206/216/234 x 95/97 cm

**Gioletti / Bed surrounds**  
**tutti i gioletti (escluso imbottito)**  
all bed surrounds (except padded options)

**Finiture / Finishes**  
**finiture basic e smart (escluso finiture materiche su testiera e raccordo stondato)**  
basic and smart finishes (except textured finishes on headboard and rounded corner piece)

**Immagine: giroletto e finiture**  
Pictured: bed surround and finishes  
**R180 stondato / rounded R180**  
**rovere cotto, gambe nichel**  
rovere cotto, nichel legs

**Presente a pag. / Featured on page**  
209

# Letti imbottiti

## Padded beds

### Boston



**L x P x H** / W x D x H  
171/191 x 205/215 x 97 cm

**Tessuti** / Fabrics  
**tutti i tessuti** / all fabrics

**Immagine: finiture** / Pictured: finishes  
**spot T543, fettuccia CC14, gambe lavagna**  
spot T543, CC14 piping,  
legs in lavagna

### Isla



**L x P x H** / W x D x H  
128/131/168/171/188/191 x 205/215 x 88/89 cm

**Giroletti** / Bed surrounds  
**imbottito, R18Z dritto e stondato, R290 dritto e stondato**  
padded, straight and rounded R18Z, straight and rounded R290

**Finiture** / Finishes  
**tutti i tessuti e le finiture basic e smart (escluso finiture materiche su raccordo stondato)**  
all fabrics and basic and smart finishes (except textured finishes on rounded corner piece)

**Immagine: giroletto e finiture**  
Pictured: bed surround and finishes  
**R18Z dritto** / straight R18Z  
**calce, cross T512** / calce, cross T512

**Presente a pag.** / Featured on page  
167

### Kora



**L x P x H** / W x D x H  
178/198 x 216/226 x 97 cm

**Tessuti** / Fabrics  
**tutti i tessuti** / all fabrics

**Immagine: tessuti** / Pictured: fabrics  
**soft T568** / soft T568

### Jerez



**L x P x H** / W x D x H  
128/138/168/178/188/198 x 209/213/219/223 x 89/91 cm

**Giroletti** / Bed surrounds  
**imbottito, R18Z dritto e stondato, R290 dritto e stondato**  
padded, straight and rounded R18Z, straight and rounded R290

**Finiture** / Finishes  
**tutti i tessuti e le finiture basic e smart (escluso finiture materiche su raccordo stondato)**  
all fabrics and basic and smart finishes (except textured finishes on rounded corner piece)

**Immagine: giroletto e finiture**  
Pictured: bed surround and finishes  
**R290 stondato** / rounded R290  
**sabbia, thick T530** / sabbia, thick T530

**Presente a pag.** / Featured on page  
183



# Letti imbottiti

## Padded beds

### Thika



**L x P x H / W x D x H**  
178/198 x 218/228 x 94 cm

**Tessuti / Fabrics**  
tutti i tessuti / all fabrics

**Immagine: tessuti / Pictured: fabrics**  
soft T567 / soft T567

### York



**L x P x H / W x D x H**  
168/178/198 x 208/212/218/222 x 92 cm

**Gioielli / Bed surrounds**  
imbottito, R18Z dritto e stondato, R290 dritto e stondato  
padded, straight and rounded R18Z, straight and rounded R290

**Finiture / Finishes**  
tutti i tessuti e le finiture basic e smart (escluso finiture materiche su raccordo stondato)  
all fabrics and basic and smart finishes (except textured finishes on rounded corner piece)

**Immagine: tessuti / Pictured: fabrics**  
cross T515 / cross T515

# Testiere a muro

## Wall-mounted headboards

### Cardiff



**L x P x H / W x D x H**  
0-290/290-580 x 5 x 73/93/113 cm

**Gioielli / Bed surrounds**  
tutte le Turche / all platform beds

**Finiture / Finishes**  
finiture basic e smart  
basic and smart finishes

**Immagine: giroletto e finiture**  
Pictured: bed surround and finishes

**Turca R180 dritto / straight R180 platform bed**  
olmo shade / olmo shade

**Presente a pag. / Featured on page**  
175, 181, 204

**Esempio di composizione fino a L 290 cm**  
Example of configuration up to 290 cm wide



**Immagine: giroletto e finiture / Pictured: bed surround and finishes**  
**Turca R180 dritto / straight R180 platform bed**  
cashmere, basalto / cashmere, basalto

**Esempio con doppia altezza**  
Example with two heights



**Immagine: giroletto e finiture / Pictured: bed surround and finishes**  
**Turca R180 dritto / straight R180 platform bed**  
cemento, spot T544 / cemento, spot T544

**Esempio di composizione oltre L 290 fino a L 580 cm (2 pezzi)**  
Example of configuration over 290 cm wide up to 580 cm wide (2 parts)



**Immagine: giroletto e finiture / Pictured: bed surround and finishes**  
**Turca R180 dritto / straight R180 platform bed**  
rovere cotto / rovere cotto



**Immagine: giroletto e finiture / Pictured: bed surround and finishes**  
**Turca R180 dritto / straight R180 platform bed**  
calce / calce

# Testiere a muro

## Wall-mounted headboards

Arnad



**L x P x H / W x D x H**  
60/90/120 x 2,9 x 36,3/73,2/91,5/109,8 cm

**Gioielli / Bed surrounds**  
**tutte le Turche / all platform beds**

**Finiture / Finishes**  
**tutti i tessuti e le finiture basic e smart**  
all fabrics and basic and smart finishes

**Immagine: giroletto e finiture**  
Pictured: bed surround and finishes  
**Turca imbottita / Padded platform bed**  
**basalto, soft T561 / basalto, soft T561**

**Presente a pag. / Featured on page**  
169, 174, 200

Esempi di composizione / Examples of configuration



**Immagine: giroletto e finiture** / Pictured: bed surround and finishes  
**Turca R70 stonato / rounded R70 platform bed**  
**lavagna, spot T544 / lavagna, spot T544**



**Immagine: giroletto e finiture** / Pictured: bed surround and finishes  
**Turca R70 stonato / rounded R70 platform bed**  
**canapa, thick T530 / canapa, thick T530**



**Immagine: giroletto e finiture** / Pictured: bed surround and finishes  
**Turca R70 stonato / rounded R70 platform bed**  
**noce naturale, cross T500, gambe nuvola**  
noce naturale, cross T500, nuvola legs



**Immagine: giroletto e finiture** / Pictured: bed surround and finishes  
**Turca R70 stonato / rounded R70 platform bed**  
**cemento, smooth T157, gambe nichel**  
cemento, smooth T157, nichel legs



**Immagine: giroletto e finiture** / Pictured: bed surround and finishes  
**Turca R70 stonato / rounded R70 platform bed**  
**olmo shade, cross T502, gambe nuvola**  
olmo shade, cross T502, nuvola legs



**Immagine: giroletto e finiture** / Pictured: bed surround and finishes  
**Turca R70 stonato / rounded R70 platform bed**  
**frassino chiaro, soft T563-568, gambe cashmere**  
frassino chiaro, soft T563-568, cashmere legs



# Librerie con meccanismo ribaltabile

## Bookcases with drop-down mechanism

**Libreria con letto ribaltabile**  
Bookcase with drop-down bed



P / D  
33/43 cm



P / D  
209/219/229 cm

**Libreria** / Bookcase  
L x P x H / W x D x H  
132,6/172,6 x 33/43 x  
203/221,3/239,6/257,9/294,5 cm

**Rete** / Mattress base  
L x P / W x D  
120/160 x 190/200 cm

**Finiture** / Finishes  
**finiture basic e smart**  
basic and smart finishes

**Finiture immagine** / Finishes pictured  
**bianco** / bianco

**Libreria con letto ribaltabile con tavolo**  
Bookcase with drop-down bed with table



P / D  
40/50 cm



P / D  
194/204 cm

**Libreria** / Bookcase  
L x P x H / W x D x H  
172,6 x 33/43 x 221,3/239,6/257,9/294,5 cm

**Finiture** / Finishes  
**finiture basic e smart**  
basic and smart finishes

**Finiture immagine** / Finishes pictured  
**basalto, rovere cotto**  
basalto, rovere cotto

**Libreria con letto ribaltabile, divano e mensola**  
Bookcase with drop-down bed, sofa and shelf



P / D  
112/122 cm



P / D  
209/219/229 cm

**Libreria** / Bookcase  
L x P x H / W x D x H  
172,6 x 33/43 x 221,3/239,6/257,9/294,5 cm

**Rete** / Mattress base  
L x P / W x D  
160 x 190/200 cm

**Finiture** / Finishes  
**tutti i tessuti e le finiture basic e smart**  
all fabrics and basic and smart finishes

**Finiture immagine** / Finishes pictured  
**sabbia, spot T550** / sabbia, spot T550

**Presente a pag.** / Featured on page  
184



P / D  
209/219/229 cm

**Rete** / Mattress base  
L x P / W x D  
160 x 190/200 cm

**Finiture** / Finishes  
**finiture basic e smart**  
basic and smart finishes

**Finiture immagine** / Finishes pictured  
**basalto, rovere cotto**  
basalto, rovere cotto

# Librerie con meccanismo ribaltabile

## Bookcases with drop-down mechanism

### Libreria con letto ribaltabile orizzontale - inferiore

Bookcase with horizontal drop-down bed - bottom section



P / D  
33/43 cm



P / D  
97/107 cm

#### Libreria / Bookcase

L x P x H / W x D x H  
210 x 33/43 x 221,3/239,6/257,9/294,5 cm

#### Rete / Mattress base

L x P / W x D  
80 x 190 cm

#### Finiture / Finishes

**finiture basic e smart**  
basic and smart finishes

#### Finiture immagine / Finishes pictured

**olmo shade** / olmo shade

**Presente a pag.** / Featured on page  
208

### Libreria con doppio letto ribaltabile orizzontale

Bookcase with two horizontal drop-down beds



P / D  
33/43 cm



P / D  
110/120 cm

#### Libreria / Bookcase

L x P x H / W x D x H  
210 x 33/43 x 221,3/239,6/257,9/294,5 cm

#### Rete / Mattress base

L x P / W x D  
80 x 190 cm

#### Finiture / Finishes

**finiture basic e smart**  
basic and smart finishes

#### Finiture immagine / Finishes pictured

**noce naturale, sabbia**  
noce naturale, sabbia

**Presente a pag.** / Featured on page  
191

### Libreria con letto ribaltabile orizzontale - superiore

Bookcase with horizontal drop-down bed - top section



P / D  
33/43 cm

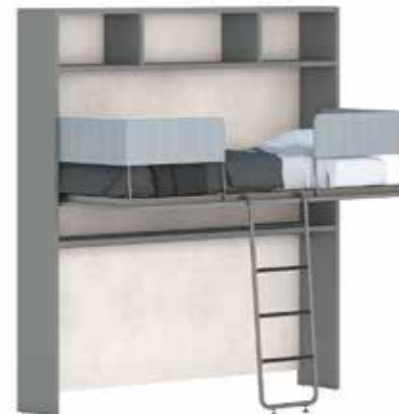

P / D  
110/120 cm

#### Libreria / Bookcase

L x P x H / W x D x H  
210 x 33/43 x 221,3/239,6/257,9/294,5 cm

#### Rete / Mattress base

L x P / W x D  
80 x 190 cm

#### Finiture / Finishes

**finiture basic e smart**  
basic and smart finishes

#### Finiture immagine / Finishes pictured

**cemento, calce** / cemento, calce



# Gruppi letto

## Bedroom units

### Atene



**Finiture / Finishes**  
**finiture basic e smart / basic and smart finishes**  
**Finiture immagine / Finishes pictured**  
**olmo shade / olmo shade**

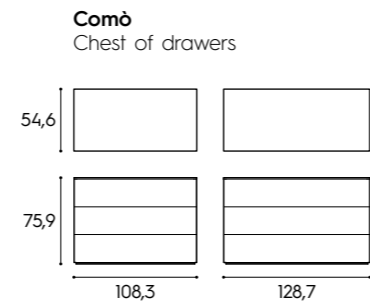
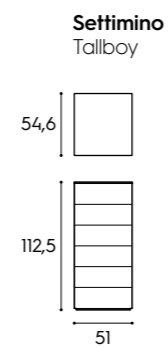
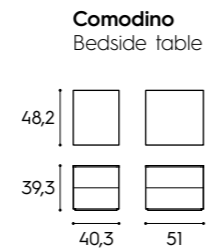

### Bilbao



**Finiture / Finishes**  
**finiture basic e smart / basic and smart finishes**  
**Finiture immagine / Finishes pictured**  
**cemento, frassino chiaro / cemento, frassino chiaro**

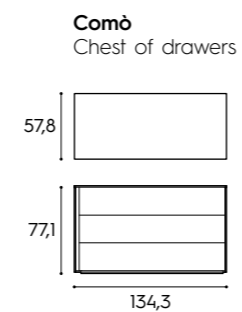
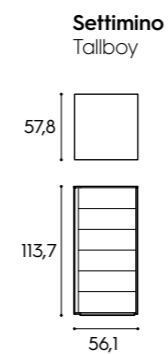
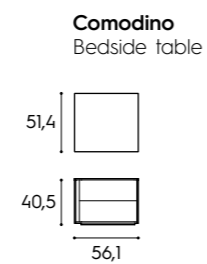

### Bonn



**Finiture / Finishes**  
**finiture basic e smart / basic and smart finishes**  
**Finiture immagine / Finishes pictured**  
**basalto, calce / basalto, calce**

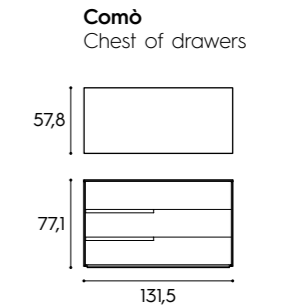
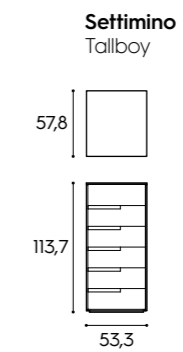
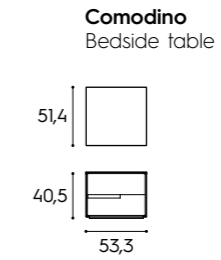

### Londra



**Finiture / Finishes**  
**olmo shade, nuvola, noce naturale, frassino chiaro, rovere cotto**  
**olmo shade, nuvola, noce naturale, frassino chiaro, rovere cotto**  
**Finiture immagine / Finishes pictured**  
**nuvola / nuvola**

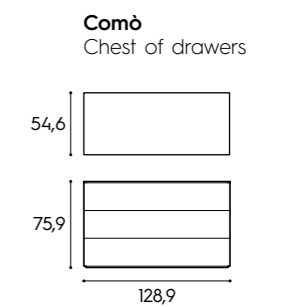
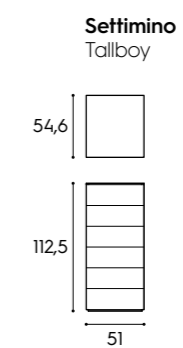
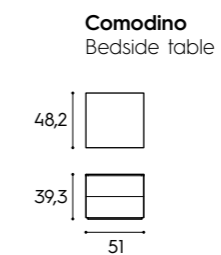

# Gruppi letto

## Bedroom units

### Oslo



#### Finiture / Finishes

**finiture basic e smart** / basic and smart finishes

#### Tutte le maniglie (escluso push-pull)

Any handle options (except push-to-open system)

#### Finiture immagine / Finishes pictured

**rovere cotto, cemento** / rovere cotto, cemento

**Presente a pag.** / Featured on page

167

**Comodino**  
Bedside table

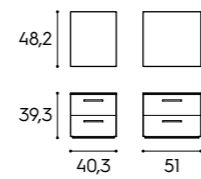

**Settimino**  
Tallboy

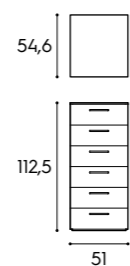

**Comò**  
Chest of drawers

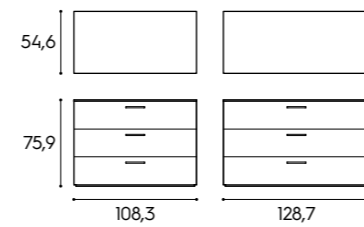

### Parigi



#### Finiture / Finishes

**finiture basic e smart** / basic and smart finishes

#### Finiture immagine / Finishes pictured

**noce naturale, lavagna** / noce naturale, lavagna

**Presente a pag.** / Featured on page

209

**Comodino**  
Bedside table

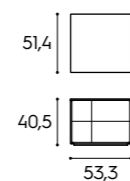

**Settimino**  
Tallboy

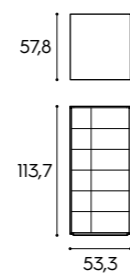

**Comò**  
Chest of drawers

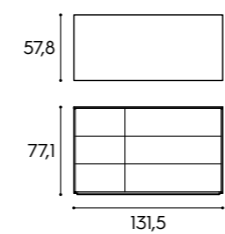

### Praga



#### Finiture / Finishes

**finiture basic e smart (escluso finiture materiche ed ecolegno su gambe)**  
basic and smart finishes (except textured and eco-wood finishes on legs)

#### Tutte le maniglie (escluso push-pull)

Any handle options (except push-to-open system)

#### Finiture immagine / Finishes pictured

**intonaco, cemento** / intonaco, cemento

**Presente a pag.** / Featured on page

215

**Comodino**  
Bedside table

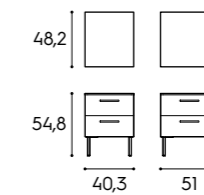

**Settimino**  
Tallboy

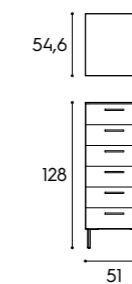

**Comò**  
Chest of drawers



### Tavolino Orig

Orig side table



#### Finiture / Finishes

**finiture basic e smart (escluso finiture materiche ed ecolegno su gambe)**  
basic and smart finishes (except textured and eco-wood finishes on legs)

#### Finiture immagine / Finishes pictured

**cashmere** / cashmere

**Presente a pag.** / Featured on page

114, 133, 189, 203, 219, 254

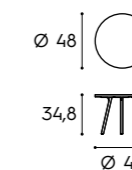



# Scrivanie spessore 3 e 5 cm

## 3 cm- and 5 cm-thick desks

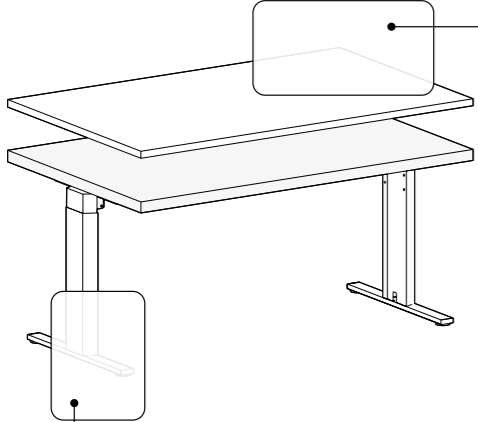

**piano / top**

sp. 3 cm  
3 cm thick

sp. 5 cm  
5 cm thick

**Stondato 2 lati**  
Rounded on 2 sides

**Stondato 4 lati**  
Rounded on 4 sides

**Dritto**  
Straight

**Sagomato**  
Shaped

**Piano sp. 3 cm / 3 cm-thick top**  
finiture basic e smart / basic and smart finishes

**Presente a pag. / Featured on page**  
59, 69, 77, 82, 131, 241, 247

**Piano sp. 5 cm / 5 cm-thick top**  
finiture basic, finiture smart ecolegno / basic finishes, smart eco-wood finishes

**Presente a pag. / Featured on page**  
20, 28, 35, 49, 99, 151, 218, 261, 265, 266

**gambe / legs**

**Prisma**  
Prisma

**Cornice**  
Cornice

**Linea**  
Linea

**Fianco**  
Side panel

**Kike**  
Kike

**H / H**  
65/85 cm

**H / H**  
65/85 cm

**H / H**  
74 cm

**H / H**  
70 cm

**H / H**  
68,5/92,5 cm

**Presente a pag.**  
Featured on page  
69, 99, 247

**Presente a pag.**  
Featured on page  
20, 41

**Presente a pag.**  
Featured on page  
35, 49, 77, 143

**Presente a pag.**  
Featured on page  
69, 278

**Gambe in metallo / Metal legs**  
bianco, lavagna / bianco, lavagna

**Gambe in pannello / Panel legs**  
finiture basic e smart / basic and smart finishes

### Esempi di composizione / Examples of configuration



# Scrivanie dinamiche

## Sit-stand desks

### Scrivanie dinamiche

Sit-stand desks

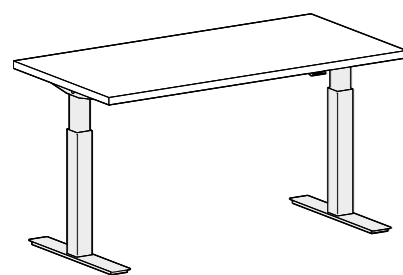

**Piano sp. 3 cm / 3 cm-thick top**  
**finiture basic e smart / basic and smart finishes**

**Gambe in metallo / Metal legs**  
**bianco, lavagna / bianco, lavagna**

**Finiture immagine / Finishes pictured**  
**bianco / bianco**

**Dimensioni / Dimensions**

|              |              |                         |
|--------------|--------------|-------------------------|
| <b>L / W</b> | <b>P / D</b> | <b>H / H</b>            |
| 160/180 cm   | 80/100 cm    | min. 70 cm, max. 116 cm |

**Presente a pag. / Featured on page**  
 111

**Esempi di composizione / Examples of configuration**



**Piano sp. 3 cm / 3 cm-thick top**  
**finiture basic e smart / basic and smart finishes**

**Gambe in metallo / Metal legs**  
**bianco, lavagna / bianco, lavagna**

**Finiture immagine / Finishes pictured**  
**bianco / bianco**

**Dimensioni / Dimensions**

|              |                         |
|--------------|-------------------------|
| <b>L / W</b> | <b>H / H</b>            |
| 130/150 cm   | min. 70 cm, max. 116 cm |

**Presente a pag. / Featured on page**  
 59

**Esempi di composizione / Examples of configuration**



# Scrivtoi per contract

## Desks for contract market

### Scrivtoi con piano in folding h 7 cm (gambe sp. 3 cm)

Desks with h 7 cm mitre-folded top (legs 3 cm thick)

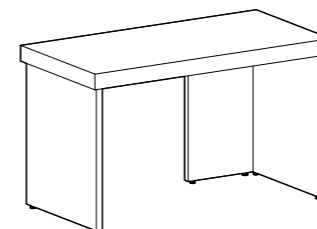

**Finiture / Finishes**

**finiture basic e smart / basic and smart finishes**

**Dimensioni / Dimensions**

|              |              |              |
|--------------|--------------|--------------|
| <b>L / W</b> | <b>P / D</b> | <b>H / H</b> |
| 120 cm       | 60,6 cm      | 72 cm        |

### Scrivtoi e piani di lavoro sp. 3 cm

Desks and worktops 3 cm thick

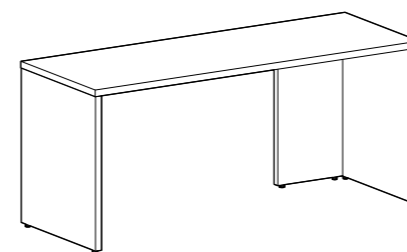

**Finiture / Finishes**

**finiture basic e smart / basic and smart finishes**

**Dimensioni / Dimensions**

|              |              |              |
|--------------|--------------|--------------|
| <b>L / W</b> | <b>P / D</b> | <b>H / H</b> |
| 165 cm       | 45,8/60,6 cm | 73 cm        |
| 165 cm       | 70 cm        | 96,2 cm      |

### Scrivtoi sp. 3 cm con vano per frigo

Desks 3 cm thick with mini-bar cabinet

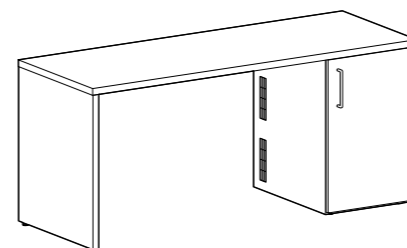

**Finiture / Finishes**

**finiture basic e smart / basic and smart finishes**

**Dimensioni / Dimensions**

|              |              |              |
|--------------|--------------|--------------|
| <b>L / W</b> | <b>P / D</b> | <b>H / H</b> |
| 165 cm       | 60,6 cm      | 73 cm        |

**Presente a pag. / Featured on page**  
 165, 179



# Piani sospesi con alzata

## Wall-mounted tops with upstand

**Piani sospesi con alzata**  
Wall-mounted tops with upstand

**Piano disponibile / Top options**



**Stondato 2 lati**  
Rounded on 2 sides



**Stondato 1 lato**  
Rounded on 1 side



**Dritto**  
Straight

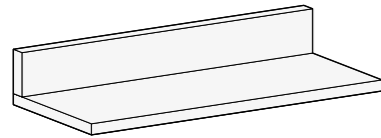

**Piano sp. 5 cm / 5 cm-thick top**  
**finiture basic, finiture smart ecolegno** / basic finishes, smart eco-wood finishes

**Dimensioni / Dimensions**

|                    |                 |              |
|--------------------|-----------------|--------------|
| <b>L / W</b>       | <b>P / D</b>    | <b>H / H</b> |
| 120/135/150/180 cm | 35,8/45,8/61 cm | 18,3 cm      |

**Presente a pag. / Featured on page**  
128, 203

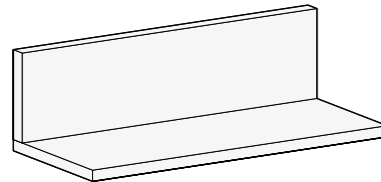

**Piano sp. 5 cm / 5 cm-thick top**  
**finiture basic, finiture smart ecolegno** / basic finishes, smart eco-wood finishes

**Dimensioni / Dimensions**

|                    |                 |              |
|--------------------|-----------------|--------------|
| <b>L / W</b>       | <b>P / D</b>    | <b>H / H</b> |
| 120/135/150/180 cm | 35,8/45,8/61 cm | 36,6 cm      |

**Presente a pag. / Featured on page**  
49, 103, 154, 172, 275

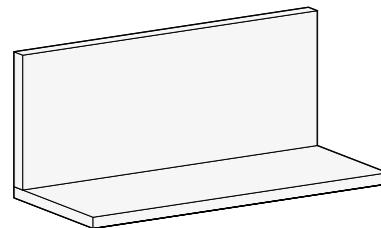

**Piano sp. 5 cm / 5 cm-thick top**  
**finiture basic, finiture smart ecolegno** / basic finishes, smart eco-wood finishes

**Dimensioni / Dimensions**

|                    |                 |              |
|--------------------|-----------------|--------------|
| <b>L / W</b>       | <b>P / D</b>    | <b>H / H</b> |
| 120/135/150/180 cm | 35,8/45,8/61 cm | 54,9 cm      |

**Esempi di composizione / Examples of configuration**



# Scrivanie spessore 1,2 cm

## 1,2 cm-thick desks

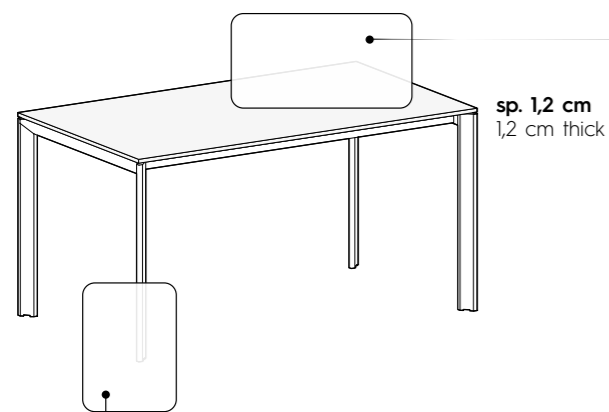

piano / top

sp. 1,2 cm  
1,2 cm thick

**Piano nobilitato sp. 1,2 cm / 1,2 cm-thick foil-wrapped top**  
**finiture basic e smart / basic and smart finishes**



**L x P / W x D**  
120/140/160/180/200/250 x  
60/80/100/120 cm

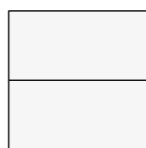

**Doppio / Double**

**L x P / W x D**  
120/140/160/180/200/250 x 165 cm

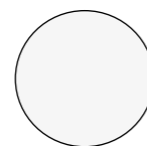

**Circolare / Circular**

**Ø**  
125/145 cm

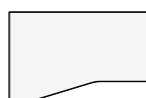

**Sagomato / Shaped**

**L x P / W x D**  
160/180 x 80/100 - 80/120 cm

**Piano in vetro sp. 1,2 cm / 1,2 cm-thick glass top**

**bianco / white**

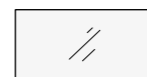

**L x P / W x D**  
120/140/160/180 x 60 cm  
120/140/160/180/200 x 80 cm  
120/180/200 x 100/120 cm

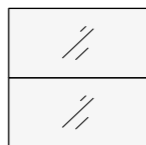

**Doppio / Double**

**L x P / W x D**  
120/140/160/180/200 x 165 cm

**Presente a pag. / Featured on page**

20, 25, 37, 38, 54, 65, 72, 87, 90, 103, 105, 112, 117, 123, 127, 131, 139, 227, 231, 247, 258, 277

**gambe / legs**

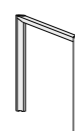

**H / H**  
73,8 cm

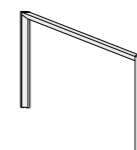

**H / H**  
73,8 cm



**H / H**  
73,8 cm



**H / H**  
13,3/15,1 cm



**H / H**  
73,8 cm

Esempi di composizione / Examples of configuration





# Tavoli

## Tables

### Lione Small

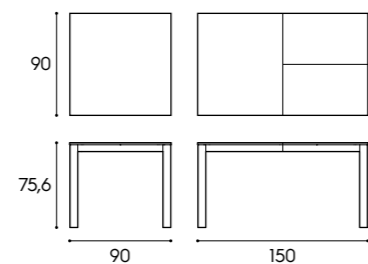

**Piano sp. 1,8 cm / 1,8 cm-thick top**  
**finiture basic e smart / basic and smart finishes**

**Gambe in metallo / Metal legs**  
**bianco, lavagna / bianco, lavagna**

**Finiture immagine / Finishes pictured**  
**bianco / bianco**

### Lione Large

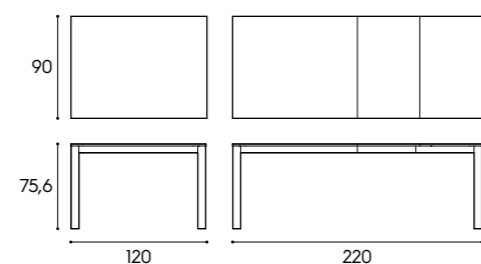

**Piano sp. 1,8 cm / 1,8 cm-thick top**  
**finiture basic e smart / basic and smart finishes**

**Gambe in metallo / Metal legs**  
**bianco, lavagna / bianco, lavagna**

**Finiture immagine / Finishes pictured**  
**bianco / bianco**

### Corby

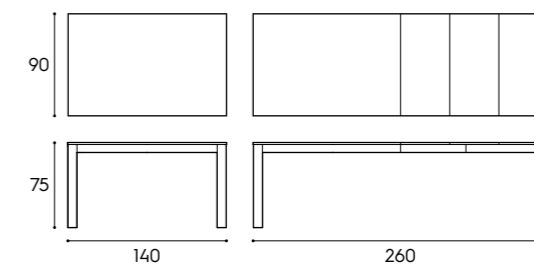

**Piano sp. 1,8 cm / 1,8 cm-thick top**  
**finiture basic e smart / basic and smart finishes**

**Gambe in metallo / Metal legs**  
**bianco, lavagna / bianco, lavagna**

**Finiture immagine / Finishes pictured**  
**bianco / bianco**

**Presente a pag. / Featured on page**  
**283**

### Corby penisola

Corby peninsula

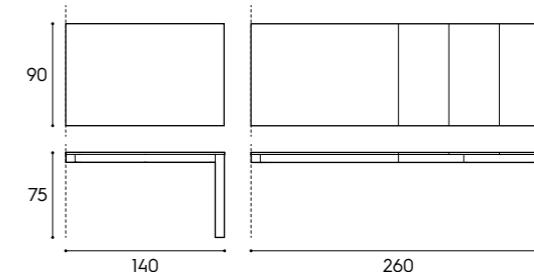
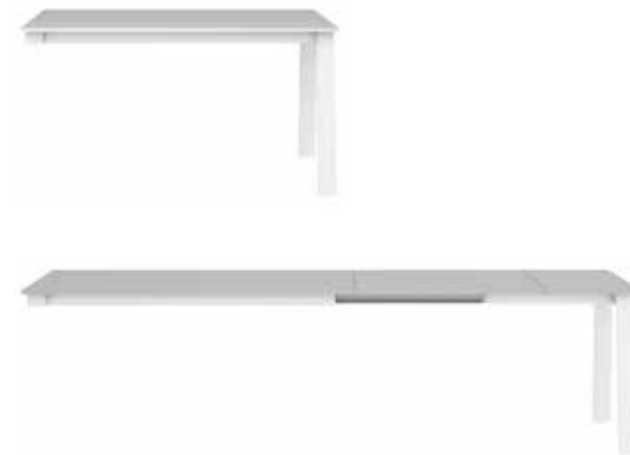

**Piano sp. 1,8 cm / 1,8 cm-thick top**  
**finiture basic e smart / basic and smart finishes**

**Gambe in metallo / Metal legs**  
**bianco, lavagna / bianco, lavagna**

**Finiture immagine / Finishes pictured**  
**bianco / bianco**

# Tavoli

## Tables

### Nizza Small

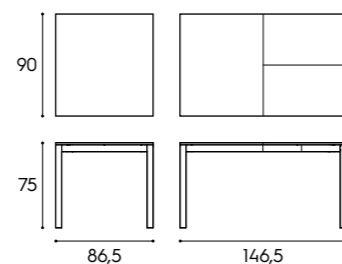

**Piano sp. 1,8 cm** / 1,8 cm-thick top  
**finiture basic e smart** / basic and smart finishes

**Gambe in metallo** / Metal legs  
**bianco, lavagna** / bianco, lavagna

**Finiture immagine** / Finishes pictured  
**bianco** / bianco

### Nizza Large

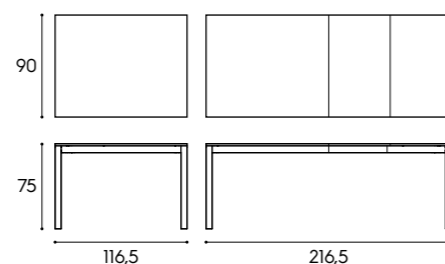

**Piano sp. 1,8 cm** / 1,8 cm-thick top  
**finiture basic e smart** / basic and smart finishes

**Gambe in metallo** / Metal legs  
**bianco, lavagna** / bianco, lavagna

**Finiture immagine** / Finishes pictured  
**bianco** / bianco

### Monaco

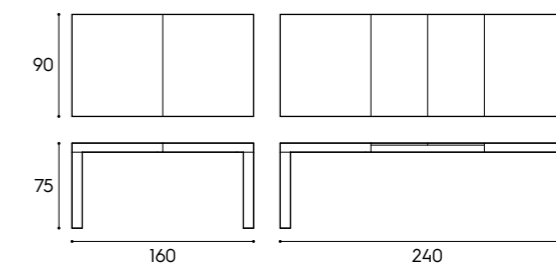

**Finiture** / Finishes  
**calce, intonaco** / calce, intonaco

**Finiture immagine** / Finishes pictured  
**calce** / calce

**Presente a pag.** / Featured on page  
 213

### Vigo

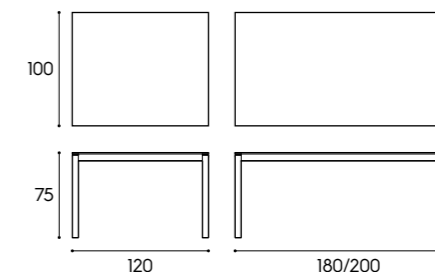

**Piano sp. 1,2 cm** / 1,2 cm-thick top  
**vetro bianco** / white glass

**Gambe in metallo** / Metal legs  
**bianco, lavagna** / bianco, lavagna

**Finiture immagine** / Finishes pictured  
**bianco, vetro bianco** / bianco, white glass



# Tavoli

## Tables

### Richiudibile

Folding

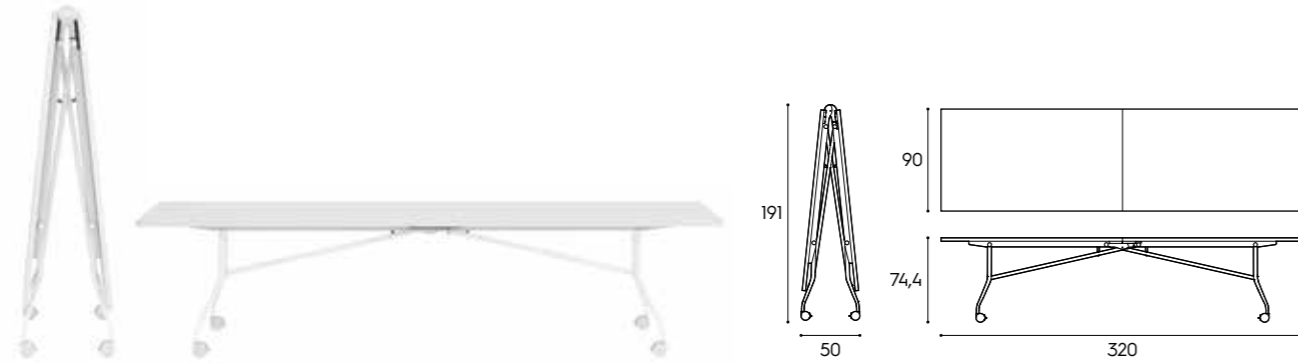

**Piano sp. 3 cm / 3 cm-thick top**  
**finiture basic e smart / basic and smart finishes**

**Gambe in metallo / Metal legs**  
**bianco, lavagna / bianco, lavagna**

**Finiture immagine / Finishes pictured**  
**bianco / bianco**

**Presente a pag. / Featured on page**  
 137

### Ribaltabile

Drop-down

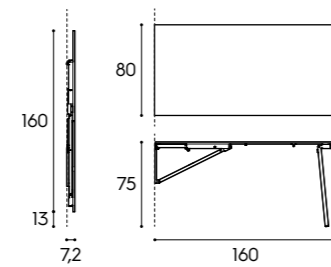

**Piano sp. 1,8 cm / 1,8 cm-thick top**  
**finiture basic e smart / basic and smart finishes**

**Gambe in metallo / Metal legs**

**Finiture immagine / Finishes pictured**  
**bianco / bianco**

**Presente a pag. / Featured on page**  
 201

# Tavolini

## Occasional tables

### Anversa

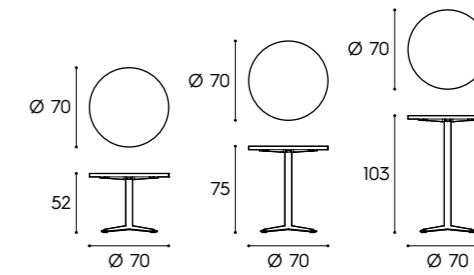

**Piano sp. 1,8 cm / 1,8 cm-thick top**  
**finiture basic e smart / basic and smart finishes**

**Gambe in metallo / Metal legs**  
**bianco, nero / bianco, nero**

**Finiture immagine / Finishes pictured**  
**bianco / bianco**

**Presente a pag. / Featured on page**  
 125, 128, 149, 157, 232, 275

# Sedie Chairs

Giant



**Sedia in tecnopolimero**  
Technopolymer chair  
J00, J21, J54 / J00, J21, J54

**Finiture immagine** / Finishes pictured  
J54 / J54

**Presente a pag.** / Featured on page  
52, 149, 213, 283

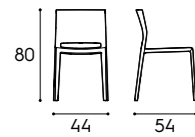

Cork



**Sedia in tecnopolimero**  
Technopolymer chair  
J00 / J00

**Finiture immagine** / Finishes pictured  
J00 / J00

**Presente a pag.** / Featured on page  
278

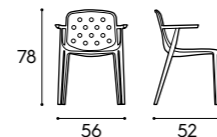

# Sedie imbottite Upholstered chairs

Sneek



**Seduta imbottita** / Upholstered chair  
tutti i tessuti e feltro  
all fabrics and felt

**Basamento R1 in metallo**  
Metal R1 base  
bianco / white

**Finiture immagine** / Finishes pictured  
smooth T175, bianco / smooth T175, white

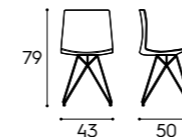

Sneek



**Seduta imbottita** / Upholstered chair  
tutti i tessuti e feltro  
all fabrics and felt

**Basamento R2 in metallo**  
Metal R2 base  
bianco, nero / white, black

**Finiture immagine** / Finishes pictured  
feltro TF23, bianco / felt TF23, white

**Presente a pag.** / Featured on page  
31, 65, 165, 178

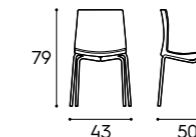

Sneek



**Seduta in tecnopolimero**  
Technopolymer seat  
J00, J10, J23, J36 / J00, J10, J23, J36

**Basamento R1 in metallo**  
Metal R1 base  
bianco / white

**Finiture immagine** / Finishes pictured  
J00 / J00

**Presente a pag.** / Featured on page  
35, 49

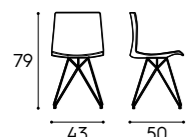

Sneek



**Seduta in tecnopolimero**  
Technopolymer seat  
J00, J10, J23, J36 / J00, J10, J23, J36

**Basamento R2 in metallo**  
Metal R2 base  
bianco, nero / white, black

**Finiture immagine** / Finishes pictured  
J10, nero / J10, black

**Presente a pag.** / Featured on page  
137, 275

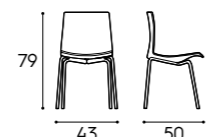

Nerja



**Seduta in ecopelle e gambe in metallo**  
Imitation leather seat and metal legs  
bianco, testa di moro / white, dark brown

**Finiture immagine** / Finishes pictured  
testa di moro / dark brown

**Presente a pag.** / Featured on page  
170

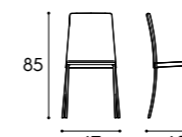



# Sedie su ruote

## Swivel chairs

### Assen



**Struttura / Frame**  
in nylon e rete / in nylon and mesh  
nero / black

**Seduta imbottita / Padded seat**  
tessuti per sedie su ruote  
swivel chair fabrics

**Basamento a 5 razze girevole**  
5-star swivel base  
nero, cromato / black, chrome

**Finiture immagine / Finishes pictured**  
TL32, nero / TL32, black

**Presente a pag. / Featured on page**  
65, 113

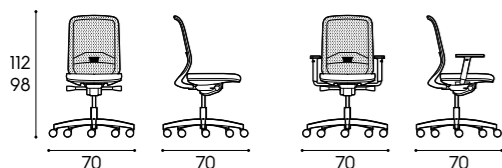

### York



**Struttura / Frame**  
in polipropilene e rete o polipropilene  
in polypropylene and mesh  
or polypropylene  
nero / black

**Seduta imbottita / Padded seat**  
tessuti per sedie su ruote  
swivel chair fabrics

**Basamento a 5 razze girevole**  
5-star swivel base  
nero, cromato / black, chrome

**Finiture immagine / Finishes pictured**  
TL32, nero / TL32, black

**Presente a pag. / Featured on page**  
37, 49, 73, 91, 99

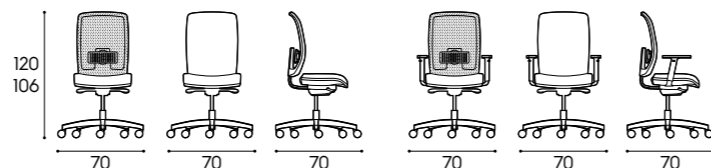

### Basilea



**Struttura / Frame**  
in tecnopolimero / in technopolymer  
nero / black

**Sedia imbottita / Padded chair**  
tessuti per sedie su ruote  
swivel chair fabrics

**Basamento a 5 razze girevole**  
5-star swivel base  
nero, cromato / black, chrome

**Finiture immagine / Finishes pictured**  
TL32, nero / TL32, black

**Presente a pag. / Featured on page**  
29, 53, 105, 122, 227

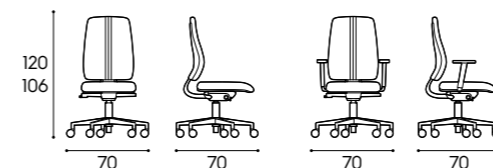

### Montreal



**Struttura / Frame**  
in polipropilene / in polypropylene  
nero / black

**Sedia imbottita / Padded chair**  
tessuti per sedie su ruote  
swivel chair fabrics

**Basamento a 5 razze girevole**  
5-star swivel base  
nero, cromato / black, chrome

**Finiture immagine / Finishes pictured**  
TL32, nero / TL32, black

**Presente a pag. / Featured on page**  
20, 25, 35

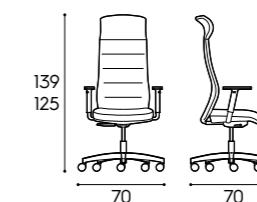

### Sofa



**Struttura / Frame**  
in tecnopolimero e rete  
in technopolymer and mesh  
nero / black

**Seduta imbottita / Padded seat**  
tessuti per sedie su ruote  
swivel chair fabrics

**Basamento a 5 razze girevole**  
5-star swivel base  
nero, cromato / black, chrome

**Finiture immagine / Finishes pictured**  
TL32, nero / TL32, black

**Presente a pag. / Featured on page**  
69, 83, 231

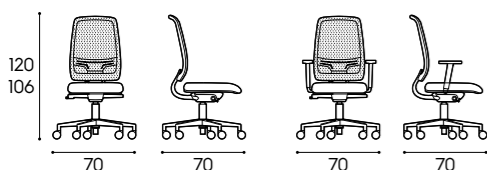

### Laki



**Struttura / Frame**  
in tecnopolimero / in technopolymer  
nero / black

**Sedia imbottita / Padded chair**  
TL30 e TL32 / TL30 and TL32

**Basamento a 5 razze girevole**  
5-star swivel base  
nero / black

**Finiture immagine / Finishes pictured**  
TL32, nero / TL32, black

**Presente a pag. / Featured on page**  
40, 77, 87, 130

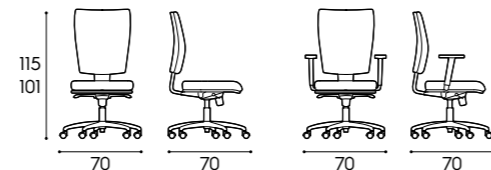

### Nice



**Sedia imbottita / Padded chair**  
tessuti per sedie su ruote  
swivel chair fabrics

**Basamento a 5 razze girevole**  
5-star swivel base  
cromato / chrome

**Finiture immagine / Finishes pictured**  
TL32, cromato / TL32, chrome

**Presente a pag. / Featured on page**  
20, 43, 117, 142

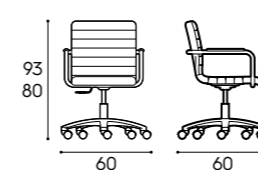

### Cannes



**Sedia imbottita / Padded chair**  
tessuti per sedie su ruote  
swivel chair fabrics

**Basamento a 4 razze girevole**  
4-star swivel base  
nero / black

**Finiture immagine / Finishes pictured**  
TL32, nero / TL32, black

**Presente a pag. / Featured on page**  
25, 38, 103, 139, 201

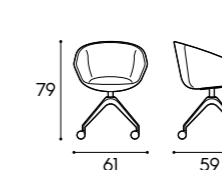

# Sgabelli Stools

## Sneek



**Seduta / Seat**  
in tecnopolimero / in technopolymer  
J00, J10, J23, J36  
J00, J10, J23, J36

**Basamento in metallo**  
Metal base  
bianco, nero / white, black

**Finiture immagine / Finishes pictured**  
J00, bianco / J00, white

**Presente a pag. / Featured on page**  
103, 128, 154, 203, 219, 275, 280

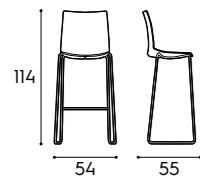

## Helsinki



**Struttura / Frame**  
in tecnopolimero / in technopolymer  
nero / black

**Sedia imbottita / Padded chair**  
tessuti per sedie su ruote  
swivel chair fabrics

**Basamento girevole a 5 razze con poggiatesta**  
5-star swivel base with footrest  
nero / black

**Finiture immagine / Finishes pictured**  
TL31 / TL31

**Presente a pag. / Featured on page**  
59, 111, 247

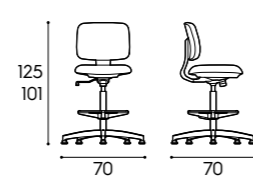

# Lounge e Pouf Lounger chair and Ottoman

## Sneek lounge / lounge chair



**Sedia imbottita / Padded chair**  
tessuti per sedie su ruote e feltro  
swivel chair fabrics and felt

**Basamento in metallo**  
Metal base  
bianco, nero / white, black

**Finiture immagine / Finishes pictured**  
spot T544, nero / spot T544, black

**Presente a pag. / Featured on page**  
114, 125, 128, 232, 254

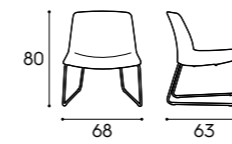

## Tokyo pouf / ottoman



**Struttura / Frame**  
in tecnopolimero / in technopolymer  
nero / black

**Finiture immagine / Finishes pictured**  
TL36 / TL36

**Presente a pag. / Featured on page**  
172, 187, 193, 199, 217

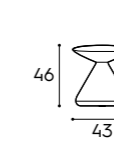

## Harlem



**Struttura / Frame**  
in tecnopolimero / in technopolymer  
nero / black

**Seduta imbottita / Padded seat**  
tessuti per sedie su ruote  
swivel chair fabrics

**Finiture immagine / Finishes pictured**  
TL30 / TL30

**Presente a pag. / Featured on page**  
151, 283

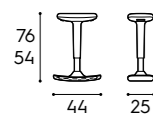



# Divano

## Sofa

### Madrid



**Divano imbottito** / Upholstered sofa

**tutti i tessuti** / all fabrics

**Bordo in contrasto nei colori fettuccia**  
(non disponibile per ecopelle Smooth)

Contrasting piping in any of the piping fabric colours  
(not an option for Smooth imitation leather)

**Immagine: tessuti** / Pictured: fabrics

**spot T542, cenere** / spot T542, cenere

**Presente a pag.** / Featured on page

27, 34, 100, 109, 125, 133, 157, 219, 228, 231, 248, 265

### Elemento centrale / Central section

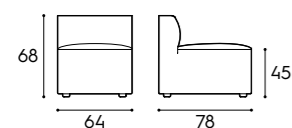

### Elemento laterale o ad angolo / Side or corner section

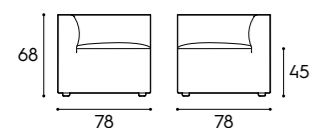

### Pouf / Ottoman

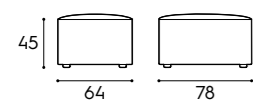

### Esempi di composizione / Examples of configuration



**Immagine: tessuti** / Pictured: fabrics

**cross T512** / cross T512

**CC11** / CC11



**Immagine: tessuti** / Pictured: fabrics

**soft T563** / soft T563

**CC13** / CC13

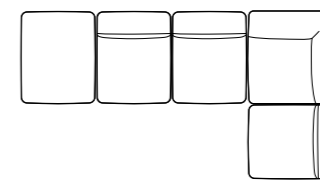

**Immagine: tessuti** / Pictured: fabrics

**thick T522** / thick T522

**CC10** / CC10

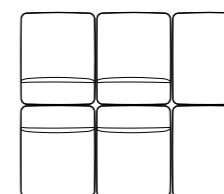

**Immagine: tessuti** / Pictured: fabrics

**smooth T152** / smooth T152

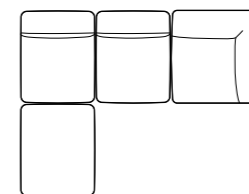

# Accessori elettrici

## Electrical accessories

**Strip LED per fianchi Uniko**  
LED strip for Uniko sides



**Retroilluminazione a LED per testiera Arnad**  
LED backlighting for Arnad headboard

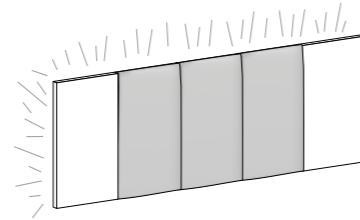

**Lampada LED esterna**  
Surface-mounted LED light



**Finitura / Finish**  
**brunito / bronze**

**Ricarica wireless sottopiano**  
Undermounted wireless charging

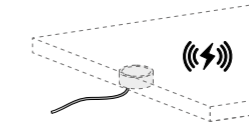

**Luce LED verticale per cabina armadio e a spalla**  
Vertical LED light for walk-in closet and walk-in closet with load-bearing side panels

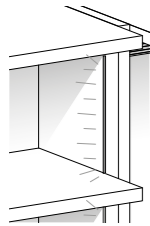

**LED direzionale per testiera Cardiff**  
Directional LED for Cardiff headboard

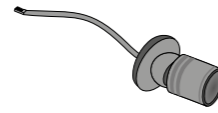

**Finitura in metallo / Metal finish**  
**brunito / bronze**

**Kit faretti LED esterni**  
Surface-mounted LED spotlight kit



**Finitura / Finish**  
**metacrilato / methacrylate**

**Presina da incasso**  
Flush socket

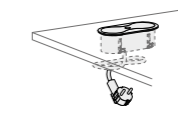

**Finitura in metallo / Metal finish**  
**brunito / bronze**



**chiusa / closed**



**aperta / open**

**Luce LED verticale per armadio e cabina armadio**  
Vertical LED light for wardrobe and walk-in closet

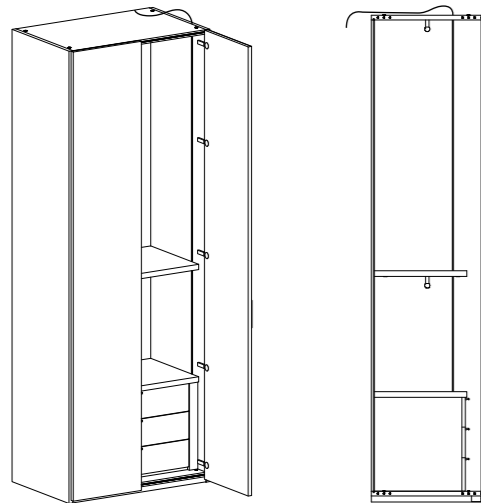

**Strip LED adesiva**  
Adhesive LED strip

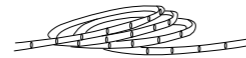

**Consumo singolo / Wattage per light**  
10 W/m 24 V

**Adeguabile a misura**  
Can be adjusted to size

**Lampada LED a batterie ricaricabili**  
LED light with rechargeable batteries

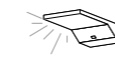

**Finiture / Finishes**  
**bianco, lavagna / bianco, lavagna**

**Luce / Light**  
**warm white / warm white**



## Credits

creative and design director

**Valeria Carlesso**

communication concept and graphic design

**grucciadesign.**

project and set design

**cinquanta3 studio**

digital images

**Helios Digital**

colour separation and print

**Lucegroup**

March 2022

## Cinquanta3

via G. Galilei 35  
31053 Pieve di Soligo  
Treviso - Italia

T +39 0438 83 93  
F +39 0438 83 95 55  
info@cinquanta3.it  
cinquanta3.it

**Battistella spa si riserva in qualsiasi momento la facoltà di apportare tutte le modifiche necessarie al miglioramento funzionale e qualitativo dei propri prodotti. Per ogni aspetto tecnico e dimensionale fare riferimento ai listini aziendali e relativi aggiornamenti. I colori e i materiali riprodotti nelle immagini stampate hanno un valore indicativo. Battistella spa declina ogni responsabilità derivante da eventuali inesattezze di stampa e/o da errori sulle caratteristiche dei prodotti forniti.**

In line with its policy of improving product function and quality, Battistella spa reserves the right to make any necessary changes at any time. For information of a technical and dimensional nature, refer to the company price lists and relevant updates. The colours and materials reproduced in the images printed herein are given as an approximate guide only. Battistella spa does not accept any responsibility for misprints and/or mistakes in describing the characteristics of the products supplied.



