

WIENER

---

•GIV•

---

DESIGN

# INDEX

History	13
Timeless Authenticity	28
The Green Challenge	30
The Technique Of Wood Bending	32
Designers	34
Friedberg Thonet Museum	36
Collections	37
Abacus	300

CHAIRS &  
ARMCHAIRS



**Ample**  
40 (236, 293)



**Beaulieu**  
46 (232, 238)



**Bistrotstuhl**  
50



**Bodystuhl**  
52 (299)



**Brezel**  
56



**Caféstuhl**  
58



**Czech**  
60 (230)



**Czech**  
60 (230)



**Gustav**  
68



**Hagu**  
70 (292)



**Loop Dining Chair**  
154



**Loos Café Museum**  
74



**Magistretti 0301**  
76 (245)



**Malit**  
78 (221, 247)



**Morris**  
80 (229)



**Morris**  
80 (229)



**N. 0**  
82



**N. 1**  
86 (123)





**N. 14**

**88** (249)



**N. 18**

**90** (243)



**N. 811**

**92** (248)



**Pince**

**98**



**Post Mundus**

**100**



**Postsparkasse**

**102** (226)



**Radetzky**

**104** (222)



**Sölden**

**106** (246)



**Sugiloo**

**110** (224, 244, 297)



**Vienna 144**

**114**



**Wiener Stuhl**

**116** (220, 234)

**STOOLS**



**Cirque**

**120**



**N. 18**

**90**



**N. 811**

**92** (242, 296)



**Postsparkasse**

**102** (220, 226)



**Single Curve**

**124** (290)



**Single Curve**

124 (290)



**Trio**

130 (150, 162, 181, 186, 269, 284)



**Trio**

130 (150, 162, 181, 186, 269, 284)



**Vienna 144**

132 (238)



**BENCHES**



**Coat Rack Bench**

122 (218)



**Mos Bench**

192 (139, 171, 214)

**LOUNGE  
CHAIRS  
& SOFAS**



**Chignon**

134



**Hideout**

136



**Jannis**

142 (201)



**Lehnstuhl**

146 (202)



**Loie**

150 (143)



Loop Lounge and Banquette

154



Luftballon

162 (256, 275, 294)



Mickey

168



N. 200

170 (184, 211, 215, 261)



Promenade

174 (258)



Promenade

174 (258)



Schaukelstuhl

178



Suzenne

180



Targa

184 (170, 266)

STORAGE  
UNITS AND  
BOOKCASES



Mos Bookcase, Cabinet, Console

190 (298)



**NYNY**  
200

**HEADBOARDS**



**OttoW**  
210



**Rue**  
214 (264)

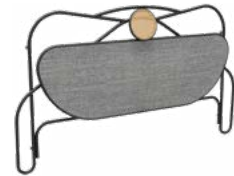

**Yvette**  
218

**DINING TABLES**



**Arch Dining Table**  
220 (55, 68, 75, 78, 295)



**Caryllon Dining Table**  
222



**Magistretti 0302**  
76 (57)



**Ring Dining Table**  
230 (58, 67, 90)



**Säule**  
232 (40, 54, 92, 110, 154, 292)



**Rehbeintisch**  
226 (66, 89, 156)

**BISTROT TABLES**



**Brandy**  
335



**Cognac**  
242



**Gin**  
243



Pastis

244 (74)



Porto

245 (43, 50, 77, 118, 158)



Rum

246 (79, 106, 108)



Sherry

247



Vermouth

248

COFFEE TABLES



Arch Coffee Table

252 (147, 164, 178, 188, 210)



Detour

254 (142)



Duet

258 (175, 187)



Mos Side Table

192



Peers

260 (180, 183)



Single Curve Low Tables

124 (144, 166, 172, 184, 214)



Wiener Box

264

DESK



Wiener Box

264



Allegory Desk

268 (215)



## ACCESSORIES



Arcadia  
270 (163)



Arch Clothes Valet  
287



Cloud  
272



Eyeshine Mirrors  
273 (218, 284)



Feng  
274



Furia  
278



Kleiderständer  
280



Kleiderständer P29  
281



Kolo Moser  
282



Ladder  
284 (121)



Majordomo  
286



Stocksessel  
288



Waltz  
290

## RUGS



Around Colors  
Rugs Collection  
296

## LAMPS



Tipi  
292 (40, 143)



Wagasa  
294 (145, 151, 163, 188, 202)



## HISTORY

Michael Thonet (1796-1871) and his five children were the most successful manufacturers of furniture in the Industrial Age. Having been invited to develop a patent in Austria by Chancellor Metternich, who had seen his products at the Exhibition held by the society of friends of arts in Koblenz, in 1842, Michael Thonet left Boppard in Germany, to settle in Vienna, where in 1853 he founded the company "Gebrüder Thonet" by involving his five sons. In the Hapsburg capital, Michael Thonet abandoned the more traditional technique of glued lamellar wood in favour of the industrial chemical - mechanical steam bent process. This innovation led him to begin producing wooden furniture, presenting a collection of elegant, yet practical designs that could be manufactured on a larger scale. He immediately supported this with a distribution and sales network that was capable of penetrating any market. It

was during this time that products such as chair No. 1 designed for the famous Viennese Palais Schwarzenberg made their début, gaining fame as 'typically' Thonet, and from which many other models were then designed, up to and including the classic chair No. 14. The company's use of high technology and production techniques, together with widespread fame and a growing reputation, encouraged the most important Viennese architects to design new products. Otto Wagner commissioned the furnishing of the Post Sparkasse. Adolf Loos designed the chair for the Café Museum, in 1895 writing: "When I was in America, I realised that the Thonet chair was the most modern seating available". In 1911, the Gebrüder Thonet catalogue boasted 980 different models. By the end of the second world war, independent production plants had been set up in various different countries and developed into separate businesses.



HENRI DE TOULOUSE-LAUTREC. FASHIONABLE PEOPLE AT LES AMBASSADEURS (AUX AMBASSADEURS: GENS CHIC).  
Dated: 1893. Dimensions: overall: 84.3 x 65.5 cm (33 3/16 x 25 13/16 in.). Oil l'essence over black chalk on wove paper, mounted on cardboard.  
Washington DC, National Gallery of Art. © 2018. Album/Scala, Firenze

In Austria, the home market of Gebrüder Thonet, the business was rebuilt by descendants of Michael Thonet, including his great-grandson Fritz Jakob Thonet as well as Fritz Jakob's children Evamarie Thonet and Richard Thonet. After the war, they had to start from scratch, with little more than their experience and passion for furniture. They recommenced their business in one of Gebrüder Thonet's former warehouses in Vienna. From 1948 on they rented a production site in Rohrau, Steiermark, before they finally built their own production site in Friedberg in 1962. In 1976 the Austrian business changed its name from Gebrüder Thonet to its current name Gebrüder Thonet Vienna. More recently, Gebrüder Thonet Vienna GmbH (GTV) has developed its work in a successful blend of the traditional and the modern, of continuity and renewal, with a new production program that begins by re-editing a series of Gebrüder

Thonet classics.

At the same time, GTV stands for contemporary furnishing. Advanced production techniques are applied to innovative designs and uses of materials, to create highly sought-after, multipurpose furnishing items. Truly original, up-to-date solutions that integrate well with the more classic products of its catalogue, now reworked. Items such as chair No. 14, of which more than 50 million were made between 1850 and 1930, have gone down in history for their fine design and manufacturing quality, and yet still today excite and attract new generations. GTV always succeeds in finding the perfect combination of tradition and innovation, assisted by continuous research into new, clear-cut, versatile designs. GTV is open and looking to the future, without, however, leaving the values and experience of the past behind. This collection is a true reflection of the evolution of our times.



Claudia Cardinale and Alberto Sordi in "A girl in Australia" (Ronald Grant Archive / Mary Evans)

## GESCHICHTE

Michael Thonet (1796-1871) und seine fünf Söhne waren die erfolgreichsten Möbelhersteller des Industriezeitalters. Auf Einladung des österreichischen Kanzlers Metternich, der seine Produkte auf der Ausstellung des Vereins der Kunstfreunde Koblenz gesehen hatte und ihm vorschlug, sein Patent in Österreich zu entwickeln, verließ Michael Thonet im Jahre 1842 das in Deutschland gelegene Boppard, um sich in Wien niederzulassen. 1853 gründete er gemeinsam mit seinen fünf Söhnen das Unternehmen „Gebrüder Thonet“. In der Hauptstadt des habsburgischen Reiches ging Michael Thonet von der Technik des geleimten Lamellenholzes zu der des unter Dampf gebogenen Rundholzes über, d.h. zu einem chemisch-mechanischen Verfahren industrieller Natur. Dank dieser Innovation begann er, Holzmöbel herzustellen, indem er eine Kollektion mit vier gleichermaßen eleganten und rationalen Formen schuf. Zugleich erlaubte ihm das dabei angewandte Verfahren die Herstellung großer Mengen. Dazu gesellte sich sofort ein Vertriebs- und Verkaufssystem, das in

der Lage war, in jeden beliebigen Markt vorzudringen. In jener Zeit entstanden Produkte wie der Stuhl „Nr. 1“, der für das berühmte Palais Schwarzenberg in Wien entworfen wurde. Er gilt als der „typische“ Thonetstuhl, von dem später die unzähligen Modelle bis hin zum Stuhl „Nr. 14“ abgeleitet wurden. Der Einsatz modernster Technologien und Herstellungsverfahren, die Verbreitung der Produkte und die zunehmende Bekanntheit des Unternehmens veranlassten die bedeutendsten Wiener Architekten dazu, neue Produkte zu entwerfen. Otto Wagner ließ die Einrichtung für die Postsparkasse herstellen. Adolf Loos entwarf den Stuhl für das Café Museum und schrieb 1895: „Als ich in Amerika war, begriff ich, dass der Thonetstuhl der modernste Stuhl ist, den es gibt.“ Im Jahre 1911 zählte der Katalog der Gebrüder Thonet 980 verschiedene Modelle. Am Ende des Zweiten Weltkriegs entstanden in verschiedenen Ländern unabhängige Produktionseinheiten, die sich in getrennte Unternehmen entwickelten. In Österreich, dem Heimatmarkt von

Gebrüder Thonet, wurde das Geschäft von Michael Thonets Nachfahren wieder aufgebaut, darunter sein Urgroßenkel Fritz Jakob Thonet sowie dessen Kindern Evamarie Thonet und Richard Thonet. Nach dem Krieg mussten sie ganz von vorn anfangen, mit kaum mehr als ihrer Erfahrung und Leidenschaft für Möbel. Unmittelbar nach dem Krieg nahmen sie in einem ehemaligen Wiener Warenlager von Gebrüder Thonet die Geschäftstätigkeit wieder auf. Von 1948 an pachteten sie eine Fabrik in Rohrau, Steiermark, bevor sie 1962 schließlich ihre eigene Fabrik in Friedberg eröffneten. 1976 änderten sie den Namen von Gebrüder Thonet in den heutigen Namen Gebrüder Thonet Vienna. In jüngster Zeit entwickelte Gebrüder Thonet Vienna GmbH (GTV) ihre Tätigkeit zwischen Tradition und Innovation, Kontinuität und Erneuerung und rief ein gegliedertes Produktionsprogramm ins Leben, das sich in erster Linie zum Ziel setzt, eine Reihe historischer, von Gebrüder Thonet geschaffener Gegenstände in Form einer Neuausgabe

anzubieten. Zugleich repräsentiert GTV die Vorstellung von zeitgenössischer Einrichtung. Durch den Einsatz fortschrittlicher Produktionstechniken werden Design und Materialverwendung weiterentwickelt, um sehr begehrte, vielfältig einsetzbare Einrichtungsgegenstände zu schaffen. Es handelt sich um innovative und zeitgemäße Lösungen, die sich nahtlos in die klassischen Stücke des Produktkatalogs einreihen. Die aufgrund von Form und Verarbeitungsqualität in die Geschichte eingegangenen Stücke, wie der Stuhl Nr. 14, der zwischen 1850 und 1930 mehr als 50 Millionen mal hergestellt wurde, können noch heute Emotionen hervorrufen und neue Generationen faszinieren. GTV gelingt es, Tradition und Innovation perfekt miteinander zu kombinieren und dabei stets nach neuen, klaren und vielseitigen Formen zu streben. GTV ist offen und zukunftsgerichtet, ohne dabei die Werte und Erfahrungen aus der Vergangenheit aufzugeben. Diese Kollektion spiegelt die Evolution unserer Zeit wider.



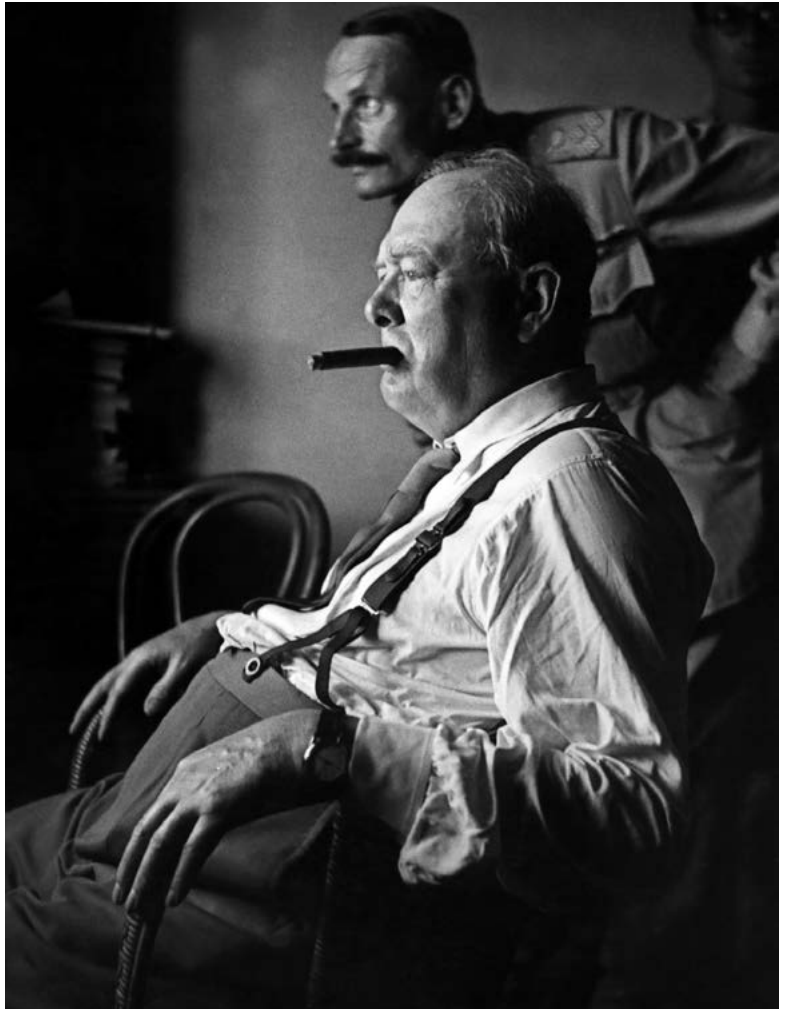

Winston Churchill (CPT TANNER - No 2 Army Film and /AFP/Getty Images)



Rita Hayworth and Gene Kelly (Ned Scott/John Kobal Foundation/Getty Images)



Le Corbusier (Wolfgang Kuhn/United Archives via Getty Images)



Toulouse-Lautrec, Henri de (1864-1901): *At the Moulin Rouge*, digitale (1) 1892/95. Oil on canvas, 123 x 141 cm. Helen - Birch Bartlett Memorial Collection, 1928.610. Chicago (IL), Art Institute of Chicago. © 2018. The Art Institute of Chicago / Art - Resource, NV/ Scala, Firenze

## STORIA

Michael Thonet (1796-1871) e i suoi cinque figli furono i produttori di mobili di maggior successo dell'era industriale. Invitato dal cancelliere austriaco Metternich, che aveva visto i suoi prodotti all'Esposizione della Società degli Amici delle Arti di Coblenza, a sviluppare il proprio brevetto in Austria, nel 1842 Michael Thonet lasciò Boppard, in Germania, per stabilirsi a Vienna, dove nel 1853 fondò l'azienda "Gebrüder Thonet" coinvolgendo i suoi cinque figli. Nella capitale dell'impero asburgico, Michael Thonet passò dalla tecnica del legno lamellare incollato a quella del tondino incurvato a vapore, cioè a un processo chimico e meccanico di tipo industriale. Grazie a questa innovazione iniziò a produrre mobili in legno proponendo una collezione di forme eleganti e insieme razionali, con un procedimento che consentiva la produzione in grande serie. A questo si aggiunse subito, un sistema di distribuzione e di vendita in grado di penetrare qualsiasi mercato. In quel periodo nacquero prodotti come la sedia "N.1" progettata per il famoso palazzo Schwarzenberg di Vienna, considerata la sedia "tipo" Thonet, da cui derivarono poi innumerevoli modelli fino alla sedia "N.14". Conoscenze tecnologiche e produttive di alto livello, diffusione dei prodotti e notorietà dell'azienda spinsero i più importanti architetti viennesi a progettare nuovi prodotti. Otto Wagner fece realizzare gli arredi per la Postsparkasse, Adolf Loos disegnò la sedia per il Café Museum e scrisse nel 1895: "Quando ero in America compresi che la sedia Thonet è la sedia più moderna che ci sia". Nel 1911 il catalogo Gebrüder Thonet contava 980 modelli diversi. Al termine della seconda guerra mondiale nacquero unità di produzione indipendenti in varie nazioni che svilupparono imprese differenti. In Austria, patria di

Gebrüder Thonet, l'attività fu ricostituita da alcuni discendenti di Michael Thonet, compreso il suo bisnipote Fritz Jakob Thonet e i suoi figli Evamarie Thonet e Richard Thonet. Dopo la guerra, dovettero ricominciare dal nulla, con poco più che passione e conoscenza per i mobili. L'attività riprese a Vienna presso uno dei vecchi magazzini di Gebrüder Thonet. A partire dal 1948 Frizjacob, Richard e Evamarie affittarono uno stabilimento a Rohrau, Steiermark, prima di realizzare il loro sito produttivo a Friedberg in 1962. Nel 1976 la società cambiò nome in Gebrüder Thonet Vienna. Recentemente Gebrüder Thonet Vienna GmbH (GTV) ha sviluppato la propria attività fra tradizione e innovazione, continuità e rinnovamento, dando vita ad un programma di produzione articolato, che si propone in primo luogo di recuperare in forma di riedizioni una serie di oggetti storici creati dalla Gebrüder Thonet. Il nome GTV rappresenta l'idea stessa dell'arredamento contemporaneo. Molteplicità delle funzioni d'uso, utilizzo di tecniche produttive avanzate e funzionali alla realizzazione di prodotti unici, innovazione nelle forme e nell'uso dei materiali, uniti ad un design ricercato, sono il fil rouge dei nuovi progetti della GTV, capace di proporre soluzioni innovative attuali ben integrate e coerenti con le riedizioni più classiche del suo catalogo. Pezzi mitici per forma e per qualità di lavorazione, come la sedia N.14, prodotta in oltre 50 milioni di esemplari tra il 1850 e il 1930, riescono ancora oggi ad emozionare ed attrarre nuove generazioni. GTV è in grado di coniugare sempre tradizione e innovazione, ricerca continua di nuove forme e d'alto contenuto di design, sobrietà e versatilità d'uso. GTV è dunque un'azienda aperta al futuro, che trae dal passato i valori e le esperienze per esprimere una collezione che riflette l'evoluzione del nostro tempo.

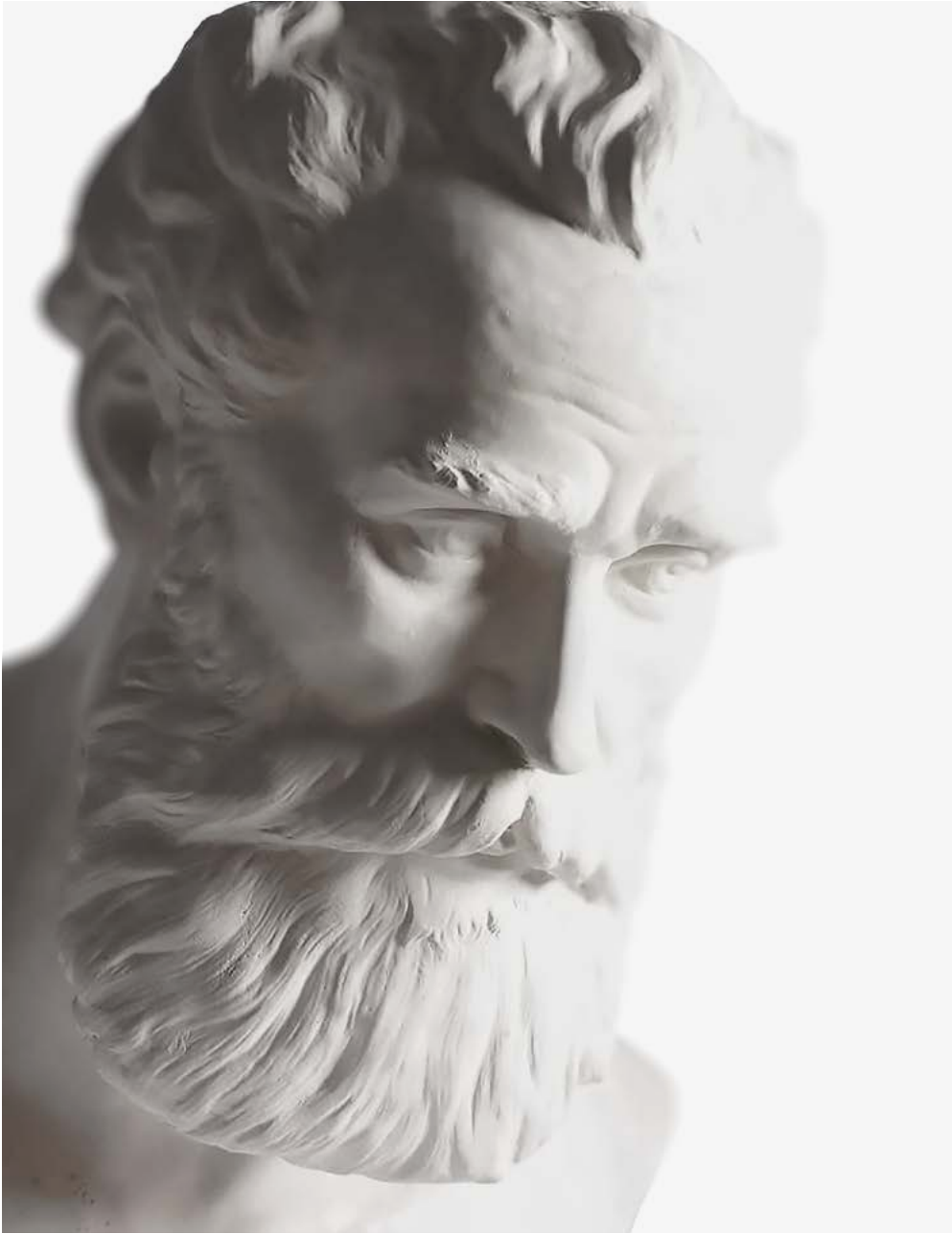

## HISTOIRE

Michael Thonet (1796-1871) et ses cinq fils ont été les producteurs de meubles ayant obtenu le plus grand succès de l'ère industrielle. Invité par le chancelier autrichien Metternich, qui avait vu ses produits à l'Exposition de la Société des Amis des Arts de Coblenze, à développer son brevet en Autriche, en 1842 Michael Thonet laisse Boppard en Allemagne pour s'établir à Vienne, où en 1853 il fonde la société «Gebrüder Thonet» en impliquant ses cinq fils. Dans la capitale de l'empire habsbourgeois, Michael Thonet passe de la technique du bois lamellé collé à celle du bois de section ronde courbé à la vapeur, c'est-à-dire à un processus chimique et mécanique de type industriel. Grâce à cette innovation, il commence à produire des meubles en bois en proposant une collection de formes à la fois élégantes et rationnelles, avec une technique qui permet de produire en grande quantité. À cela s'ajoute très rapidement un système de distribution et de vente en mesure de pénétrer tout type de marché. Au cours de

cette période, naissent des produits tels que la chaise "N. 1" conçue pour le célèbre Palais Schwarzenberg de Vienne, considérée comme étant la chaise "type" Thonet, d'où dérivent par la suite de nombreux modèles jusqu'à la chaise "N. 14". Des connaissances technologiques et de production de haut niveau, la diffusion des modèles et la notoriété de l'entreprise poussent les plus grands architectes viennois à réaliser de nouveaux produits. Otto Wagner fait réaliser les décorations pour la Postsparkasse, Adolf Loos dessine la chaise pour le Café Museum et en 1895 il écrit: "Lorsque j'étais en Amérique, j'ai compris que la chaise Thonet est la chaise la plus moderne qui soit". En 1911, le catalogue Gebrüder Thonet compte 980 modèles différents. À la fin de la seconde guerre mondiale, des unités de production indépendantes, qui ont développé différentes entreprises, naissent dans différents pays. En Autriche, la patrie de Gebrüder Thonet, l'activité a été reconstitué par certains descendants

de Michael Thonet, dont son arrière-petit-fils Fritz Jakob Thonet et ses fils Evamarie Thonet et Richard Thonet. Après la guerre, ils ont dû repartir de zéro, avec un peu plus que la passion et les connaissances pour le mobilier. Les activités ont repris à Vienne à l'un des anciens entrepôts de Gebrüder Thonet. Depuis 1948 Frizjacob, Richard et Evamarie loué une usine à Rohrau, Steiermark, avant de faire leur site de production à Friedberg en 1962. En 1976 le nom de la société a changé en Gebrüder Thonet Vienna. Récemment, Gebrüder Thonet Vienna GmbH (GTV) a relancé sa vocation pour l'ameublement de caractère, en développant son activité entre tradition et innovation, continuité et renouvellement, en faisant naître un programme de production articulé qui se propose, en premier lieu, de récupérer sous forme de rééditions, une série d'objets historiques créés par Gebrüder Thonet. Le nom de GTV représente l'idée même de l'ameublement contemporain. La multiplicité des fonctions d'utilisation,

l'emploi de techniques de production avancées et fonctionnelles jusqu'à la réalisation de produits uniques, l'innovation dans les formes et dans les matériaux, ainsi qu'un design recherché, représentent le fil rouge des nouveaux projets de GTV, capable de proposer des solutions innovantes, actuelles, bien intégrées et cohérentes avec les rééditions les plus classiques de son catalogue historique. Des pièces mythiques pour la forme et pour la qualité d'élaboration, comme la chaise "N. 14", produite en plus de 50 millions d'exemplaires entre 1850 et 1930, réussissent encore aujourd'hui à émouvoir et à attirer de nouvelles générations. GTV est toujours en mesure de conjuguer tradition et innovation, recherche constante de nouvelles formes et haut contenu en design, sobriété et flexibilité d'utilisation. GTV est donc une entreprise ouverte vers le futur, qui tire du passé les valeurs et les expériences pour exprimer une collection reflétant l'évolution de notre époque.





Actress Anita Ekberg Posing on Chair (Corbis Historical/Getty Images)

# TIMELESS AUTHENTICITY

Gebrüder Thonet Vienna chooses a label with a technological heart to certify the authenticity of its collections. A blockchain system, guarded by a microchip, allows information to be obtained through NFC (Near Field Communication), simply using electronic devices.

This step is part of an ideal dialogue between technology and production. Already in the 19th century, Michael Thonet had introduced a marking system in his production. Initially, the first firestamps branded on the inside of the seats 'Thonet Wien Gump 396', which bore the name of the company together with the place of manufacture (the laboratory in Vienna at 396 Gumpendorf Street), were combined with letters and numbers, applied on the chair legs, to simplify the assembly of the products that used to be delivered disassembled to customers all over the world.

After 1853, with the increasing expansion of the business, the most common firestamps became 'GbThonet', 'Thonet' 'Wien' or 'Gt'; later, after 1856, it can be found 'GB.THONET Wien' or 'GB. THONET WIEN', until simply setting on THONET or THONET AUSTRIA in the late 19th century.

The great international success gave birth to numerous companies that marketed similar models of curved wooden chairs. The need to distinguish its products from those of its competitors became a priority and the practical function of firebranding was complemented by the certification of authenticity, provided by the introduction of paper labels glued inside the seat.

The search for useful tools to contrast counterfeiting has seen a significant breakthrough in recent years, when, starting from 2014, Gebrüder Thonet

Vienna GmbH (GTV) introduced a coin engraved with the 'Wiener GTV Design' logo alongside the firebrand mark, which showed the year of manufacture. The coin's identification system had been experimented already in the early 2000s.

The solution applied today hence finds an echo in the company's long history. The new technological label has pleasantly classic lines and is placed in the wooden frame of the seats, in a position opposite to the brand-embossed mark. A choice that benefits the traceability and transparency of the products and protects both the company and customer.

A fascinating journey that spans three centuries and tells the efforts needed to recognise intellectual property and the company's attention to valuing authenticity, the manufacturing process and the quality of the product.

# Thonet Wien Gump 396

ca. 1853

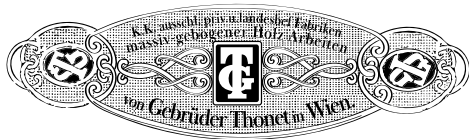

ca. 1861

# GB.THONET Wien

ca. 1857



ca. 1881

# THONETAUSTRIA

ca. 1885



ca. 1930



ca. 1940



ca. 2000



since 2014

GEBRÜDER THONET VIENNA GmbH  
Prinz-Eugen-Straße 42, 1040 WIEN  
IM JAHR 2023

since 2014



since 2023

# THE GREEN CHALLENGE



Year after year, GTV has become increasingly sensitive to environmental issues and with a view to achieving continuous improvement, it complies with the regulations that privilege the use of sustainable processes and materials. A clear sign, an incisive foothold, which marks a path that looks keenly towards the continuity, also ethical, between the production cycle and the product. A major commitment

taken by the company to offer concrete guarantees in terms of environmental friendliness and care for the consumer's health, with the aim of establishing a trust-based relationship through an approach integrated within sustainable development. To manufacture its collections, Gebrüder Thonet Vienna GmbH chooses to use wood certified by the FSC®, Forest Stewardship Council®,

the main international certification system that ensures that wood is sourced from forests where stringent environmental, social and economic standards are observed. There are also other types of processing on Gebrüder Thonet Vienna products, which are less visible yet just as important - for greater sustainability. Indeed, the company has begun to convert its painting process, moving away from



polyurethane-based paints towards the use of water-based paints, both to cut down atmospheric emissions, as well as for greater protection of the staff in charge of this particular process. In 2021 GTV has inaugurated a new Green project, introducing products that are entirely sustainable, including the new Beaulieu chair, designed by Philippe Nigro. For these FSC certified products

coated with water-based paint, the company is offering a polyurethane padding produced with the innovative Variable Pressure Foaming (VPF) technology which makes it possible not to use foaming agents that are harmful for the environment, obtaining a material that is foamed solely with water, totally eco-compatible and recyclable. For the upholstery cover, the company uses a selection of fabrics made

from plastic or natural recycled fibres. Moreover, GTV uses recycled and sustainable materials for the chair's support feet too, and these can easily be replaced simply with a click-in system. From the finished product to its packaging for dispatch, in FSC certified cardboard, all the internal components are also made of recyclable material and separate, in order to be disposed of in full.

# THE TECHNIQUE OF WOOD BENDING

The technique of wood bending is a very ancient technique existing in the craftsmanship of different civilizations, but remained in the corners for a long time due to a limited advantage in productivity.

## the technique

The intuition of Michael Thonet took the moves from the observation that fresh wood is more flexible than dry wood : Starting from this consideration, Thonet and some of his contemporaries tested the bending of the wood sheets packets, dipped in boiling glue and then dried into rigid forms.

This solution, however, did not guarantee the strength of the product, because of the precarious nature of the adhesive. To overcome this problem, Thonet tried to work only on the physical properties of the wood, by excluding all the glue from his procedures, in order to recover a considerable flexibility of the material – even after aging – by increasing the smoothness between the fibers by placing them in highly humid environment.

## the patent

In 1842, Michael Thonet patented the process that made him famous throughout the world: the wood strips (beech, by far the favorite for its long, regular and knotless fiber) are turned, placed in an autoclave to absorb moisture, bent by force and fixed in metal forms, and finally dried; the finishing of the pieces was followed by the assembly of the “Vienna straw”, another element that became characteristic for the company.

A real industrial process that went hand in hand with the progressive elimination of ornaments and joints, in favour of a rigorous line and careful attention to the simplification of the joining elements.

Formal elegance, solidity and lightness have determined the success of the company that in a few years started production sites all over the world. A unique production process that has its roots in a history rich in suggestions and that is now renewed in the high quality of materials that Gebrüder Thonet Vienna chooses to make its products, characterized by valuable elements that unite them with high craftsmanship. The woods, selected for their strength and versatility, are combined with fabrics that enrich the range of colors proposed by the collection with precious nuances.

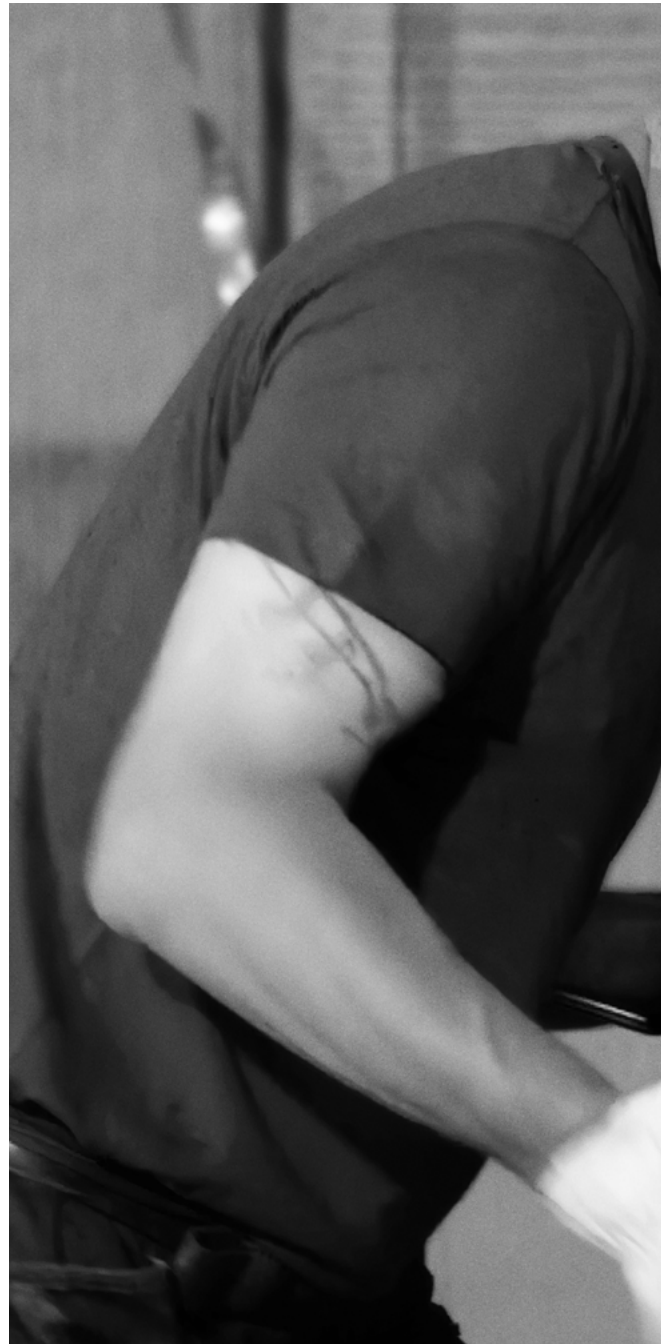



# DESIGNERS



ADOLF LOOS



ANKI GNEIB



AUGUST THONET



CHARLIE STYRBJÖRN NILSSON



CHIARA ANDREATTI



CRISTIAN MOHADED



CRISTINA CELESTINO



DAINELLI STUDIO



ED NG, AB CONCEPT



FABIO FANTOLINO



FRANCESCA DE GIORGI



FRONT

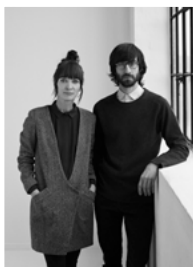

GAMFRATESI



GORDON GUILLAUMIER



HERMANN CZECH



INDIA MAHDAVI



JOSEF HOFFMANN





KOLOMAN MOSER



LUCA NICHETTO



LUCIDIPEVERE



MARTINO GAMPER



MICHAEL ANASTASSIADES

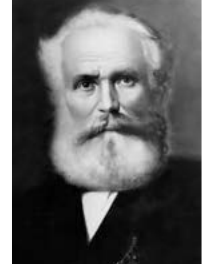

MICHAEL THONET



MICHELE DE LUCCHI



NATHAN YONG



NIGEL COATES



OTTO WAGNER



PAOLA PASTORINI

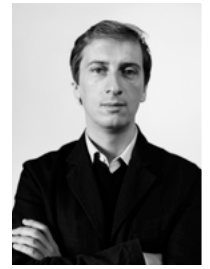

PHILIPPE NIGRO



SERENA CONFALONIERI

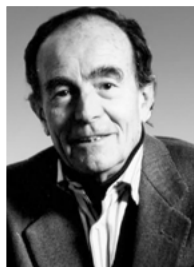

VICO MAGISTRETTI



OKI SATO, NENDO



SERVOMUTO



STORAGEMILANO



TESTATONDA

SEE PAG. 350 FOR PHOTO CREDITS OF DESIGNER PORTRAITS

# FRIEDBERG THONET MUSEUM

In Friedberg, Styria (Austria), the „Thonet“ museum, owned by GTV, is a benchmark for its history, where testimonies, curiosities and the most representative original parts of the company find the place to be. A fascinating reality that through these icons of style tells the company's deep passion for the solid bent wood.



COLLECTIONS







**AMPLE**  
DESIGN NICHETTO STUDIO, 2023















**BEAULIEU**  
DESIGN PHILIPPE NIGRO, 2021









**BISTROTSTUHL**  
DESIGN NIGEL COATES, 2016





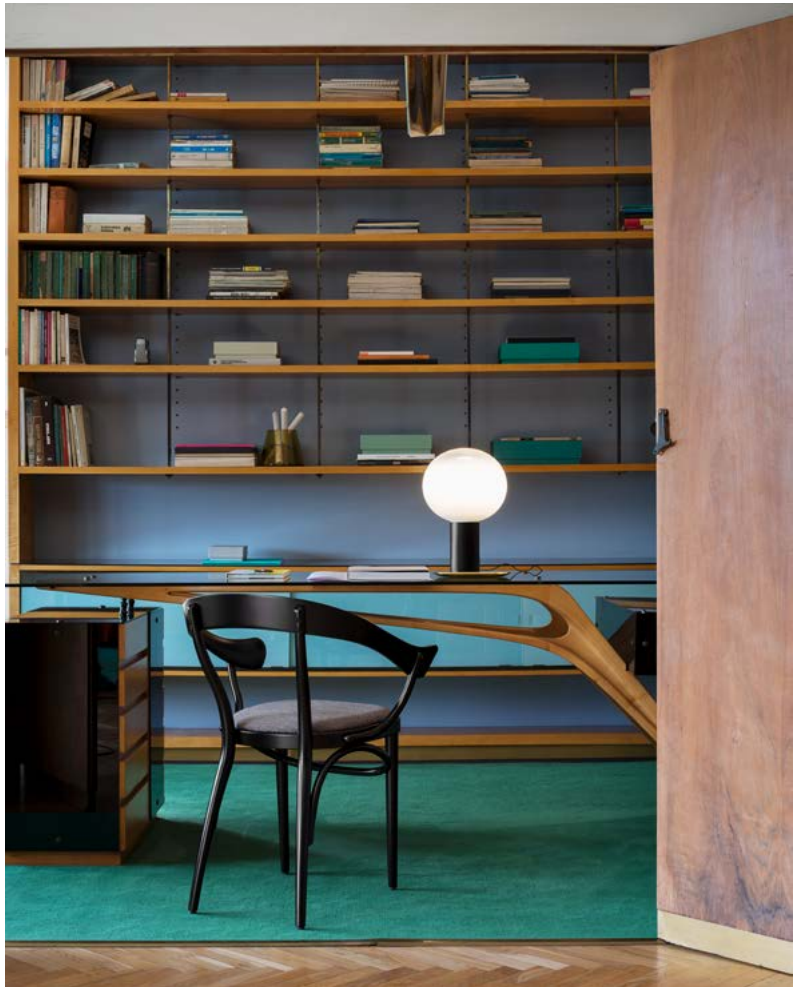

# BODYSTUHL

DESIGN NIGEL COATES, 2015









# BREZEL

DESIGN LUCIDIPEVERE, 2014





# CAFÉSTUHL

DESIGN NIGEL COATES, 2016







# CZECH

DESIGN HERMANN CZECH, 1994













A long, white dining table with a dark wood frame. On the table, there is a large, dark brown ceramic vase and a smaller, round, dark brown ceramic bowl resting on a dark metal tray.

Two wooden chairs with curved backs and armrests, featuring red plaid upholstered seats. They are positioned at the end of the dining table, facing the double door.

A large window with dark wood framing and white louvered shutters. The window is partially open, and a metal rack is visible in front of it.

A double door with dark wood frames and glass panels. The glass panels show a view of a green lawn and trees outside. The doors have brass handles and are set within a decorative white frame.

The ceiling features decorative floral murals in shades of brown and green, depicting leaves and flowers. The murals are framed by dark wood crown molding.

A decorative light fixture with a white, tiered, classical-style top and a glass globe. It is mounted on the wall above a doorway.

A small, round, white light fixture mounted on the wall.

A dark wood door with a glass panel, featuring a brass handle and a decorative metal pull. The door is partially open, revealing a glimpse of the room beyond.

A large, dark brown ceramic vase and a smaller, round, dark brown ceramic bowl resting on a dark metal tray.

A large, dark brown ceramic vase and a smaller, round, dark brown ceramic bowl resting on a dark metal tray.







**GUSTAV**  
DESIGN GORDON GUILLAUMIER, 2014





# HAGU

DESIGN AB CONCEPT-ED NG, 2023









# LOOS CAFÉ MUSEUM

DESIGN ADOLF LOOS, 1898







**MAGISTRETTI**  
DESIGN VICO MAGISTRETTI, 2003





**MALIT**  
DESIGN GEBRÜDER THONET VIENNA GMBH (GTV), 2017





MORRIS

DESIGN GAMFRATESI, 2015





N. O  
DESIGN FRONT, 2017











**N. 1**

DESIGN MICHAEL THONET, 1850





# N. 14

DESIGN MICHAEL THONET, 1860



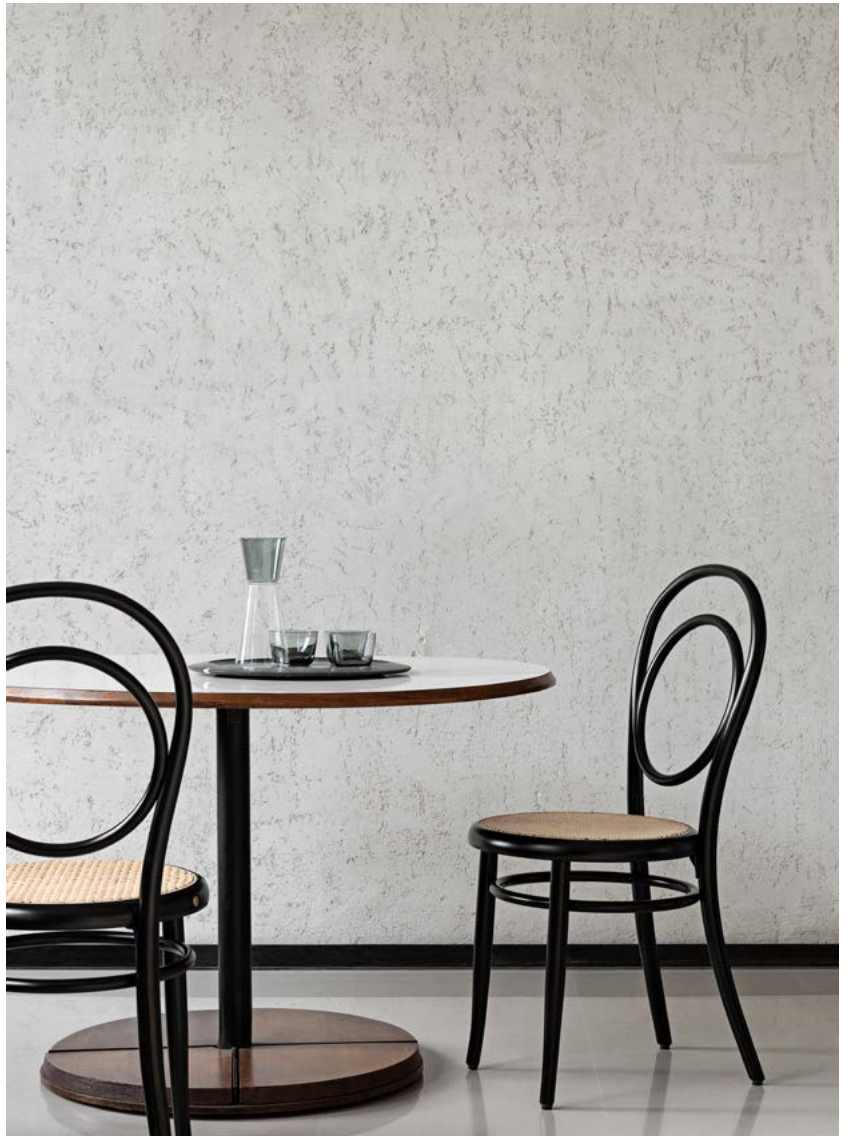

**N. 18 COLLECTION**  
DESIGN GEBRÜDER THONET, 1876







# N. 811 COLLECTION

DESIGN JOSEF HOFFMANN, 1930













PINCE  
DESIGN LUCIDIPEVERE, 2017







**POST MUNDUS**  
DESIGN MARTINO GAMPER, 2012





# POSTSPARKASSE COLLECTION

DESIGN OTTO WAGNER, 1906





# RADETZKY

DESIGN MICHELE DE LUCCHI, 2015





# SÖLDEN

DESIGN GEBRÜDER THONET VIENNA GMBH (GTV), 2020











# SUGILOO

DESIGN MICHAEL ANASTASSIADES, 2020









**VIENNA 144**  
DESIGN GEBRÜDER THONET, 1908







**WIENER STUHL**  
DESIGN GEBRÜDER THONET, 1904









**CIRQUE**  
DESIGN MARTINO GAMPER, 2015





# COAT RACK BENCH

DESIGN FRONT, 2014







# SINGLE CURVE COLLECTION

DESIGN NENDO, 2015



essere non più pelle su caviglie profonde non più frammenti ma forme gravi scolpite nella materia in un singolo gesto puro e a











**TRIO**  
DESIGN MARTINO GAMPER, 2015







# VIENNA 144 STOOLS

DESIGN GEBRÜDER THONET, 1908

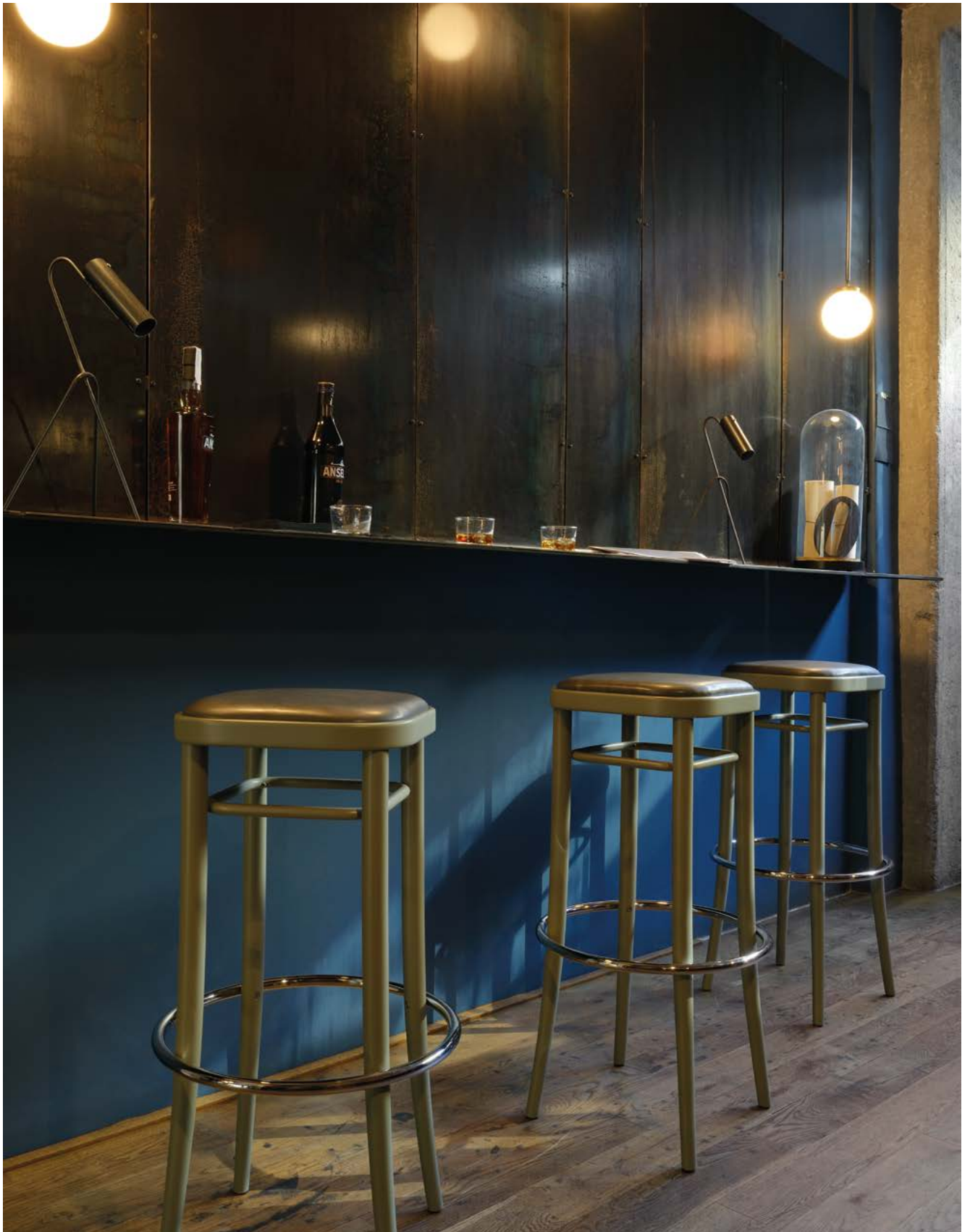



CHIGNON

DESIGN LUCIDIPEVERE, 2017





# HIDEOUT COLLECTION

DESIGN FRONT, 2015















# JANNIS COLLECTION

DESIGN DAINELLI STUDIO, 2020









**LEHNSTUHL**  
DESIGN NIGEL COATES, 2014











LOÏE  
DESIGN CHIARA ANDREATTI, 2018









# LOOP COLLECTION

DESIGN INDIA MAHDAVI, 2022



















# LUFTBALLON COLLECTION

DESIGN GEBRÜDER THONET VIENNA GMBH (GTV), VALTER CAGNA (DESIGN DEPT.)

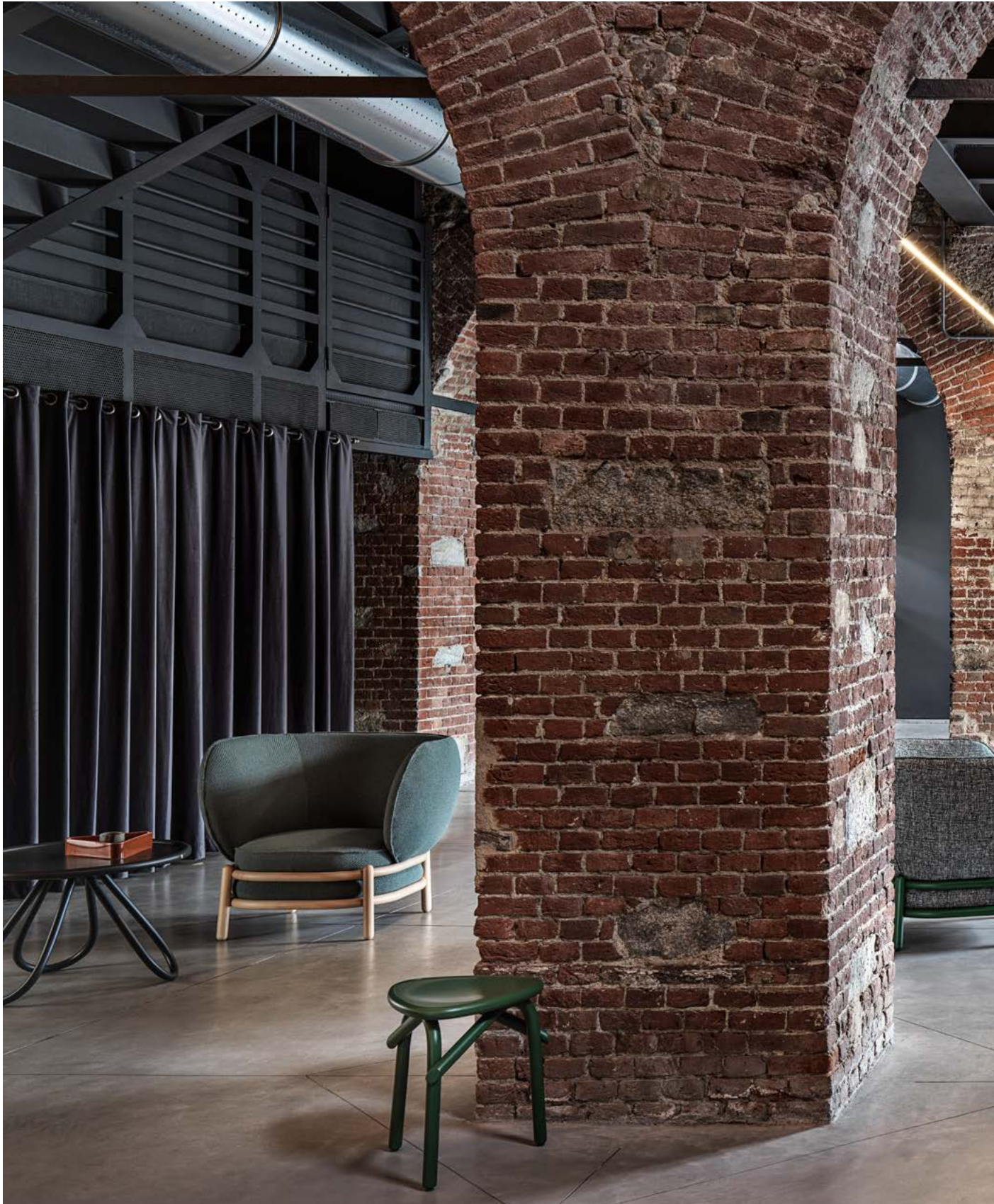







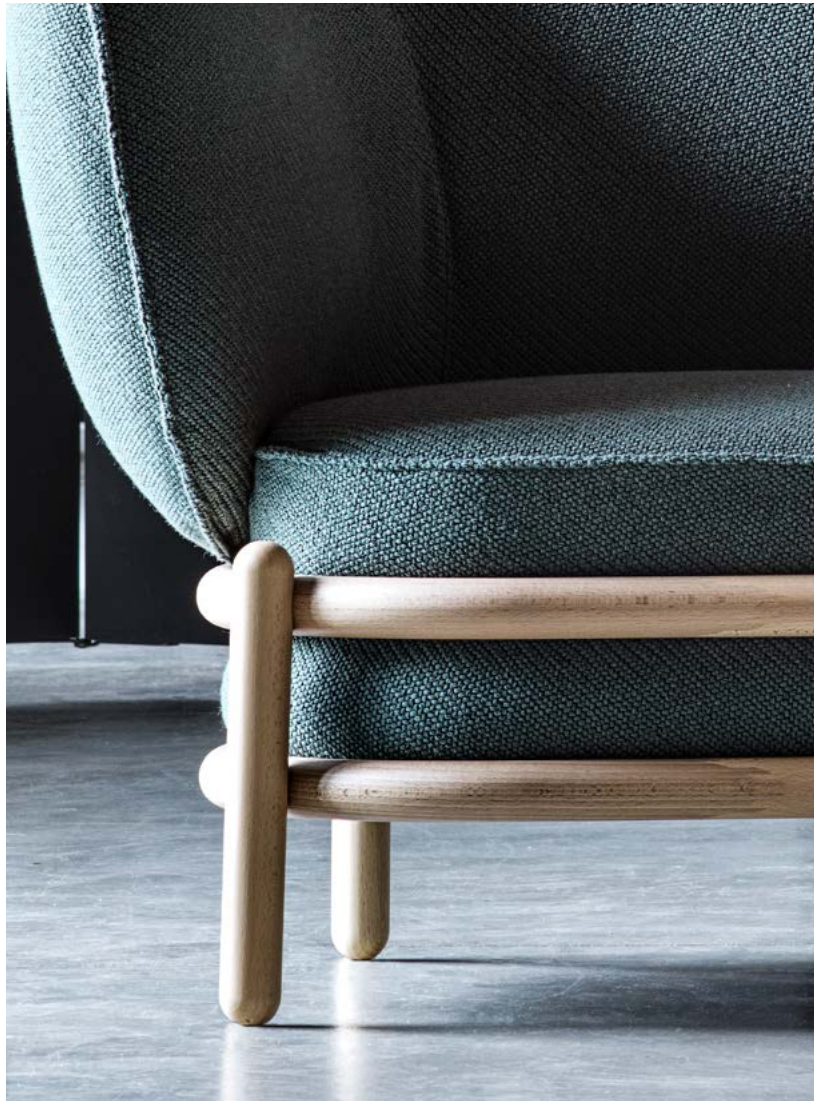



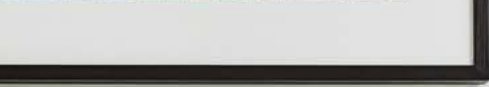

**MICKEY**  
DESIGN INDIA MAHDAVI, 2023





# N. 200

DESIGN MICHAEL ANASTASSIADES, 2019











# PROMENADE COLLECTION

DESIGN PHILIPPE NIGRO, 2017









**SCHAUKELSTUHL**  
DESIGN GEBRÜDER THONET, 1885





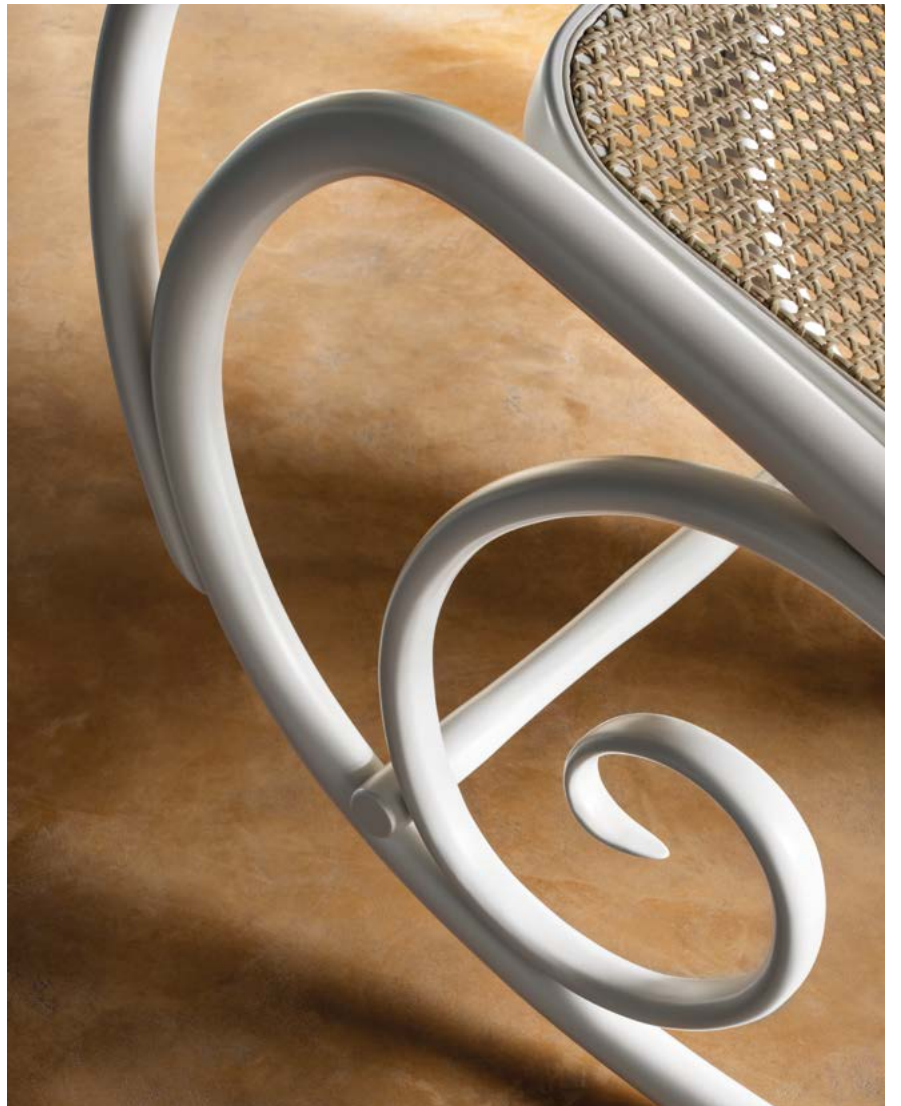

# SUZENNE COLLECTION

DESIGN CHIARA ANDREATTI, 2019







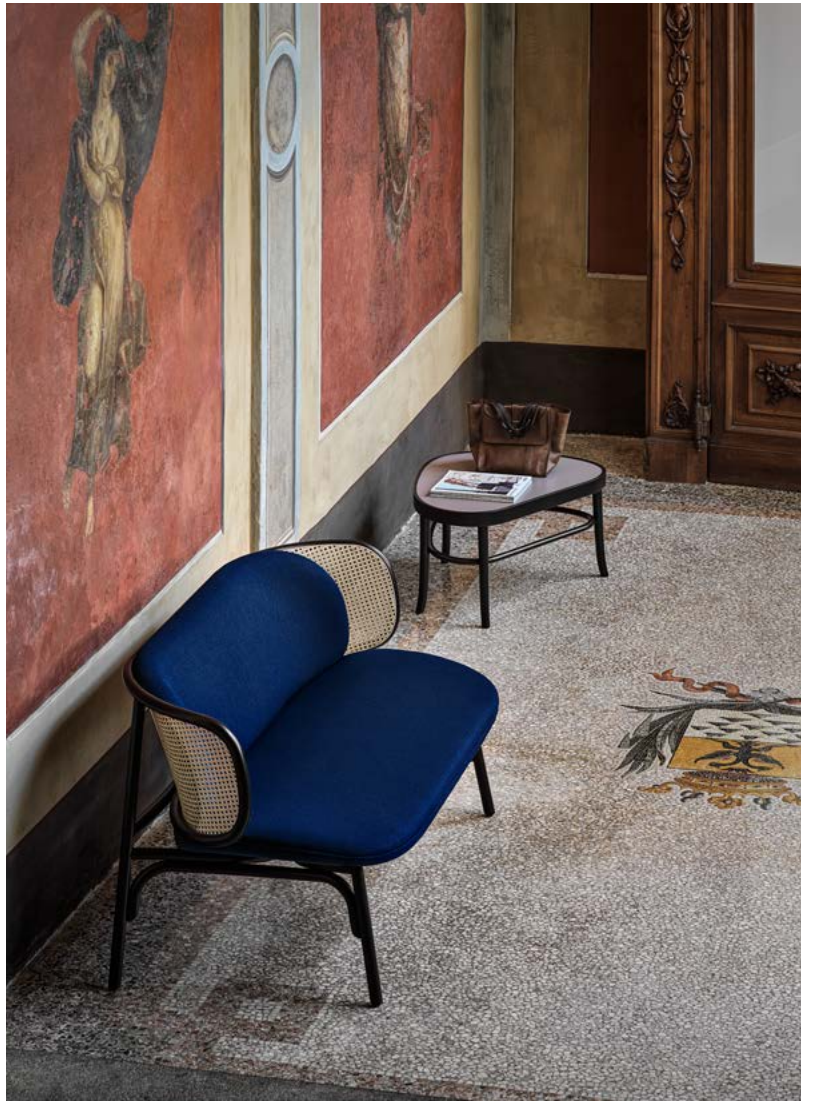

# TARGA COLLECTION

DESIGN GAMFRATESI, 2015















# MOS COLLECTION

DESIGN GAMFRATESI, 2019























# NYNY COLLECTION

DESIGN STORAGE MILANO, 2020















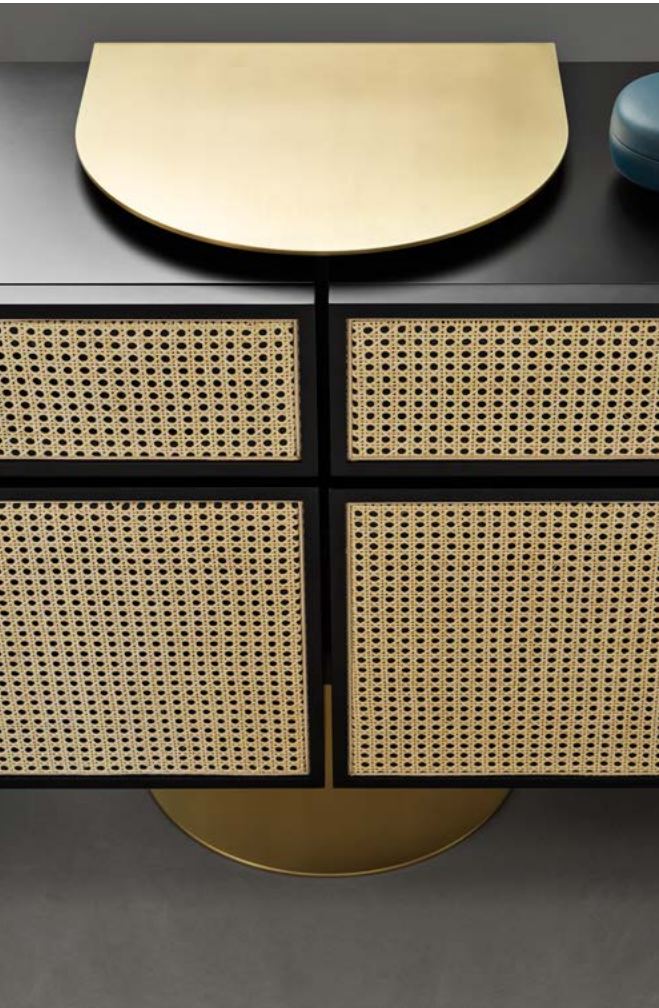







OTTOW  
DESIGN STORAGE MILANO, 2019











**RUE**  
DESIGN GAMFRATESI, 2019









**YVETTE**  
DESIGN CHIARA ANDREATTI, 2019







# ARCH DINING TABLE

DESIGN FRONT, 2014





**CARYLLON**  
DESIGN CRISTINA CELESTINO, 2018









**REHBEINTISCH**  
DESIGN GEBRÜDER THONET, 1888











# RING DINING TABLE

DESIGN GEBRÜDER THONET VIENNA GMBH (GTV), 2015





**SÄULE**  
DESIGN FABIO FANTOLINO, 2021























# COGNAC

DESIGN GEBRÜDER THONET VIENNA GMBH (GTV), 2018





GIN

DESIGN GEBRÜDER THONET VIENNA GMBH (GTV), 2021



# PASTIS

DESIGN GEBRÜDER THONET VIENNA GMBH (GTV), 2014



# PORTO

DESIGN GEBRÜDER THONET VIENNA GMBH (GTV), 2014



# RUM

DESIGN GEBRÜDER THONET VIENNA GMBH (GTV), 2020



# SHERRY

DESIGN GEBRÜDER THONET VIENNA GMBH (GTV), 2018



# VERMOUTH

DESIGN GEBRÜDER THONET VIENNA GMBH (GTV), 2014











# ARCH COFFEE TABLE

DESIGN FRONT, 2014





**DETOUR**  
DESIGN GAMFRATESI, 2022









**DUET**  
DESIGN CRISTIAN MOHADED, 2017







PEERS  
DESIGN FRONT, 2020









# WIENER BOX

DESIGN CRISTIAN MOHADED, 2018











# ALLEGORY DESK

DESIGN GAMFRATESI, 2015





ARCADIA  
DESIGN SERENA CONFALONIERI, 2022





CLOUD

DESIGN GEBRÜDER THONET, 1890



# EYESHINE MIRRORS

DESIGN ANKI GNEIB, 2015



**FENG**  
DESIGN TESTATONDA, 2021











**FURIA**  
DESIGN FRONT, 2016





# KLEIDERSTÄNDER

DESIGN GEBRÜDER THONET, 1905



# KLEIDERSTÄNDER P29

DESIGN GEBRÜDER THONET, 1929

Two days, the first solo exhibition in Italy of works by Calvin Cordwell, will include installations, sculpture, fashion projects that they work together with a new one especially created for Pirelli Hangerforce, which will involve an unprecedented collaboration between the artist and Pirelli's production facilities.

For this occasion, Calvin Cordwell will be working with the Street, dividing it into two spaces: one using natural light ("day") and the other with a greater degree of darkness ("night"). Visitors will visit their very own works – some of which they will be able to activate themselves – which are inspired by the visual language of industrial design, architecture and sculpture. The frames of the exhibition include a reflection on the influence of manufacturing processes on human relationships and on the surrounding environment.

The practice of Calvin Cordwell (b. Paris, 1976) involves the creation of works, writings and a questioning of the boundaries between content and artistic disciplines. Her work brings together art and architecture in a comprehensive manner, involving the individual's network of relationships with the world, which require concrete shapes in the form of cultural, economic, social and physical elements that the artist refers to as "Support Structures". She is a co-founder and curator of the Outside Projects space in Birmingham, in 2010 she exhibited at Manifesta 8, the European Biennial of Contemporary Art, and in 2014 the Chisenhale Gallery in London and the San Abdon Museum in Eindhoven devoted two solo exhibitions to her work. In 2008, she wrote and edited a book entitled Support Structures and she has recently published The Company She Keeps.



**KOLO MOSER**  
DESIGN KOLOMAN MOSER, 1905

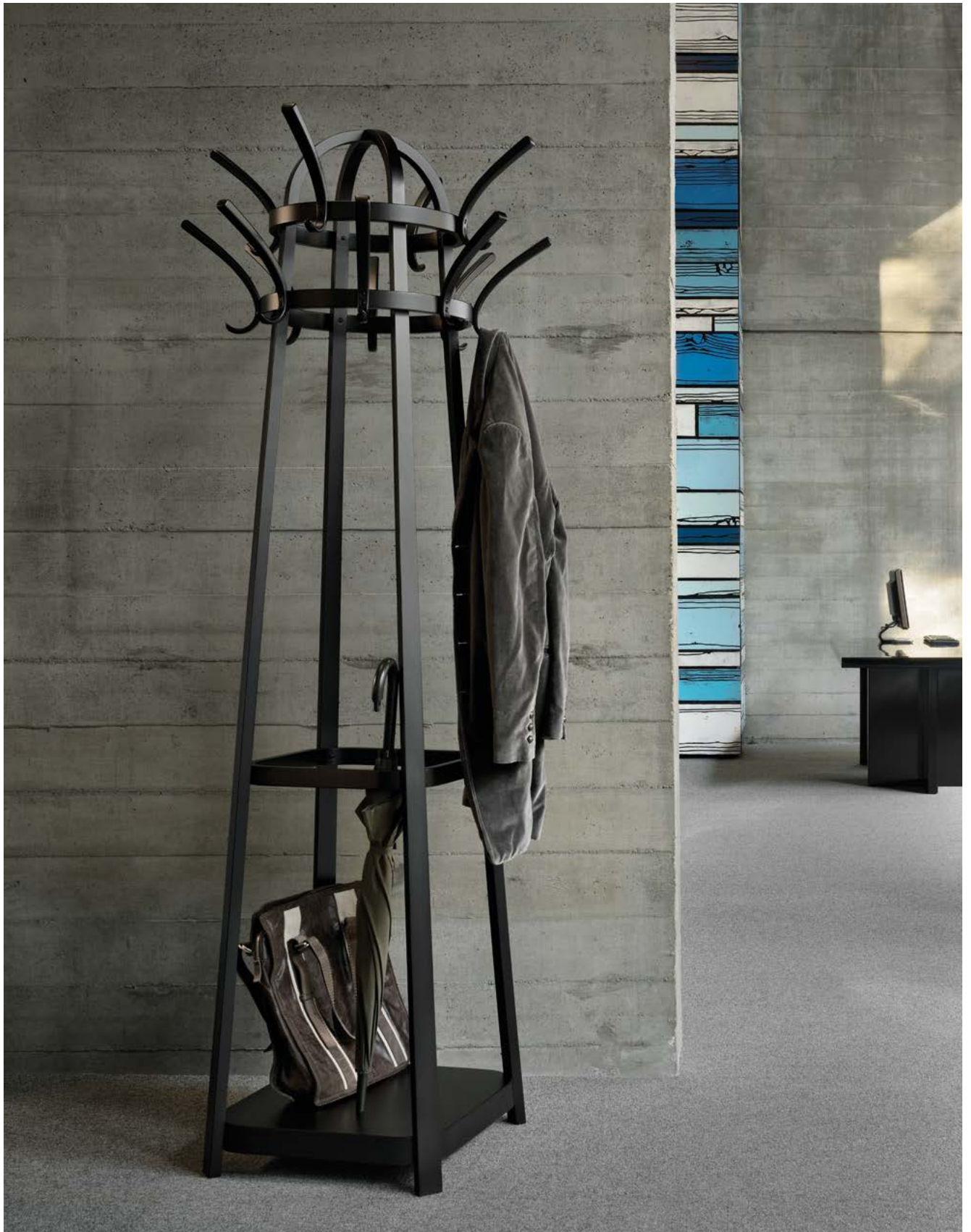





# LADDER

DESIGN CHARLIE STYRBJÖRN NILSSON, 2014





**MAJORDOMO**  
DESIGN NATHAN YONG, 2016



# ARCH CLOTHES VALET

DESIGN FRONT, 2014



**STOCKSSEL**  
DESIGN GEBRÜDER THONET, 1866





**WALTZ**  
DESIGN GAMFRATESI, 2016







**TIPÌ**  
DESIGN FRANCESCA DE GIORGI, 2023





**WAGASA**  
DESIGN SERVOMUTO, 2017





# AROUND COLORS RUGS COLLECTION

DESIGN PAOLA PASTORINI, 2021

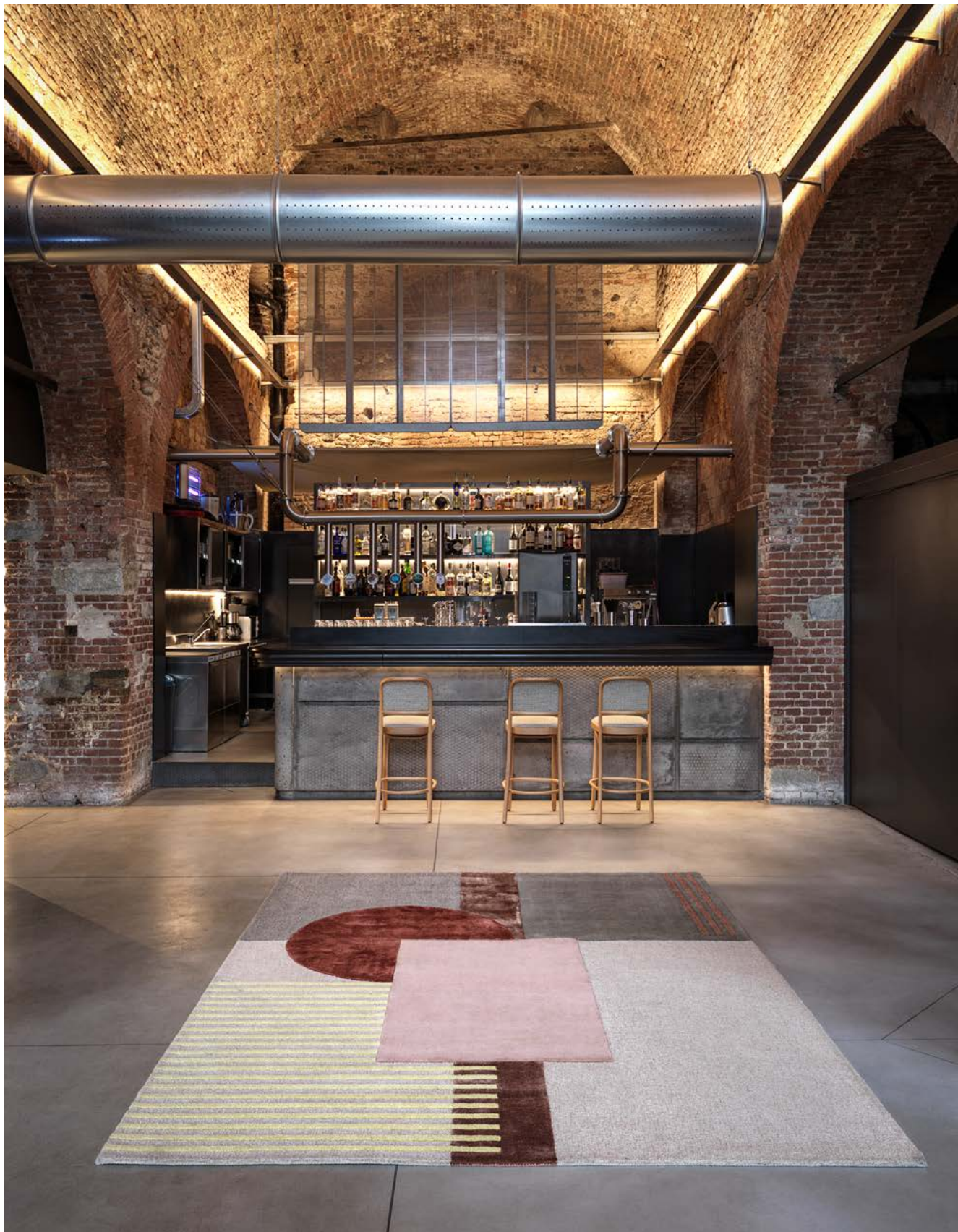











ABACUS

## ALPHABETICAL SUMMARY

---

- Allegory Desk** 340
- Ample** 304
- Arcadia** 341
- Arch Clothes Valet** 341
- Arch Coffee Table** 338
- Arch Dining Table** 332
- Around Colors Rugs Collection** 347
- Beaulieu** 305
- Bistrotstuhl** 305
- Bodystuhl** 306
- Brandy** 335
- Brezel** 306
- Caféstuhl** 306
- Caryllon Dining Table** 333
- Chignon** 322
- Cirque** 317
- Cloud** 341
- Coat Rack Bench** 321
- Cognac** 336
- Czech** 307
- Duet** 338
- Eyeshine Mirrors** 342
- Feng** 342
- Furia** 343
- Gin** 336
- Gustav** 307
- Hagu** 308
- Hideout** 322
- Jannis** 323
- Kleiderständer** 343
- Kleiderständer P. 29** 343
- Kolo Moser** 343
- Ladder** 344
- Lehnstuhl** 324
- Loïe** 324
- Loop Dining Chair** 308
- Loop Lounge And Banquette** 325
- Loos Café Museum** 308
- Luftballon** 325
- Magistretti 0301** 309
- Magistretti 0302** 334
- Majordomo** 344
- Malit** 309
- Mickey** 326
- Morris** 309
- Mos Bench** 321
- Mos Bookcase** 329
- Mos Cabinet** 329
- Mos Console** 329
- Mos Side Table** 339
- N. 0** 310
- N. 1** 310
- N. 14** 311
- N. 18** 311
- N. 18 Barstool** 317
- N. 200** 326
- N. 811** 312
- N. 811 Barstool And Counter** 318
- NYNY Drawers** 330
- NYNY Sideboard** 330
- NYNY Unit** 330
- Ottow** 331
- Pastis** 336
- Peers** 339
- Pince** 312
- Porto** 336
- Post Mundus** 313
- Postsparkasse** 313
- Postsparkasse Hocker** 318
- Promenade** 327
- Radetzky** 314
- Rehbeintisch** 334
- Ring Dining Table** 334
- Rue** 331
- Rum** 337
- Säule** 335
- Schaukelstuhl** 327
- Sherry** 337
- Single Curve Barstool** 319
- Single Curve Counter** 319
- Single Curve Low Tables** 339
- Single Curve Stool** 319
- Sölden** 314
- Stocksessel** 344
- Sugiloo** 314
- Suzenne** 328
- Targa** 328
- Tipi** 346
- Trio** 320
- Vermouth** 337
- Vienna 144** 315
- Vienna 144 Stools** 320
- Wagasa** 346
- Waltz** 345
- Wiener Box** 340
- Wiener Stuhl** 316
- Yvette** 331

# TECHNICAL SHEET

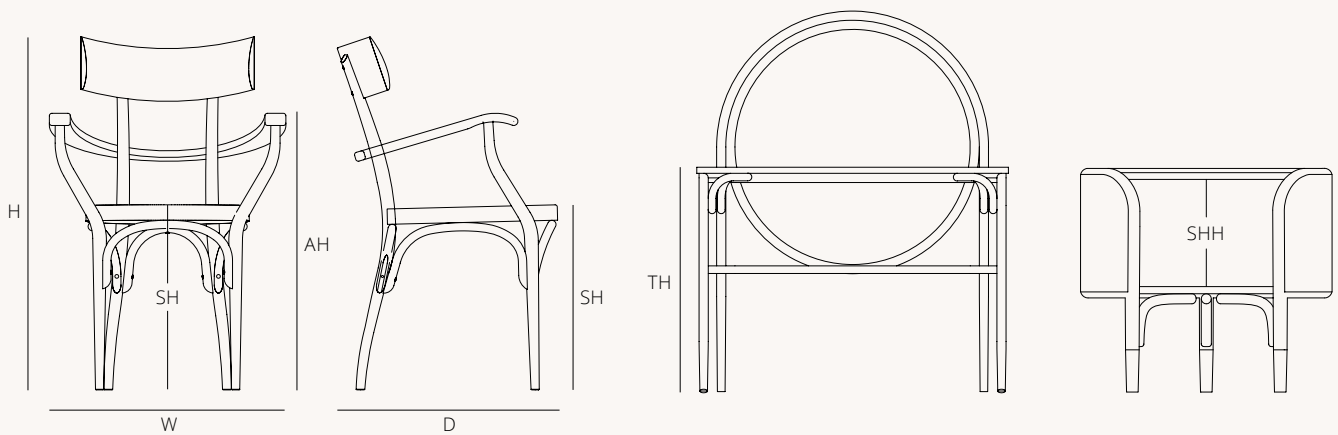

## Key to Dimensions:

H	W	D	SH	AH	TH	SHH
Height	Width	Depth	Seat Height	Arm Height	Top Height	Shelves Height
Höhe	Breite	Tiefe	Sitzhöhe	Höhe Armlehne	Höhe Platte	Höhe der Regale
Altezza	Larghezza	Profondità	Altezza Seduta	Altezza Bracciolo	Altezza Top	Altezza Scaffali
Hauteur	Largeur	Profondeur	Hauteur Assise	Hauteur Accoudoir	Hauteur Top	Hauteur des étagères

**Solid Wood**



**Stains**

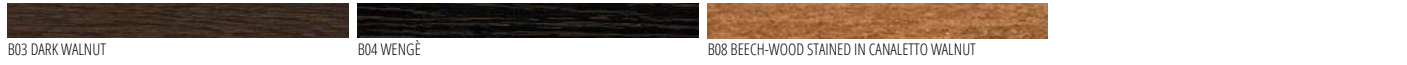

**Classic Lacquer**



**Contemporary Lacquer**

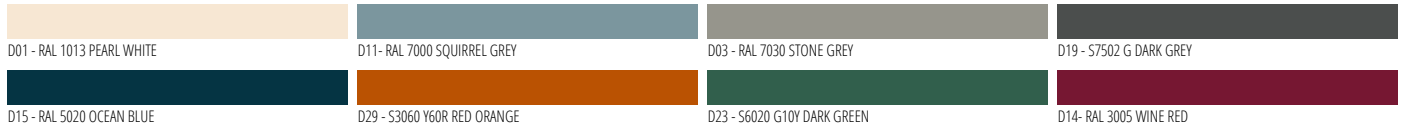

**AMPLE FINISH COMBINATION**

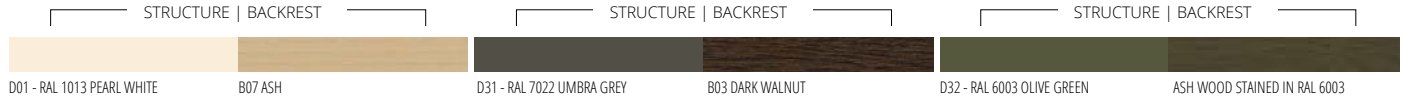

**HAGU FINISH COMBINATION**

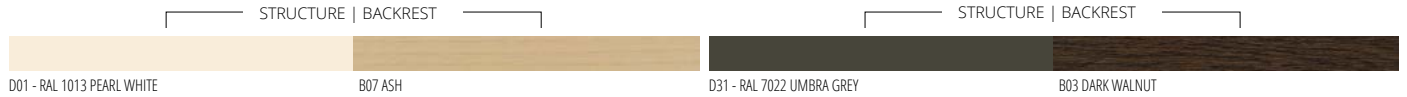

**Laminate Top**

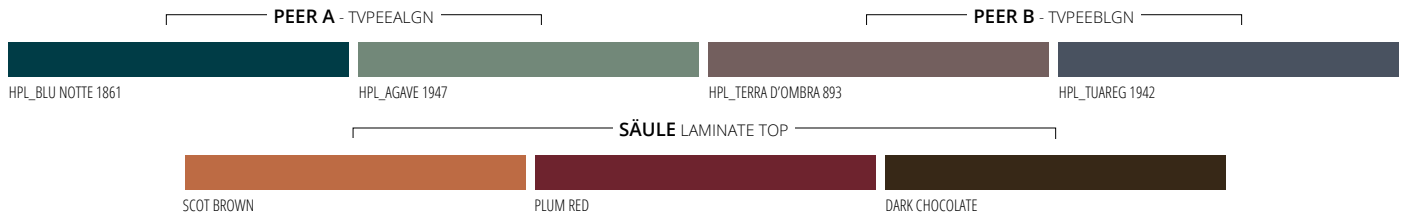

**Caryllon Table Top**



**Tipi Lampshades**



**Wagasa Lampshades**



### AMPLE

Chair with tubular metal frame and ash seat and back. Upholstered or plywood seat. Available in 3 color combinations.

Stuhl mit rohrförmigem Metallgestell und Sitz und Rückenlehne aus Esche. Der Sitz ist aus Holz oder gepolstert erhältlich. In 3 Farbkombinationen erhältlich.

Sedia con struttura in tubolare metallico e con seduta e schienale in frassino. La seduta è disponibile in legno o imbottita. Disponibile in 3 abbinamenti di colore.

Chaise avec cadre métallique tubulaire, siège et dossier en frêne. Le siège est disponible avec assise en contreplaqué ou rembourrée. Disponible en 3 combinaisons de couleurs.

---

#### FINISHES:

##### VERSION 1:

STRUCTURE D01 - RAL 1013 PEARL WHITE / BACKREST B07 ASH

##### VERSION 2:

STRUCTURE D31 - RAL 7022 UMBRA GREY / BACKREST B03 DARK WALNUT

##### VERSION 3:

STRUCTURE D32 - RAL 6003 OLIVE GREEN / BACKREST ASH WOOD OPEN PORE STAINED IN D32 - RAL 6003 OLIVE GREEN



---

#### SDAMPLLGN

Dimensions mm.

H 760 | W 510 | D 510 | SH 450

#### SDAMPLTES

Dimensions mm.

H 760 | W 510 | D 510 | SH 450

## BEAULIEU

Bent beech-wood chair and arm-chair available with plywood or upholstered seat.

Stuhl mit oder ohne Armlehnen aus Buchenbugholz mit Sitz aus Schichtholz oder gepolstert.

Sedia e poltroncina in faggio curvato disponibile con seduta in compensato o imbottita.

Chaise et petit fauteuil en hêtre cintré. Assise en contreplaqué ou rembourrée.

FINISHES:

B01, B03, B04, B08, Classic, Contemporary



SDBEAULGN  
Dimensions mm.  
H 765 | W 505 | D 550 | SH 450

SDBEAUTES  
Dimensions mm.  
H 765 | W 505 | D 550 | SH 450

PTBEAULGN  
Dimensions mm.  
H 765 | W 505 | D 550 | SH 450 | AH 640

PTBEAUTES  
Dimensions mm.  
H 765 | W 505 | D 550 | SH 450 | AH 640

## BISTROTSTUHL

Bent beech-wood armchair.  
Upholstered or plywood seat.

Armstuhl aus Buchenbugholz. Sitz aus Schichtholz oder gepolstert.

Poltroncina in faggio curvato.  
Seduta in multistrato o imbottita.

Petit fauteuil en hêtre cintré. Assise en contreplaqué ou rembourrée.



FINISHES:  
B01, Classic

PTCAFELGN  
Dimensions mm.  
H 770 | W 580 | D 500 | SH 450 | AH 640

PTCAFETES  
Dimensions mm.  
H 770 | W 580 | D 500 | SH 450 | AH 640

## BODYSTUHL

Bent beech-wood chair. 2 versions: woven cane seat and backrest or upholstered seat and woven cane backrest.

Stuhl aus Buchenbugholz. 2 Versionen: Sitz und Rückenlehne aus Wiener Geflecht oder gepolsterter Sitz und Rückenlehne aus Wiener Geflecht.

Sedia in faggio curvato. 2 versioni: seduta e schienale in paglia di Vienna o seduta imbottita e schienale in paglia di Vienna.

Chaise en hêtre cintré. 2 versions: assise et dossier en paille de Vienne ou assise rembourrée et dossier en paille de Vienne.



FINISHES:  
Classic

SDLEHNPL  
Dimensions mm.  
H 800 | W 580 | D 580 | SH 470

SDLEHNTE  
Dimensions mm.  
H 800 | W 580 | D 580 | SH 470

## BREZEL

Bent beech-wood armchair with upholstered seat.

Stuhl aus Buchenbugholz mit gepolsterter Sitz.

Poltroncina in faggio curvato con seduta imbottita.

Petit fauteuil en hêtre cintré avec assise rembourrée.



FINISHES:  
Classic, Contemporary

PLBREZTE1  
Dimensions mm.  
H 770 | W 560 | D 540 | SH 480 | AH 720

## CAFÉSTUHL

Bent beech-wood chair with upholstered or plywood seat.

Stuhl aus Buchenbugholz mit Sitz aus Schichtholz oder gepolstert.

Sedia in faggio curvato, con seduta in multistrato o imbottita.

Chaise en hêtre cintré avec assise en contreplaqué ou rembourrée.



FINISHES:  
B01, Classic

SDCAFELGN  
Dimensions mm.  
H 840 | W 560 | D 510 | SH 460

SDCAFETES  
Dimensions mm.  
H 840 | W 560 | D 510 | SH 460



## CZECH

Bent beech-wood chair and arm-chair, with plywood or upholstered seat. The lacquered version is available with or without natural beech feet.

Sedia e poltroncina in faggio curvato, con seduta in multistrato o imbottita. La versione laccata è disponibile con o senza gambaleto in faggio naturale.

Stuhl aus Buchenbugholz mit oder ohne Armlehnen. Sitz aus Schichtholz oder gepolstert. In der lackierten Ausführung mit oder ohne FüÙe in Buche Natur verfügbar.

Chaise et petit fauteuil en hêtre cintré, avec assise en contreplaqué ou rembourrée; la version laquée est disponible avec ou sans les pieds en hêtre naturel.

FINISHES:  
B01, B03, B04, B08, Classic, Contemporary



SDCZECLGN  
Dimensions mm.  
H 850 | W 420 | D 510 | SH 450



SDCZECTES  
Dimensions mm.  
H 850 | W 420 | D 510 | SH 450



PTCZECLGN  
Dimensions mm.  
H 850 | W 550 | D 510 | SH 450 | AH 680



PTCZECTES  
Dimensions mm.  
H 850 | W 550 | D 510 | SH 450 | AH 680

## GUSTAV

Bent beech-wood stackable chair (max. 4) with plywood seat.

Sedia in faggio curvato, impilabile (Max. 4). Seduta in multistrato.

Stuhl aus Buchenbugholz, stapelbar (Max. 4). Sitz aus Schichtholz.

Chaise en hêtre cintré, empilable (Max. 4). Assise en contreplaqué.



SDGUSTLGN  
Dimensions mm.  
H 780 | W 590 | D 520 | SH 460 | AH 600



Stapelbar (Max. 4)  
Impilabile (Max. 4)  
Stackable (Max. 4)  
Empilable (Max. 4)

FINISHES:  
B01, B03, B04, B08, Classic, Contemporary

## HAGU

Armchair with tubular metal frame and multilayer backrest veneered with ash inside and outside. The seat is upholstered. Available in 2 color combinations.

Sessel mit rohrförmigem Metallgestell und mehrlagiger, innen und außen mit Esche furnierter Rückenlehne. Der Sitz ist gepolstert. In 2 Farbkombinationen erhältlich.

Poltroncina con struttura in tubolare metallico, schienale in multistrato impiallacciato in frassino interno ed esterno. La seduta è imbottita. Disponibile in 2 abbinamenti di colore.

Fauteuil avec cadre tubulaire en métal et dossier en contreplaqué de frêne. Le siège est rembourré. Disponible en 2 combinaisons de couleurs.



FINISHES:  
VERSION 1: structure D01 - RAL 1013 PEARL WHITE / backrest B07 ASH  
VERSION 2: structure D31 - RAL 7022 UMBRA GREY / backrest B03 DARK WALNUT

PTHAGUTES  
Dimensions mm.  
H 780 | W 560 | D 580 | SH 450

## LOOP DINING CHAIR

Bent beech wood dining chair with upholstered seat and wooden backrest.

Esszimmerstuhl aus gebogenem Buchenholz mit gepolstertem Sitz und Holzrückenlehne.

Sedia dining con struttura in faggio curvato. Seduta imbottita e schienale legno di faggio.

Petit fauteuil en hêtre cintré. Assise rembourrée et dossier en bois de hêtre.



FINISHES:  
B01, B03, B04, B08, Classic, Contemporary

PTLOOPPTES  
Dimensions mm.  
H 750 | W 620 | D 550 | SH 450 | AH 700

## LOOS CAFÉ MUSEUM

Bent beech-wood chair with elliptical section. Woven cane, plywood or upholstered seat.

Stuhl aus Buchenbugholz mit elliptischem Schnitt. Sitz aus Wiener Geflecht, Schichtholz oder gepolstert.

Sedia in faggio curvato a sezione ellittica. Seduta in paglia di Vienna, in multistrato o imbottita.

Chaise en hêtre cintré à section à ellipse. Assise en paille de Vienne, en contreplaqué ou rembourrée.



FINISHES:  
B01, B03, B04, B08, Classic

SDLOOSLGN  
Dimensions mm.  
H 870 | W 440 | D 530 | SH 470

SDLOOSPGL  
Dimensions mm.  
H 870 | W 440 | D 530 | SH 470

SDLOOSTES  
Dimensions mm.  
H 870 | W 440 | D 530 | SH 470

## MAGISTRETTI O301

Bent beech-wood armchair. Beech plywood shell, also available with saddle leather covering.

Stuhl aus Buchenbugholz. Sitzschale aus Buchenschichtholz, erhältlich auch mit Lederbezug in den Farben der Kollektion.

Poltroncina in faggio curvato. Scocca in multistrato di faggio disponibile con rivestimento in cuoio nei colori di collezione.

Petit fauteuil en hêtre cintré. Coque en hêtre contreplaqué disponible aussi avec un revêtement en cuir aux couleurs de la collection.



FINISHES:  
B01, B03, B04, B08, Classic, Contemporary

SDMAGILGN  
Dimensions mm.  
H 780 | W 600 | D 600 | SH 450 | AH 610

SDMAGITES  
Dimensions mm.  
H 780 | W 600 | D 600 | SH 450 | AH 610

## MALIT

Armchair with padded structure in flexible cold-foam polyurethane. Base in bent beech-wood. Upholstery in velvet not available.

Sessel in Monocoque-Struktur und Polsterung aus flexiblem, kalt-geschäumtem Polyurethan. Fuß aus Buchenbugholz. Polsterung mit Samt nicht verfügbar.

Poltroncina con struttura monoscocca imbottita in poliuretano flessibile schiumato a freddo. Base in legno di faggio curvato. Rivestimento in velluto non disponibile.

Fauteuil à structure monocoque rembourrée en polyuréthane flexible écumé à froid. Base en bois de hêtre cintré. Rembourrage en velours pas disponible.



FINISHES:  
B01, B03, B04, B08, Classic

PTMALATES  
Dimensions mm.  
H 830 | W 540 | D 540 | SH 450 | AH 680

## MORRIS

Bent beech-wood chair. Upholstered seat and woven cane backrest. Available in two heights.

Stuhl aus Buchenbugholz. Sitz gepolstert, Rückenlehne aus Wiener Geflecht, verfügbar in zwei Höhen.

Sedia in faggio curvato. Seduta imbottita e schienale in paglia di Vienna, disponibile in due altezze.

Chaise en hêtre cintré. Assise rembourrée et dossier en paille de Vienne disponible en deux hauteurs.



FINISHES:  
B01, B03, B04, B08, Classic, Contemporary

SDMORATES  
Dimensions mm.  
H 1120 | W 420 | D 530 | SH 450

SDMORBTES  
Dimensions mm.  
H 840 | W 420 | D 490 | SH 450

## N. 0

Bent beech-wood chair with one armrest. Upholstered seat and back in woven cane or technical net. Also available with 2 armrests or without armrests.

Stuhl mit einer Armlehne aus Buchenbugholz. Gepolsterter Sitz und Rückenlehne aus Wiener Geflecht oder technischem Netz. Auch erhältlich mit 2 Armlehnen oder ohne Armlehnen.

Sedia con un bracciolo in faggio curvato. Sedile imbottito e schienale in paglia di Vienna o in rete tecnica. Disponibile anche con 2 braccioli o senza.

Chaise avec un accoudoir en hêtre cintré. Assise rembourrée et dossier en paille de Vienne ou en résille technique. Également disponible avec 2 accoudoirs ou sans accoudoirs.

FINISHES:  
B01, B03, B04, B08, Classic, Contemporary



SDZEROTES  
Dimensions mm.  
H 870 | W 480 | D 515 | SH 470

SDZEROTEX  
Dimensions mm.  
H 870 | W 525 | D 515 | SH 470 | AH 650

## N. 1

Bent beech-wood chair. Woven cane seat.

Stuhl aus Buchenbugholz. Sitz aus Wiener Geflecht.

Sedia in faggio curvato. Seduta in paglia di Vienna.

Chaise en hêtre cintré. Assise en paille de Vienne.



FINISHES:  
B01, B03, B04, B08, Classic

SDN001PGL  
Dimensions mm.  
H 920 | W 420 | D 490 | SH 470

## N. 14

Bent beech-wood chair. Seat available in wovencane, plywood, perforated plywood or upholstered. Also available in the special version ANNIVERSARIO with a ring-shaped backrest and woven cane seat.

Sedia in faggio curvato. Seduta in paglia di Vienna, in multistrato anche traforato o imbottita. Disponibile nella versione speciale ANNIVERSARIO con schienale in faggio curvato ad anello e seduta in paglia di Vienna.

Stuhl aus Buchenbugholz. Sitz aus Wiener Geflecht, Schichtholz auch mit Lochmuster oder gepolstert. Erhältlich in der speziellen ANNIVERSARIO-Version mit ringgebogener Buche-Rückenlehne und Wiener Strohsitz.

Chaise en hêtre cintré. Assise en paille de Vienne, en contreplaqué aussi ajouré, ou rembourrée. Disponible dans la version spéciale ANNIVERSARIO avec dossier en hêtre cintré et assise en paille de Vienne.



FINISHES:  
B01, B03, B04, B08, Classic, Contemporary

SDN014LGN  
Dimensions mm.  
H 900 | W 410 | D 490 | SH 450

SDN014LGF  
Dimensions mm.  
H 900 | W 410 | D 490 | SH 450

SDN014PGL  
Dimensions mm.  
H 900 | W 410 | D 490 | SH 450



SDN014TES  
Dimensions mm.  
H 900 | W 410 | D 490 | SH 450

SDN014ANN  
Dimensions mm.  
H 900 | W 410 | D 490 | SH 450

## N. 18

Bent beech-wood chair. Plywood or upholstered seat available.

Stuhl aus Buchenbugholz. Sitz aus Schichtholz oder gepolstert.

Sedia in faggio curvato. Seduta in multistrato o imbottita.

Chaise en hêtre cintré. Assise en contreplaqué ou rembourrée.



FINISHES:  
B01, B03, B04, B08, Classic, Contemporary

SDN018LGN  
Dimensions mm.  
H 890 | W 440 | D 490 | SH 470

SDN018TES  
Dimensions mm.  
H 890 | W 440 | D 490 | SH 470

## N. 811

Bent beech-wood chair and armchair. Available in 3 versions: woven cane seat and backrest, upholstered seat and woven cane backrest, upholstered seat and backrest.

Sedia e poltroncina in faggio curvato. Disponibili in 3 versioni: seduta e schienale in paglia di Vienna, seduta imbottita e schienale in paglia di Vienna, seduta e schienale imbottiti.

Stuhl mit oder ohne Armlehnen aus Buchenbugholz. Erhältlich in 3 Versionen: Sitz und Rückenlehne aus Wiener Geflecht, gepolsterter Sitz und Rückenlehne aus Wiener Geflecht, gepolsterter Sitz und Rückenlehne.

Chaise et petit fauteuil en hêtre cintré. Disponibles en 3 versions: assise et dossier en paille de Vienne, assise rembourrée et dossier en paille de Vienne, assise et dossier rembourrés.



FINISHES:  
B01, B03, B04, B08, Classic, Contemporary

SD0811PGL  
Dimensions mm.  
H 820 | W 450 | D 480 | SH 490

SD0811TES  
Dimensions mm.  
H 820 | W 450 | D 480 | SH 490

SD0811TEZ  
Dimensions mm.  
H 820 | W 450 | D 480 | SH 490



PT0811PGL  
Dimensions mm.  
H 820 | W 510 | D 510 | SH 490 | AH 700

PT0811TES  
Dimensions mm.  
H 820 | W 510 | D 510 | SH 490 | AH 700

PT0811TEZ  
Dimensions mm.  
H 820 | W 510 | D 510 | SH 490 | AH 700

## PINCE

Armchair with padded structure and steel insert in flexible coldfoam polyurethane. Legs and back in bent ash-wood.

Poltroncina con struttura monosocca con inserto in acciaio e imbottitura in poliuretano flessibile schiumato a freddo. Gambe e schienale in legno di frassino curvato.

Sessel in Monocoque-Struktur mit Stahleinlage und Polsterung aus flexiblem, kalt-geschäumtem Polyurethan. Beine und Rückenlehne aus Eschenbugholz.

Fauteuil à structure monocoque doté de parties en acier et rembourré en polyuréthane flexible écumé à froid. Pieds et dossier en bois de frêne cintré.



FINISHES:  
B03, B04, B07, Classic

PTPINCTES  
Dimensions mm.  
H 780 | W 560 | D 530 | SH 450 | AH 660

## POST MUNDUS

Bent beech-wood chair. Plywood or upholstered seat available.

Stuhl aus Buchenbugholz. Sitz aus Schichtholz oder gepolstert.

Sedia in faggio curvato. La seduta è disponibile in multistrato o imbottita.

Chaise en hêtre cintré. L'assise est disponible en contreplaqué ou rembourrée.



FINISHES:  
B01, Classic

SDPMUNLGN  
Dimensions mm.  
H 850 | W 480 | D 540 | SH 460

SDPMUNTES  
Dimensions mm.  
H 850 | W 480 | D 540 | SH 460

## POSTSPARKASSE

Bent beech-wood armchair. With perforated plywood or upholstered seat. Only available with aluminium details.

Armstuhl aus Buchenbugholz. Sitz aus Schichtholz mit Lochmuster oder gepolstert. Nur mit Aluminiumdetails erhältlich.

Poltroncina in faggio curvato. La seduta è disponibile in multistrato perforato o imbottita. Disponibile solo con dettagli in alluminio.

Petit fauteuil en hêtre cintré. Assise en contreplaqué ajouré ou rembourrée. Disponible uniquement avec détails en aluminium.

FINISHES:  
B01, B03, B04, B08, Classic



PTPSTKLGA  
With aluminium details  
Dimensions mm.  
H 790 | W 560 | D 590 | SH 470 | AH 790

PTPSTKTEA  
With aluminium details  
Dimensions mm.  
H 790 | W 560 | D 590 | SH 470 | AH 790

## RADETZKY

Bent beech-wood chair with upholstered or plywood seat.

Stuhl aus Buchenbugholz mit Sitz aus Schichtholz oder gepolstert.

Sedia in faggio curvato con seduta in multistrato oppure imbottita.

Chaise en hêtre cintré avec assise en contreplaqué ou rembourrée.



FINISHES:  
B01, B03, B04, B08, Classic, Contemporary

SDRADELGN  
Dimensions mm.  
H 800 | W 520 | D 500 | SH 450

SDRADETES  
Dimensions mm.  
H 800 | W 520 | D 500 | SH 450

## SÖLDEN

Bent beech-wood chair. Upholstered seat and woven cane backrest. Also available with Canaletto walnut structure.

Stuhl aus Buchenbugholz. Sitz gepolstert, Rückenlehne aus Wiener Geflecht. Erhältlich auch mit Gestell aus Canaletto Walnuss.

Sedia in faggio curvato. Seduta imbottita e schienale in paglia di Vienna. Disponibile anche con struttura in noce Canaletto.

Chaise en hêtre cintré. Assise rembourrée et dossier en paille de Vienne. Également disponible avec structure en noix Canaletto.



FINISHES:  
B01, B06, B03, B04, B08, Classic, Contemporary

SDSOLDTES  
Dimensions mm.  
H 840 | W 490 | D 530 | SH 450

SDSONCTES  
Dimensions mm.  
H 840 | W 490 | D 530 | SH 450

## SUGILOO

Bent beech-wood chair and armchair, available in plywood seat or upholstered seat with plywood backrest.

Stuhl und Sessel, erhältlich mit Sitz aus Buchensperrholz oder mit gepolstertem Sitz und Rückenlehne aus Buchensperrholz.

Sedia e poltroncina, disponibile con seduta in multistrato di faggio o con seduta imbottita e schienale in multistrato di faggio.

Chaise et petit fauteuil en hêtre cintré, disponible avec assise en contreplaqué de hêtre ou avec assise rembourrés et dossier en contreplaqué de hêtre.



FINISHES:  
B01, B03, B04, B08, Classic, Contemporary

PTSUGILGN  
Dimensions mm.  
H 820 | W 540 | D 540 | SH 460 | AH 660

PTSUGITE2  
Dimensions mm.  
H 820 | W 540 | D 540 | SH 460 | AH 660

SDSUGILGN  
Dimensions mm.  
H 820 | W 420 | D 470 | SH 460



→ SUGILOO



SDSUGITE2  
Dimensions mm.  
H 820 | W 420 | D 470 | SH 460

VIENNA 144

Bent beech-wood chair. Seat available in woven cane, with stripe pattern plywood, upholstered or upholstered backrest and seat. Only available in the lacquered version.

Stuhl aus Buchenbugholz. Sitz aus Wiener Geflecht, Schichtholz mit Relief, gepolstert oder auch mit gepolsterter Rückenlehne und gepolsterter Sitz. Nur in lackierter Ausführung erhältlich.

Sedia in faggio curvato. Seduta disponibile in paglia di Vienna, in multistrato stampato a rilievo, imbottita o anche con schienale e seduta imbottiti. Disponibile solamente nella finitura laccata.

Chaise en hêtre cintré. Assise disponible en paille de Vienne, contreplaqué avec impression en relief, rembourré ou avec le dossier et l'assise rembourrés. Uniquement disponible en finition laquée.

FINISHES:  
Classic, Contemporary



SDV144LGN  
Dimensions mm.  
H 940 | W 380 | D 550 | SH 450



SDV144PGL  
Dimensions mm.  
H 940 | W 380 | D 550 | SH 450



SDV144TES  
Dimensions mm.  
H 940 | W 380 | D 550 | SH 450



SDV144TE2  
Dimensions mm.  
H 940 | W 380 | D 550 | SH 450

## WIENER STUHL

Bent beech-wood armchair. Woven cane, plywood, perforated plywood, upholstered seat or upholstered seat and backrest available. The frame is also available in two tones (rear legs in natural beech and lacquered structure as per standard collection colors).

Armstuhl aus Buchenbugholz. Sitz aus Wiener Geflecht, gebogenem Schichtholz (auch mit Lochmuster), gepolstert oder Gepolsterte Sitz und Rückenlehne Gestell auch in zweifarbiger Ausführung (Hinterbeinen in Buche Natur und lackierte Struktur in den Farben der Kollektion).

Poltroncina in faggio curvato. La seduta è disponibile in paglia di Vienna, in multistrato curvato anche traforato, imbottita o con seduta e schienale imbottiti. La struttura è disponibile anche bi-color (gambe posteriori in faggio naturale e struttura laccata nei colori di collezione).

Petit fauteuil en hêtre cintré. L'assise est disponible en paille de Vienne, en contreplaqué cintré et même ajouré, rembourrée ou encore avec assise et dossier rembourrés. La structure est aussi disponible bicolore (jambes arrières en hêtre naturel et structure laquée dans les couleurs de la collection).

FINISHES:

ONE TONE: B01, B03, B04, B08, Classic, Contemporary

TWO TONE: Rear Legs: B01

Front legs and frame: Classic, Contemporary



PTWIESLGN  
Dimensions mm.  
H 800 | W 520 | D 570 | SH 470 | AH 710

PTWIESLGF  
Dimensions mm.  
H 800 | W 520 | D 570 | SH 470 | AH 710

PTWIESPGL  
Dimensions mm.  
H 800 | W 520 | D 570 | SH 470 | AH 710

PTWIESTES  
Dimensions mm.  
H 800 | W 520 | D 570 | SH 470 | AH 710

PTWIESTE2  
Dimensions mm.  
H 800 | W 520 | D 570 | SH 470 | AH 710

## STOOLS

### CIRQUE

Bent beech-wood stool in two heights. Barstool version also with backrest. Upholstered or plywood seat available.

Sgabello in faggio curvato disponibile in due altezze. Lo sgabello alto è disponibile anche con schienale. Seduta imbottita oppure in multistrato.

Hocker aus Buchenbugholz in zwei Höhen erhältlich. Barhocker auch mit Rueckenlehne erhältlich. Sitz aus Schichtholz oder gepolstert.

Tabouret en hêtre cintré disponibles en deux hauteurs. Le tabouret bar est également disponible avec un dossier. Assise disponible rembourrée ou en contreplaqué.



FINISHES:  
ONE TONE: B01, B03, B04, B08, Classic, Contemporary  
TWO TONE: C01/C02, B01/B03

SGCIRSLGN  
Dimensions mm.  
H 470 | W 410 | D 410

SGCIRSTES  
Dimensions mm.  
H 470 | W 410 | D 410



SGCIRMLGN  
Dimensions mm.  
H 780 | W 440 | D 440

SGCIRMTES  
Dimensions mm.  
H 780 | W 440 | D 440

SGCIRLLGN  
Dimensions mm.  
H 970 | W 440 | D 440 | SH 780 | AH 970

SGCIRLTES  
Dimensions mm.  
H 970 | W 440 | D 440 | SH 780 | AH 970

### N. 18 BARSTOOL

Bent beech-wood barstool. Plywood or upholstered seat available.

Sgabello da bar in faggio curvato. Seduta in multistrato o imbottita.

Barhocker aus Buchenbugholz. Sitz aus Schichtholz oder gepolstert.

Tabouret bar en hêtre cintré. Assise en contreplaqué ou rembourrée.



FINISHES:  
B01, B03, B04, B08, Classic, Contemporary

SAN018LGN  
Dimensions mm.  
H 1110 | W 415 | D 500 | SH 760

SAN018TES  
Dimensions mm.  
H 1110 | W 415 | D 500 | SH 760

## N. 811 BARSTOOL AND COUNTER

Bent beech-wood barstool and counter. Available in 3 versions: woven cane seat and backrest, upholstered seat and woven cane backrest, upholstered seat and backrest.

Sgabello da bar e counter in faggio curvato. Disponibile in 3 versioni: seduta e schienale in paglia di Vienna, seduta imbottita e schienale in paglia di Vienna, seduta e schienale imbottiti.

Barhocker und Counter Hocker aus Buchenbugholz. Erhältlich in 3 Versionen: Sitz und Rückenlehne aus Wiener Geflecht, gepolsterter Sitz und Rückenlehne aus Wiener Geflecht, gepolsterter Sitz und Rückenlehne.

Tabouret bar et tabouret avec assise h 65 cm en hêtre cintré. Disponible en 3 versions: assise et dossier en paille de Vienne, assise rembourrée et dossier en paille de Vienne, assise et dossier rembourrés.



FINISHES:  
B01, B03, B04, B08, Classic, Contemporary

SA0811PGL  
Dimensions mm.  
H 1085 | W 410 | D 500 | SH 750

SA0811TES  
Dimensions mm.  
H 1085 | W 410 | D 500 | SH 750

SA0811TE2  
Dimensions mm.  
H 1085 | W 410 | D 500 | SH 750



SM0811PGL  
Dimensions mm.  
H 1010 | W 410 | D 500 | SH 650

SM0811TES  
Dimensions mm.  
H 1010 | W 410 | D 500 | SH 650

SM0811TE2  
Dimensions mm.  
H 1010 | W 410 | D 500 | SH 650

## POSTSPARKASSE HOCKER

Bent beech-wood stool with perforated plywood seat. Visible metal details.

Sgabello in faggio curvato. Seduta in multistrato traforato. Dettagli metallici a vista.

Hocker aus Buchenbugholz. Sitz aus perforiertem Schichtholz. Mit Zierbeschlägen aus Metall.

Tabouret en hêtre cintré. Assise en contreplaqué perforé. Détails apparents en métal.



FINISHES:  
B01, B03, B04, B08, Classic

SGPSTKLGN  
Dimensions mm.  
H 480 | W 420 | D 420

## STOOLS

### SINGLE CURVE BARSTOOL

Bent beech-wood barstool. Woven cane or plywood seat available. Brass covered footrest.

Barhocker aus Buchenbugholz. Sitz aus Wiener Geflecht oder Schichtholz. Fußstütze mit Messing beschichtet.

Sgabello da bar in faggio curvato. La seduta è disponibile in paglia di Vienna o in multistrato. Barra poggiapiedi rivestita in ottone.

Tabouret bar en hêtre cintré. L'assise est disponible en paille de Vienne ou en contreplaqué. Barre repose-pied recouverte de laiton.



FINISHES:  
B01, B03, B04, B08, Classic, Contemporary

SANSTOPGL  
Dimensions mm.  
H 870 | W 540 | D 420 | SH 740 | AH 870

SANSTOLGN  
Dimensions mm.  
H 870 | W 540 | D 420 | SH 740 | AH 870

### SINGLE CURVE COUNTER

Bent beech-wood counter stool. Woven cane or plywood seat available. Brass covered footrest.

Counter Hocker aus Buchenbugholz. Sitz aus Wiener Geflecht oder Schichtholz. Fußstütze mit Messing beschichtet.

Sgabello counter in faggio curvato. La seduta è disponibile in paglia di Vienna o in multistrato. Barra poggiapiedi rivestita in ottone.

Tabouret bar en hêtre cintré, assise h 65 cm. L'assise est disponible en paille de Vienne ou en contreplaqué. Barre repose-pied recouverte de laiton.



FINISHES:  
B01, B03, B04, B08, Classic, Contemporary

SMNSTOLGN  
Dimensions mm.  
H 780 | W 540 | D 420 | SH 650 | AH 780

SMNSTOPGL  
Dimensions mm.  
H 780 | W 540 | D 420 | SH 650 | AH 780

### SINGLE CURVE STOOL

Bent beech-wood three-leg stool. Woven cane or plywood seat.

Dreibeiniger Hocker aus Buchenbugholz. Sitz aus Wiener Geflecht oder Schichtholz.

Sgabello a tre gambe. La seduta è in paglia di Vienna o in multistrato.

Tabouret à trois pieds en hêtre cintré. Assise en paille de Vienne ou en contreplaqué.



FINISHES:  
B01, B03, B04, B08, Classic, Contemporary

SBNSTOPGL  
Dimensions mm.  
H 690 | W 480 | D 430 | SH 480 | AH 690

SBNSTOLGN  
Dimensions mm.  
H 690 | W 480 | D 430 | SH 480 | AH 690

## STOOLS

### TRIO

Bent beech-wood stool in three heights: bar, counter and low. Upholstered or plywood seat.

Hocker aus Buchenbugholz in drei Höhen erhältlich: Bar, Counter oder klein. Sitz gepolstert oder aus Schichtholz.

Sgabello in faggio curvato disponibile in tre altezze: bar, counter e basso. Seduta imbottita o in multistrato.

Tabourets en hêtre cintré disponibles en trois hauteurs: assise h.77 cm ou h. 65 cm ou bas. Assise rembourrée ou en contreplaqué.

FINISHES:  
B01, B03, B04, B08, Classic, Contemporary



SATRIOLGN  
Dimensions mm.  
H 770 | W 440 | D 440



SATRIOTES  
Dimensions mm.  
H 770 | W 440 | D 440



SMTRIOLGN  
Dimensions mm.  
H 650 | W 440 | D 440



SMTRIOTES  
Dimensions mm.  
H 650 | W 440 | D 440



SBTRIOLGN  
Dimensions mm.  
H 460 | W 400 | D 380



SBTRIOTES  
Dimensions mm.  
H 460 | W 400 | D 380

### VIENNA 144 STOOLS

Bent beech-wood stool, available in 2 heights. Woven cane, stripe pattern plywood or upholstered seat available. Only for the higher version, footrest comprising a chromed metal ringshaped element.

Hocker aus Buchenbugholz in zwei Höhen. Sitz aus Wiener Geflecht, Schichtholz mit Relief oder gepolstert. Nur für höhere Version mit verchromtem Metallring als Fußstütze.

Sgabello in faggio curvato, in due altezze. La seduta è disponibile in paglia di Vienna, in multistrato stampato a rilievo o imbottita. Solo per la versione alta, poggiatesta costituito da un elemento ad anello in metallo cromato.

Tabouret en hêtre cintré, en deux hauteurs. L'assise est disponible en paille de Vienne, en contreplaqué imprimé en relief ou rembourrée. Uniquement pour la version la plus haute, repose-pieds constitué d'un élément en forme d'anneau en métal chromé.

FINISHES:  
B01, B03, B04, B08, Classic, Contemporary



SAV144LGN  
Dimensions mm.  
H 850 | W 460 | D 460



SAV144PGL  
Dimensions mm.  
H 850 | W 460 | D 460



SAV144TES  
Dimensions mm.  
H 850 | W 460 | D 460



SBV144LGN  
Dimensions mm.  
H 450 | W 350 | D 350



SBV144PGL  
Dimensions mm.  
H 450 | W 350 | D 350



SBV144TES  
Dimensions mm.  
H 450 | W 350 | D 350

## BENCHES

### COAT RACK BENCH

Coat rack bench with bent beech-wood frame. Woven cane or upholstered seat.

Bank mit Kleiderständer. Gestell aus Buchenbugholz mit Sitz aus Wiener Geflecht oder Gepolsterte.

Panca appendiabiti con struttura in faggio curvato e seduta in paglia di Vienna o imbottita.

Banc porte-manteaux avec structure en hêtre cintré et assise en paille de Vienne ou rembourrée.



FINISHES:  
Classic

PCCOATPGL  
Dimensions mm.  
H 1880 | W 1360 | D 590 | SH 440

PCCOATTES  
Dimensions mm.  
H 1880 | W 1360 | D 590 | SH 440

### MOS BENCH

Bench with bent beech-wood frame and woven cane inserts. Open-pore painted shelves in ash veneer. Upholstered seat with removable cover. Brass feet

Sitzbank mit dampfgebogenem Buchenholzgestell und eingesetztem Wiener Geflecht. Regale aus offporigem, lackiertem Eschefurnier. Gepolsterter Sitz mit abnehmbarem Bezug. Messing-Füßen.

Panca con struttura in faggio curvato a vapore e inserti in paglia di Vienna. Ripiani in impiallacciato in frassino verniciato a poro aperto. Seduta imbottita sfoderabile. Puntali in ottone.

Banc avec structure en hêtre cintré et inserts en paille de Vienne. Étagères en plaqué frêne teinté à pores ouverts. Assise rembourrée déhoussable. Pieds en laiton.



FINISHES:  
FRAME B01, C01  
SHELVE B07, C01

PCMSGTEP  
Dimensions mm.  
H 440 | W 1360 | D 430 | SH 370 | SHH 140

PCMSGTEP + PWMOSGTE2  
Dimensions mm.  
H 440 | W 1360 | D 430 | SH 440 | SHH 140

PCMSGTEP + PWMOSGTES  
Dimensions mm.  
H 440 | W 1360 | D 430 | SH 440 | SHH 140

## CHIGNON

Lounge chair with bent beech-wood frame. Seat and back in polyurethane foam of different densities and polyester fiber.

Poltrona lounge con struttura in faggio curvato. Seduta e schienale in poliuretano espanso a densità differenziate e fibra poliester.

Loungesessel mit Gestell aus Buchenbugholz. Sitz und Rückenlehne aus Polyurethan Schaumstoff unterschiedlicher Dichte und Polyesterfaser.

Fauteuil lounge avec structure en hêtre cintré. Assise et dossier en polyurethane expansé à densité différenciée et fibre de polyester.



FINISHES:  
B01, B03, B04, B08, Classic, Contemporary

PTCHIGTES  
Dimensions mm.  
H 740 | W 920 | D 820 | SH 450

## HIDEOUT

Bent beech-wood lounge chair and two-seater sofa. Upholstered seat and backrest with different density polyurethane foam filling and side elements in woven cane.

Poltrona lounge e divano a due posti in faggio curvato. Seduta e schienale imbottiti in poliuretano espanso a densità differenziata con elementi laterali in paglia di Vienna.

Loungesessel und Zweisitzer-Sofa aus Buche. Sitz und Rückenlehne mit Polsterung aus Schaumstoff mit unterschiedlichen Härtegraden, Seitenelemente aus Wiener Geflecht.

Fauteuil lounge et canapé deux places en hêtre cintré. Assise et dossier rembourrés en polyurethane à densité différenciée avec éléments latéraux en paille de Vienne.



FINISHES:  
B01, C01

PLHIDETES  
Dimensions mm.  
H 1170 | W 740 | D 740 | SH 390

DBHIDETES  
Dimensions mm.  
H 1170 | W 1460 | D 830 | SH 390



## JANNIS

Collection of upholstered items with bent beech-wood frame and brass decorative elements. Fully removable cover. Upholstered seat with different density polyurethane foam filling, covered with acrylic fiber layers. Cushions made of polyurethane memory foam.

Kollektion von gepolsterten Produkte mit Buchholzgestell aus Buche und Dekoelementen aus Messing. Vollständig abnehmbarer Bezug. Sitzpolsterung aus PU-Schaumstoff mit unterschiedlichen Härtegraden, Bezug aus Acrylfaser. Kissen aus Polyurethanschaum mit Formgedächtnis hergestellt.

Collezione di imbottiti con struttura in faggio curvato ed elementi decorativi in ottone, completamente sfoderabile. Seduta imbottita in poliuretano espanso a densità differenziata, rivestito con falde di fibre acriliche. Cuscini in poliuretano espanso memory foam.

Collection de produits rembourrés avec structure en hêtre cintré et éléments décoratifs en laiton. Complètement déhoussable. Assise rembourrés en mousse de polyuréthane à densité différenciée, recouvert de bandes de fibres acryliques. Coussins en polyuréthane à mousse de mémoire.

FINISHES:  
B01, C01



DJANNTES  
Dimensions mm.  
H 820 | W 2080 | D 800 | SH 420 | AH 610



DBJANNTES  
Dimensions mm.  
H 820 | W 1450 | D 800 | SH 420 | AH 610



PJANNTES  
Dimensions mm.  
H 820 | W 770 | D 800 | SH 420 | AH 610

## LEHNSTUHL

Bent beech-wood lounge chair. Available in three versions: large mesh woven cane seat and backrest, upholstered seat and large mesh woven cane backrest or fully upholstered. Bent beech-wood footrest with wide mesh woven cane or upholstered.

Lehnstuhl aus Buchenbugholz. Erhältlich in drei Versionen: Sitz und Rückenlehne aus weitmaschigem Wiener Geflecht, gepolsterter Sitz und Rückenlehne aus weitmaschigem Wiener Geflecht oder beide gepolstert. Fußstütze aus Buchenbugholz und weitmaschigem Wiener Geflecht oder gepolstert.

Lounge chair in faggio curvato. Disponibile in tre versioni: seduta e schienale in paglia di Vienna a maglia larga, seduta imbottita e schienale in paglia di Vienna a maglia larga o tutta imbottita. Poggiapiedi in faggio curvato con paglia di Vienna a maglia larga o imbottito.

Fauteuil lounge en hêtre cintré. Disponible en trois versions: assise et dossier en paille de Vienne à maille large, assise rembourrée et dossier en paille de Vienne à maille large, assise et dossier rembourrés. Repose-pied en hêtre cintré avec paille de Vienne à maille large ou rembourré.

FINISHES:  
C01, D03



PLLEHNPGL  
Dimensions mm.  
H 840 | W 740 | D 830 | SH 410 | AH 570



PLLEHNTES  
Dimensions mm.  
H 840 | W 740 | D 830 | SH 410 | AH 570



PLLEHTSS  
Dimensions mm.  
H 840 | W 740 | D 830 | SH 410 | AH 570



PPLEHNPGL  
Dimensions mm.  
H 420 | W 590 | D 410



PPLEHNTES  
Dimensions mm.  
H 420 | W 590 | D 410

## LOÏE

Lounge chair with woven cane or technical net backrest and elliptical frame in bent solid ash. Metal frame with black powdered lacquer. Seat with fabric woven straps. Upholstered in differentiated density polyurethane foam and goose down.

Armsessel mit Rückenlehne aus Wiener Geflecht oder technischem Netz. Struktur aus gebogenem Eschenholz und Metallsockel. Gepolsterter Sitz.

Poltroncina con schienale in paglia di Vienna o in rete tecnica, struttura in frassino curvato e base in metallo. Seduta imbottita.

Fauteuil avec dossier en paille de Vienne ou en résille technique, structure en frêne cintré et base en métal. Assise rembourrée.



PLLOIETES  
Dimensions mm.  
H 940 | W 700 | D 740 | SH 420



PLLOIETEX  
Dimensions mm.  
H 940 | W 700 | D 740 | SH 420

FINISHES:  
B03, B07, C01

## LOOP LOUNGE AND BANQUETTE

Bent beech-wood lounge chair and banquette with upholstered seat and back. The roller backrest is fully removable.

Poltroncina e banquette in faggio curvato con seduta e schienale imbottiti. Lo schienale a rullo è interamente sfoderabile.

Sessel und Bank aus gebogener Buche mit gepolsterten Sitz und Rückenlehne. Die Rückenlehne ist vollständig abnehmbar.

Fauteuil et banquette en hêtre cintré avec assise et dossier rembourrés. Le dossier est entièrement amovible.



FINISHES:  
B01, B03, B04, B08, Classic, Contemporary

PTLOOPTES  
Dimensions mm.  
H 735 | W 650 | D 660 | SH 450 | AH 650

DQLOOPTEZ  
Dimensions mm.  
H 770 | W 1450 | D 620 | SH 450 | AH 650

## LUFTBALLON

Collection of upholstered items with bent beech-wood frame. Fully removable cover. Upholstered seat with different density in fireretardant polyurethane foam filling, covered with acrylic fiber layers. Cushions made of polyurethane memory foam. Characterized by the "French stitching", a stylistic hallmark of the collection.

Kollektion von gepolsterten Produkte mit Bugholzgestell aus Buche. Vollständig abnehmbarer Bezug. Sitzpolsterung aus PUSchaumstoff mit feuerhemmendem unterschiedlichen Härtegraden, Bezug aus Acrylfaser. Kissen aus Polyurethanschaum mit Formgedächtnis hergestellt. Gezeichnet durch die „französische Naht“, ein stilistisches Markenzeichen der Kollektion.

Collezione di imbottiti con struttura in faggio curvato, completamente sfoderabili. Seduta imbottita in poliuretano espanso ignifugo a densità differenziata, rivestito con falde di fibre acriliche. Cuscini in poliuretano espanso memory foam. Caratterizzati dalla "cucitura francese", cifra stilistica delle collezione.

Collection de produits rembourrés avec structure en hêtre cintré. Complètement déhoussable. Assise rembourrés en mousse de polyurethane ignifugée à densité différenciée, recouvert de bandes de fibres acryliques. Coussins en polyuréthane à mousse de mémoire. Caractérisé par les coutures apparentes, marque stylistique de la collection.

FINISHES:  
B01, B03, B04, B08, Classic, Contemporary



DLLUFFTES  
Dimensions mm.  
H 770 | W 1930 | D 800 | SH 450

DBLUFFTES  
Dimensions mm.  
H 770 | W 1530 | D 800 | SH 450

PLLUFFTES  
Dimensions mm.  
H 770 | W 930 | D 800 | SH 450

## MICKEY

Lounge chair with bent beech-wood frame. Seat and back in polyurethane foam of different densities and polyester fiber.

Poltrona lounge con struttura in faggio curvato. Seduta e schienale in poliuretano espanso a densità differenziate e fibra poliestere.

Loungesessel mit Gestell aus Buchenbugholz. Sitz und Rückenlehne aus Polyurethan Schaumstoff unterschiedlicher Dichte und Polyesterfaser.

Fauteuil lounge avec structure en hêtre cintré. Assise et dossier en polyurethane expansé à densité différenciée et fibre de polyester.

FINISHES:  
B01, C01



PLMICKTES  
Dimensions mm.  
H 1220 | W 970 | D 765 | SH 450 | AH 650

## N. 200

Bent beech-wood lounge chair. Woven cane or upholstered seat and backrest.

Loungesessel aus Buchenbugholz. Sitz und Rückenlehne aus Wiener Geflecht oder gepolstert.

Poltrona lounge in faggio curvato. Seduta e schienale in paglia di Vienna o imbottiti.

Fauteuil lounge en hêtre cintré. Assise et dossier en paille de Vienne ou rembourrés.



FINISHES:  
B01, C01

PLN200PGL  
Dimensions mm.  
H 730 | W 630 | D 775 | SH 425 | AH 615

PLN200TES  
Dimensions mm.  
H 730 | W 630 | D 775 | SH 425 | AH 615

## PROMENADE

Collection of upholstered items with removable covers, canaletto walnut frames with square section profiles. Backrest panels covered with fabric, also available with a woven cane trim on the upper part. Upholstered in differentiated-density polyurethane foam and goose down.

Kollektion an Polstermöbeln mit herausnehmbaren Polsterzeug und einer Struktur aus Canaletto Walnuss. Profile mit quadratischem Querschnitt. Rückenpartien mit Stoff bezogen, auch mit einer Umrandung aus Wiener Geflecht im oberen Bereich erhältlich. Polsterung aus aufgeschäumten Polyurethan unterschiedlicher Dicke und Gänsedaunen.

Collezione di imbottiti sfoderabili con struttura in noce canaletto, profili a sezione quadrata. Pannelli schienale rivestiti in tessuto, disponibili anche con inserto in paglia di Vienna nella fascia superiore. Imbottitura in poliuretano espanso a densità differenziata e piuma d'oca.

Collection d'articles rembourrés déhoussables avec une structure en noyer canaletto, profiles section carrée. Panneaux dossier tapissés, également disponibles avec une bordure en paille de Vienne au niveau de la bande supérieure. Rembourrage en mousse polyuréthane à densité différenciée et en duvet d'oie.

FINISHES:  
B06



DBPROMTES  
Dimensions mm.  
H 840 | W 1800 | D 900 | SH 400 | AH 690



DLPROMTES  
Dimensions mm.  
H 840 | W 2300 | D 900 | SH 400 | AH 690



PLPROMTES  
Dimensions mm.  
H 680 | W 800 | D 800 | SH 400 | AH 690

## SCHAUKELSTUHL

Bent beech-wood rocking chair. Woven cane seat and backrest.

Schaukelstuhl aus Buchenbugholz. Sitz und Rückenlehne aus Wiener Geflecht.

Dondolo in faggio curvato. Seduta e schienale in paglia di Vienna.

Chaise à bascule en hêtre cintré. Assise et dossier en paille de Vienne.



FINISHES:  
B01, B03, B04, B08, Classic

DNSCHAPGL  
Dimensions mm.  
H 1040 | W 520 | D 1040 | SH 490

## SUZENNE

Two-seater sofa and lounge chair with bent beech-wood frame and woven cane inserts. Upholstered seat and backrest.

Zweisitzer-Sofa und Loungesessel mit dampfgebogenem Buchenholzgestell und eingesetztem Wiener Geflecht. Sitz und Rückenlehne gepolstert.

Divano due posti e lounge chair con struttura in faggio curvato a vapore e inserti in paglia di Vienna. Seduta e schienale imbottiti.

Canapé deux places et fauteuil lounge avec structure en hêtre cintré et inserts en paille de Vienne. Assise et dossier rembourrés.



FINISHES:  
C01

DBSUZETES  
Dimensions mm.  
H 820 | W 1480 | D 780 | SH 430

PLSUZETES  
Dimensions mm.  
H 820 | W 850 | D 780 | SH 430

## TARGA

Collection of upholstered items with bent beech-wood frame and woven cane decorative elements. Seat and backrest with different density polyurethane foam filling, covered with acrylic fiber layers. Also available with brass feet.

Kollektion von gepolsterten Produkte mit Bugholzgestell aus Buche und Dekoelementen aus Wiener Geflecht. Polsterung von Sitz und Rückenlehne aus PU-Schaumstoff mit unterschiedlichen Härtegraden, Bezug aus Acrylfaser. Erhältlich auch mit Messing-Füßen.

Collezione di imbottiti con struttura in faggio curvato ed elementi decorativi in paglia di Vienna. Seduta e schienale imbottiti in poliuretano espanso a densità differenziata, rivestito con falde di fibre acriliche. Disponibile anche con piedini in ottone.

Collection de produits rembourrés avec structure en hêtre cintré et éléments décoratifs en paille de Vienne. Assise et dossier rembourrés en mousse de polyuréthane à densité différenciée, recouvert de bandes de fibres acryliques. Également disponible avec pieds en laiton.

FINISHES:  
B01, C01



DBTARGTES  
Dimensions mm.  
H 760 | W 1600 | D 840 | SH 400

DBTARGTEP with brass feet  
Dimensions mm.  
H 810 | W 1600 | D 840 | SH 450

DLTARGTES  
Dimensions mm.  
H 760 | W 2000 | D 840 | SH 400

DLTARGTEP with brass feet  
Dimensions mm.  
H 810 | W 2000 | D 840 | SH 450

PLTARGTES  
Dimensions mm.  
H 760 | W 930 | D 840 | SH 400

PLTARGTEP with brass feet  
Dimensions mm.  
H 810 | W 930 | D 840 | SH 450



CORNER UNIT, 2018  
DMTARGTAN  
Dimensions mm.  
H 760 | W 750 | D 750 | SH 400

CENTRAL UNIT, 2018  
DMTARGTCE  
Dimensions mm.  
H 760 | W 1000 | D 780 | SH 400

LEFT END UNIT, 2018  
DMTARGTSX  
Dimensions mm.  
H 760 | W 1000 | D 780 | SH 400

RIGHT END UNIT, 2018  
DMTARGTDX  
Dimensions mm.  
H 760 | W 1000 | D 780 | SH 400

DMTARGPAN with brass feet  
Dimensions mm.  
H 810 | W 750 | D 750 | SH 450

DMTARGPCE with brass feet  
Dimensions mm.  
H 810 | W 1000 | D 780 | SH 450

DMTARGPSX with brass feet  
Dimensions mm.  
H 810 | W 1000 | D 780 | SH 450

DMTARGPDX with brass feet  
Dimensions mm.  
H 810 | W 1000 | D 780 | SH 450

## MOS BOOKCASE

Freestanding bookcase with bent beech-wood frame and woven cane lateral inserts. Open pore painted shelves in ash veneer. Brass feet.

Libreria "freestanding" con struttura in faggio curvato e inserti laterali in paglia di Vienna. Ripiani in impiallacciato frassino verniciato a poro aperto. Puntali in ottone.

"Freestanding" Bücherregal mit Buchenbugholzgestell und Seiteneinsätze aus Wiener Geflecht. Regale aus of-fenporigem, lackiertem Eschefurnier. Messing-Füßen.

"Freestanding" bibliothèque avec structure en hêtre cintré et inserts latéraux en paille de Vienne. Étagères en plaqué frêne teinté à pores ouverts. Pieds en laiton.



FINISHES:  
B01, B07, C01

LBMOSEGGL  
Dimensions mm.  
H 1430 | W 1360 | D 430 | SHH 290

## MOS CABINET

Cabinet with bent beech-wood frame and woven cane lateral and rear panel. Woven cane doors with magnetic closure. Open pore painted shelves in ash veneer. Brass feet.

Cabinet con struttura in faggio curvato e pannelli laterali e posteriori in paglia di Vienna. Ante con chiusura magnetica in paglia di Vienna. Ripiani impiallacciati in frassino verniciato a poro aperto. Puntali in ottone.

Schrank mit Buchenbugholzgestell und Seiten- und Rückwänden aus Wiener Geflecht. Türen aus Wiener Geflecht und Magnetverschluss. Regale aus of-fenporigem, lackiertem Eschefurnier. Messing-Füßen.

Cabinette avec structure en hêtre cintré et panneaux latéraux et arrière en paille de Vienne. Portes avec fermeture aimantée en paille de Vienne. Étagères en plaqué frêne teinté à pores ouverts. Pieds en laiton.



FINISHES:  
B01, B07, C01

CNMOSAPGC  
Dimensions mm.  
H 910 | W 1360 | D 430 | SHH 290

## MOS CONSOLE

Console with bent beech-wood frame and woven cane lateral and rear panel. Open pore painted shelves in ash veneer. Brass feet.

Console con struttura in faggio curvato e pannelli laterali e posteriori in paglia di Vienna. Ripiani impiallacciati in frassino verniciato a poro aperto. Puntali in ottone.

Schrank mit Buchenbugholzgestell und Seiten- und Rückwänden aus Wiener Geflecht. Regale aus of-fenporigem, lackiertem Eschefurnier. Messing-Füßen.

Console avec structure en hêtre cintré et panneaux latéraux et arrière en paille de Vienne. Étagères en plaqué frêne teinté à pores ouverts. Pieds en laiton.



FINISHES:  
B01, B07, C01

CNMOSGPGC  
Dimensions mm.  
H 910 | W 1360 | D 430 | SHH 290

## NYNY DRAWERS

Storage unit made up of two modules in lacquered wood with decorative elements in woven cane. The modules are suspended thanks to the metal structure, with satin brass finish, to be fixed to the wall.

Mobile contenitore composto da due moduli in legno laccato con elementi decorativi in paglia di Vienna. I moduli sono sospesi grazie alla struttura in metallo, con finitura in ottone satinato, da fissare a parete.

Schrank bestehend aus zwei Modulen aus lackiertem Holz mit dekorativen Elementen aus Wiener Geflecht. Die Module sind dank der an der Wand zu befestigenden Metallstruktur mit satiniertem Messing-Ausführung aufgehängt.

Meuble de rangement composé de deux modules en bois laqué avec éléments décoratifs en paille de Vienne. Les modules sont suspendus grâce à la structure métallique, finition laiton satiné, à fixer au mur.



FINISHES:  
C01, D29, D23

MCNNYCS1  
Dimensions mm.  
H 750 | W 900 | D 450

## NYNY SIDEBOARD

Storage unit made up of six modules in lacquered wood with decorative elements in woven cane. The modules are suspended thanks to the metal structure, with satin brass finish, to be fixed to the wall.

Mobile contenitore composto da sei moduli in legno laccato con elementi decorativi in paglia di Vienna. I moduli sono sospesi grazie alla struttura in metallo, con finitura in ottone satinato, da fissare a parete.

Schrank bestehend aus sechs Modulen aus lackiertem Holz mit dekorativen Elementen aus Wiener Geflecht. Die Module sind dank der an der Wand zu befestigenden Metallstruktur mit satiniertem Messing-Ausführung aufgehängt.

Meuble de rangement composé de six modules en bois laqué avec éléments décoratifs en paille de Vienne. Les modules sont suspendus grâce à la structure métallique, finition laiton satiné, à fixer au mur.



FINISHES:  
C01, D29, D23

MCNNYC31  
Dimensions mm.  
H 750 | W 2710 | D 450

## NYNY UNIT

Storage unit made up of four overlapping modules in lacquered wood with decorative elements in woven cane. The modules are suspended thanks to the metal structure, with satin brass finish, to be fixed to the wall.

Mobile contenitore composto da quattro moduli sovrapposti in legno laccato con elementi decorativi in paglia di Vienna. I moduli sono sospesi grazie alla struttura in metallo, con finitura in ottone satinato, da fissare a parete.

Schrank bestehend aus vier überlappenden Modulen aus lackiertem Holz mit dekorativen Elementen aus Wiener Geflecht. Die Module sind dank der an der Wand zu befestigenden Metallstruktur mit satiniertem Messing-Ausführung aufgehängt.

Meuble de rangement composé de quatre modules superposés en bois laqué avec éléments décoratifs en paille de Vienne. Les modules sont suspendus grâce à la structure métallique, finition laiton satiné, à fixer au mur.



FINISHES:  
C01, D29, D23

MCNNYTM1  
Dimensions mm.  
H 2000 | W 1650 | D 450



## HEADBOARDS

Upon request it is available the bed base with removable fabric and wooden slats, dimensions mm H 320 | W 1600 | D 2000

### OTTOW

Headboard with bent beech-wood and woven cane decoration. Central element in perforated wood. Brass details in the black lacquered version. Copper details in the natural stained version.

Testiera con struttura in faggio curvato e decoro in paglia di Vienna. Elemento centrale in legno traforato. Dettagli in ottone nella versione laccata nera e in rame in quella tinta naturale.

Kopfteilstruktur aus Buchenbugholz und Dekoration aus Wiener Geflecht. Zentralelement in perforiertem Holz. Messingdetails in schwarz lackierter Ausführung. Kupferdetails in Natur gebeizter Ausführung.

Tête de lit avec structure en hêtre cintré et décor en paille de Vienne. Élément central en bois perforé. Détails en laiton dans la version laquée noire et en cuivre dans la version teintée naturelle.



FINISHES:  
B01, C01

HBOTTOPGL  
Dimensions mm.  
H 1300 | W 2420 | D 72

### RUE

Headboard with bent beech-wood and woven cane decoration. Central element in woven cane or upholstered with removable cover. The cover in leather is not removable.

Testiera con struttura in faggio curvato e decoro in paglia di Vienna. Elemento centrale in paglia di Vienna o con imbottitura sfoderabile. Il rivestimento in pelle non è sfoderabile.

Kopfteilstruktur aus Buchenbugholz und Dekoration aus Wiener Geflecht. Zentralelement aus Wiener Geflecht oder mit abnehmbarem Bezug. Der Bezug aus Leder ist nicht abnehmbar.

Tête de lit avec structure en hêtre cintré et décor en paille de Vienne. Élément central en paille de Vienne ou rembourré déhoussable. Le rembourrage en cuir n'est pas déhoussable.



FINISHES:  
B01, C01, D03

HBRUEGTES  
Dimensions mm.  
H 730 | W 2500 | D 150

HBRUEGPGL  
Dimensions mm.  
H 730 | W 2500 | D 150

### YVETTE

Headboard with bent beech-wood and metal tubular frame. Woven cane decoration. Upholstered central element with removable cover. The cover in leather is not removable.

Testiera con struttura in faggio curvato e tubolare metallico, decoro in paglia di Vienna. Elemento centrale con imbottitura sfoderabile. Il rivestimento in pelle non è sfoderabile.

Kopfteilstruktur aus Buchenbugholz und Metallrohr, Dekoration mit Wiener Geflecht. Gepolstertes Zentralelement mit abnehmbarem Bezug. Der Bezug aus Leder ist nicht abnehmbar.

Tête de lit avec structure en hêtre cintré et tubulaire en métal, décor en paille de Vienne. Élément central rembourré déhoussable. Le rembourrage en cuir n'est pas déhoussable.

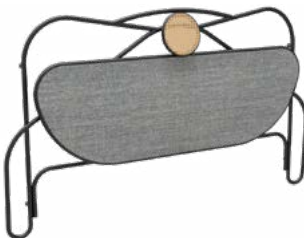

FINISHES:  
B03, C01

HBVETTES  
Dimensions mm.  
H 1210 | W 2100 | D 110

## ARCH DINING TABLE

Table with bent beech-wood frame and open pore painted ash-wood veneer top. Available in two sizes.

Tisch mit Gestell aus Buchenbugholz und Tischplatte aus offenporig lackierter furnierter Esche. In zwei Größen verfügbar.

Tavolo con struttura in faggio curvato e piano impiallacciato in frassino verniciato a poro aperto. Disponibile in due dimensioni.

Table avec structure en hêtre cintré et plateau en plaqué frêne verni à pores ouverts. Disponible en deux dimensions.

### FINISHES:

TWO TONE | VERSION 1:  
Ash-Wood Top: C01  
Beech-Wood Legs: B03  
Beech-Wood Arches: C01

TWO TONE | VERSION 2:  
Ash-Wood Top: C02  
Beech-Wood Legs: B01  
Beech-Wood Arches: C02

TWO TONE | VERSION 3:  
Ash-Wood Top: B07  
Beech-Wood Legs: B01  
Beech-Wood Arches: B07

ONE TONE:  
Ash-Wood Top And Beech-Wood Frame:  
B03, B04, Classic, Contemporary



TVDT22LGN  
Dimensions mm.  
H 740 | W 2200 | D 1000



TVDT18LGN  
Dimensions mm.  
H 740 | W 1800 | D 1000

## CARYLLON DINING TABLE

Table with bent beech-wood structure and inlaid wooden top .

Tisch mit Struktur aus Buchenbugholz und Platte aus hölzernen Einlegearbeiten.

Tavolo con struttura in faggio curvato e piano in legno intarsiato.

Table avec structure en hêtre cintré et plateau en bois incrusté.

---

### FINISHES:

A. C01 (base) + bolivar (top)

B. D14 (base) + red caleidolegno (top)



---

TVCARDLGN  
Dimensions mm.  
H 760 | W 2200 | D 1100

## TABLES

### MAGISTRETTI O302

Table with bent beech-wood frame.  
Extra clear transparent glass top.

Tisch mit Gestell aus Buchenbugholz.  
Tischplatte aus transparentem,  
extra-klarem Glas.

Tavolo con struttura in faggio cur-  
vato. Piano in vetro trasparente  
extra chiaro.

Table avec structure en hêtre  
cintré. Plateau en verre transparent  
extra-clair.



FINISHES:  
BASE: B01, B03, B04, B08, Classic, Contemporary  
TOP: Extra Clear Glass

TVMAGILGV  
Dimensions mm.  
H 740 | W 1200 | D 1200

### REHBEINTISCH

Table with bent beech-wood  
frame and scratch-resistant beech-  
wood veneer top with solid wood  
border. Available in 3 sizes.

Tisch mit Gestell aus Buchenbugholz.  
Kratzfeste Tischplatte aus furnierter  
Buchenholz mit Einfassung aus  
Massivholz. In 3 Größen verfügbar.

Tavolo in faggio con struttura in  
legno curvato e piano impiallacciato  
in faggio verniciato antigraffio con  
bordatura in massello. Disponibile  
in 3 dimensioni.

Table en hêtre avec structure en  
bois cintré et plateau en bois plaqué  
inrayable avec bord en bois plein.  
Disponible en 3 dimensions.



FINISHES:  
B01, B03, B04, B08, Classic, Contemporary,

TVRH31LGN  
Dimensions mm.  
H 740 | W 700 | D 700

TVRH41LGN  
Dimensions mm.  
H 740 | W 900 | D 900

TVRH42LGN  
Dimensions mm.  
H 740 | W 1200 | D 1200

### RING DINING TABLE

Table with bent beech-wood frame  
and beech-wood veneer top.

Tisch mit Gestell aus Buchenbugholz  
und Tischplatte aus furnierter Buche.

Tavolo con struttura in faggio cur-  
vato e piano impiallacciato in faggio.

Table avec structure en hêtre cintré  
et plateau en hêtre plaqué.



FINISHES:  
B01, B03, B04, B08 Classic, Contemporary

TVRINDLGN  
Dimensions mm.  
H 750 | W 2100 | D 900

## TABLES

### SÄULE

Table available in 3 versions (ash, canaletto walnut and canaletto walnut with top covered in glossy laminate (SCOTCH BROWN / PLUM RED / DARK CHOCOLATE). Available in two lengths.

Tisch in 3 Versionen (Esche, Canaletto Walnuss und Canaletto Walnuss mit Platte aus glänzendem Laminat SCOTCH BROWN / PLUM RED / DARK CHOCOLATE). In zwei Längen erhältlich.

Tavolo disponibile in 3 versioni (frassino, in noce canaletto e nella versione noce canaletto con top rivestito in laminato lucido (SCOTCH BROWN / PLUM RED / DARK CHOCOLATE). Disponibile in due lunghezze.

Table disponible en 3 versions (frêne, noyer canaletto et noyer canaletto avec plateau en stratifié brillant (SCOTCH BROWN / PLUM RED / DARK CHOCOLATE). Disponible en deux longueurs.

#### FINISHES:

Base: B06, B07

Top: B06, B07, scotch brown / plum red / dark chocolate



ASH  
TVSA22FRA / TVSA30FRA  
Dimensions mm.  
H 750 | W 2200 / W 3000 | D 900



CANALETTO WALNUT  
TVSA22NCL / TVSA30NCL  
Dimensions mm.  
H 750 | W 2200 / W 3000 | D 900



CANALETTO WALNUT WITH GLOSSY TOP  
TVSA22LGN / TVSA30LGN  
Dimensions mm.  
H 750 | W 2200 / W 3000 | D 900

### BRANDY

Bar table available in two heights with metal round base and post, in polished copper or polished brass finishes. Round top in marble, laminate or natural/stained oak veneer, also available with edge ring in a finish to match the base.

Kaffeetisch in zwei verschiedenen Höhen mit runder Basis und Fuss aus Metall, Kupfer oder Messing poliert. Runde Tischplatte aus Marmor, Laminat oder furniert Eiche Natur/ gebeizt, auch verfügbar mit gleicher Umrandung wie Basis.

Tavolo da bar disponibile in due altezze con base rotonda stelo in metallo, nelle finiture rame lucido o ottone lucido. Top rotondo in marmo, laminato o impiallacciato rovere naturale o tinto, disponibile anche con ghiera perimetrale in finitura coordinata alla base.

Table de bar disponible en deux hauteurs avec base ronde et pied central en métal, pour les finitions en cuivre poli ou laiton poli. Plateau rond en marbre, recouvert de laminé ou plaqué chêne naturel ou teinté, également disponible avec un rebord périmétral en finition coordonnée à la base.



TABRANBAR  
Dimensions mm.  
H 1140 | W 700 | D 700  
with marble top  
H 1120 | W 700 | D 700



TBRRANBAR  
Dimensions mm.  
H 760 | W 700 | D 700  
with marble top  
H 740 | W 700 | D 700

## TABLES

### COGNAC

Bar table available in two heights with round metal base in bronze, copper or brass finishes. Post in stained or painted solid wood or in black epoxy powder painted metal. Round top in marble, laminate or natural/stained oak veneer, also available with edge ring in a finish to match the base.

Tavolo da bar disponibile in due altezze con base rotonda in metallo nelle finiture bronzo, rame, ottone. Stelo in massello di legno tinto, laccato o in metallo verniciato nero a polvere epossidica. Top rotondo in marmo, laminato o impiallacciato rovere naturale o tinto, disponibile anche con ghiera perimetrale in finitura coordinata alla base.

Kaffeetisch in zwei verschiedenen Höhen mit runder Metallbasis in Bronze, Kupfer oder Messing. Fuß aus gebeiztem oder lackiertem Massivholz oder aus Schwarz pulverbeschichtetem Metall. Runde Tischplatte aus Marmor, Laminat oder furniert Eiche Natur/gebeizt, auch verfügbar mit gleicher Umrandung wie Basis.

Table de bar disponible en deux hauteurs avec base ronde en métal pour les finitions en bronze, cuivre ou laiton. Pied central en bois massif teinté, laqué ou en métal peint en noir en poudre. Plateau rond en marbre, recouvert de laminé ou plaqué chêne naturel ou teinté, également disponible avec un rebord périmétral en finition coordonnée à la base.



TACOGNBAR  
Dimensions mm.  
H 1140 | W 700 | D 700  
with marble top  
H 1120 | W 700 | D 700



TBCOGNBAR  
Dimensions mm.  
H 760 | W 700 | D 700  
with marble top  
H 740 | W 700 | D 700

### GIN

Bar table with round post, top and base. Post in black epoxy powder painted metal. Round top in marble, laminate or natural/stained oak veneer, also available with edge ring in a finish to match the base.

Tavolo da bar con montante, piano e base rotondi. Montante in metallo verniciato a polvere epossidica nera. Piano rotondo in marmo, laminato o impiallacciato in rovere naturale o tinto, disponibile anche con ghiera perimetrale in finitura coordinata alla base.

Kaffeetisch mit rundem Pfeiler, Fuß und runder Tischplatte. Fuß aus Schwarz pulverbeschichtetem Metall. Runde Tischplatte aus Marmor, Laminat oder furniert Eiche Natur/gebeizt, auch verfügbar mit gleicher Umrandung wie Basis.

Table de bar avec pied central, plateau et base ronds. Pied central en métal peint en noir en poudre. Plateau rond en marbre, ou plaqué chêne naturel ou teinté, également disponible avec un rebord périmétral en finition coordonnée à la base.



TVGINNBAR  
Dimensions mm.  
H 760 | W 1000 | D 1000  
with marble top  
H 740 | W 1000 | D 1000

### PASTIS

Bar table with square post, top and base. In black painted metal or with bronze finish. Top covered in laminate or natural/stained oak veneer, also available with an edge ring with bronze finish.

Tavolo da bar con montante, piano e base quadrati. In metallo verniciato nero o con finitura bronzata. Top rivestito in laminato o impiallacciato rovere naturale o tinto, disponibile anche con ghiera perimetrale in finitura bronzata.

Kaffeetisch mit quadratischem Pfeiler, Fuß und quadratischer Tischplatte. Aus Schwarz lackiertem Metall oder in bronzefarbener Ausführung. Platte überzogen mit Laminat oder furniert Eiche Natur/gebeizt, auch verfügbar mit bronzefarbener Umrandung.

Table de bar avec pied central, base et plateau carrés. En métal peint en noir ou avec finition bronzée. Plateau recouvert de laminé ou plaqué chêne naturel ou teinté, également disponible avec un rebord périmétral en finition bronzée.



TVPASTBAR  
Dimensions mm.  
H 760 | W 700 | D 700

### PORTO

Bar table with round post, top and base. In black painted metal or with bronze finish. Top covered in laminate or natural/stained oak veneer, also available with an edge ring with bronze finish.

Tavolo da bar con montante, piano e base rotondi. In metallo verniciato nero o con finitura bronzata. Top rivestito in laminato o impiallacciato rovere naturale o tinto, disponibile anche con ghiera perimetrale in finitura bronzata.

Kaffeetisch mit rundem Pfeiler, Fuß und runder Tischplatte. Aus schwarz lackiertem Metall oder in bronzefarbener Ausführung. Platte überzogen mit Laminat oder furniert Eiche Natur/gebeizt, auch verfügbar mit bronzefarbener Umrandung.

Table de bar avec pied central, base et plateau ronds. En métal peint en noir ou avec finition bronzée. Plateau recouvert de laminé ou plaqué chêne naturel ou teinté, également disponible avec un rebord périmétral en finition bronzée.



TVPORTBAR  
Dimensions mm.  
H 760 | W 700 | D 700

## TABLES

### RUM

Bar table available in two heights with metal square base and post, in polished copper or polished brass finishes. Square top in marble, laminate or natural/stained oak veneer, also available with edge ring in a finish to match the base.

Tavolo da bar disponibile in due altezze con base quadrata e stelo in metallo, nelle finiture rame lucido o ottone lucido. Top quadrato in marmo, laminato o impiallacciato rovere naturale o tinto, disponibile anche con ghiera perimetrale in finitura coordinata alla base.

Kaffeetisch in zwei verschiedenen Höhen mit quadratischer Basis und Fuss aus Metall, Kupfer oder Messing poliert. Quadratische Tischplatte aus Marmor, Laminat oder furniert Eiche Natur/gebeizt, auch verfügbar mit gleicher Umrandung wie Basis.

Table de bar disponible en deux hauteurs avec base carrée et pied central en métal, pour les finitions en cuivre poli ou laiton poli. Plateau carré en marbre, recouvert de laminé ou plaqué chêne naturel ou teinté, également disponible avec un rebord périmétral en finition coordonnée à la base.



TARUMMBAR  
Dimensions mm.  
H 1140 | W 700 | D 700  
with marble top  
H 1120 | W 700 | D 700



TBRUMMBAR  
Dimensions mm.  
H 760 | W 700 | D 700  
with marble top  
H 740 | W 700 | D 700

### SHERRY

Bar table available in two heights with square metal base in bronze, copper or brass finishes. Post in stained or painted solid wood or in black epoxy powder painted metal. Square top in marble, laminate or natural/stained oak veneer, also available with edge ring in a finish to match the base.

Tavolo da bar disponibile in due altezze con base quadrata in metallo nelle finiture bronzo, rame, ottone. Stelo in massello di legno tinto, laccato o in metallo verniciato nero a polvere epossidica. Top quadrato in marmo, laminato o impiallacciato rovere naturale o tinto, disponibile anche con ghiera perimetrale in finitura coordinata alla base.

Kaffeetisch in zwei verschiedenen Höhen mit quadratischer Metallbasis in Bronze, Kupfer oder Messing. Fuß aus gebeiztem oder lackiertem Massivholz oder aus schwarz pulverbeschichtetem Metall. Quadratische Tischplatte aus Marmor, Laminat oder furniert Eiche Natur/gebeizt, auch verfügbar mit gleicher Umrandung wie Basis.

Table de bar disponible en deux hauteurs avec base carrée en métal pour les finitions en bronze, cuivre ou laiton. Pied central en bois massif teinté, laqué ou en métal peint en noir en poudre. Plateau carré en marbre, recouvert de laminé ou plaqué chêne naturel ou teinté, également disponible avec un rebord périmétral en finition coordonnée à la base.



TASHERBAR  
Dimensions mm.  
H 1140 | W 700 | D 700  
with marble top  
H 1120 | W 700 | D 700



TBSHERBAR  
Dimensions mm.  
H 760 | W 700 | D 700  
with marble top  
H 740 | W 700 | D 700

### VERMOUTH

Bar table in cast iron painted black. Round or square top covered in laminate or natural/stained oak veneer.

Tavolo da bar con struttura in fusione di ghisa verniciata nera. Top rotondo o quadrato rivestito in laminato o impiallacciato rovere naturale o tinto.

Kaffeetisch mit gusseiserner Struktur, schwarz lackiert.

Runde oder quadratische Tischplatte überzogen mit Laminat oder furniert Eiche Natur/gebeizt.

Table de bar avec structure en fusion de fonte peinte en noir. Plateau rond ou carré recouvert de laminé ou plaque chêne naturel ou teinté.



TVERMBAR  
Dimensions mm.  
H 760 | W 700 | D 700

## ARCH COFFEE TABLE

Bent beech-wood coffee table. Beech-wood veneer or "stopsol" glass top.

Kleiner Couchtisch aus Buchenbugholz. Tischplatte aus furnierter Buchenholz oder „Stopsol“- Glas.

Tavolino in faggio curvato. Piano disponibile in faggio impiallacciato o in vetro "stopsol".

Table basse en hêtre cintré. Plateau disponible en hêtre plaqué ou en verre "stopsol".



FINISHES:  
WOODEN TOP: B01, B03, B04, B08, Classic, Contemporary  
STOPSOL GLASS TOP: Classic

TVCOFFLGV  
Dimensions mm.  
H 460 | W 730 | D 730

TVCOFFLGN  
Dimensions mm.  
H 460 | W 730 | D 730

## DETOUR

Large coffee table with bent beech-wood frame and woven cane inserts. Open pore painted shelves in ash veneer. Brass feet.

Grosser Couchtisch mit Buchenbugholzgestell und eingesetztem Wiener Geflecht. Regale aus offenporigem, lackiertem Eschefurnier. Messing-Füßen.

Ampio tavolino con struttura in faggio curvato e inserti in paglia di Vienna. Ripiani in impiallacciato in frassino verniciato a poro aperto. Puntali in ottone.

Grande table basse avec structure en hêtre cintré et inserts en paille de Vienne. Étagères en plaqué frêne teinté à pores ouverts. Pieds en laiton.



FINISHES:  
B01, B07, C01

TVDETULGN  
Dimensions mm.  
H 400 | W 1200 | D 1140 | SHH 150

## DUET

Coffee table collection with structure in brass-plated steel and bent beech-wood with square sections. Top in black tinted glass or "Emperador Brown" marble. Available in three sizes.

Kleine Tischkollektion mit Messing plattiertem Stahl- und Buchenbugholzgestell mit quadratischem Querschnitt. Tischplatte aus rauch-schwarzem Glas oder "Emperador Brown" Marmor. Erhältlich in drei Größen .

Collezione di tavolini con struttura in acciaio ottonato e faggio curvato a sezione quadrata. Piano in vetro nero fumè o marmo "Emperador Brown". Disponibili in tre dimensioni.

Collection de tables basses avec structure en acier plaqué laiton et hêtre cintré à section carré. Plateau en verre noir fumé ou en marbre "Emperador Brown". Disponible en trois tailles.



FINISHES:  
BASE: C01  
TOP: Black Tinted Glass Or Marble

TVDUEALGV  
Dimensions mm.  
H 500 | W 450 | D 500

TVDUEBLGM  
Dimensions mm.  
H 350 | W 700 | D 550

TVDUECLGM  
Dimensions mm.  
H 300 | W 900 | D 700



## TABLES

### MOS SIDE TABLE

Side table with bent beech-wood frame and woven cane inserts. Open pore painted shelves in ash veneer. Brass feet.

Beistelltisch mit Buchenbugholzgestell und eingesetztem Wiener Geflecht. Regale aus offenporigem, lackiertem Eschefurnier. Messing-Füßen.

Tavolino con struttura in faggio curvato e inserti in paglia di Vienna. Ripiani impiallacciati in frassino verniciato a poro aperto. Puntali in ottone.

Table basse avec structure en hêtre cintré et inserts en paille de Vienne. Étagères en plaqué frêne teinté à pores ouverts. Pieds en laiton.



FINISHES:  
B01, B07, C01

TBMOSGLGP  
Dimensions mm.  
H 450 | W 500 | D 470 | SHH 150

### PEERS

Bent beech-wood coffee tables. Laminate top.

Kleine Beistelltische aus Buchenbugholz. Tischplatte aus Laminat.

Tavolini in faggio curvato. Piano in laminato.

Tables basses en hêtre cintré. Plateau laminé.



FINISHES:  
BASE A/B – C01  
PEER A (TVPEEALGN): HPL\_Blu notte 1861 / HPL\_Agave 1947  
PEER B (TVPEEBLGN): HPL\_Terra d'ombra 893 / HPL\_Tuareg 1942

TVPEEBLGN  
Dimensions mm.  
H 420 | W 740 | D 630

TVPEEALGN  
Dimensions mm.  
H 420 | W 930 | D 630

### SINGLE CURVE LOW TABLES

Coffee table collection with bent beech-wood frame and matt lacquered MDF top.

Kleine Tischkollektion mit Gestell aus Buchenbugholz und matt lackierten MDF-Platten.

Collezione di tavolini con struttura in faggio curvato e piano in MDF laccato opaco.

Collection de tables basses avec structure en hêtre cintré et plateau en MDF laqué mat.



FINISHES:  
BASE: B01, B03, B04, B06, Classic, Contemporary  
TOP: Classic, Contemporary

TVNLOCLGN  
Dimensions mm.  
H 300 | W 800 | D 800

TVNLOBLGN  
Dimensions mm.  
H 350 | W 600 | D 600

TVNLOALGN  
Dimensions mm.  
H 500 | W 450 | D 450

## WIENER BOX

Collection of low tables with brass-finished metal frames. Top and base in lacquered black mat wood. Woven cane side panels with solid beech frame. Available in two sizes.

Collezione di tavolini con struttura in metallo finitura ottone. Top e base in legno laccato nero opaco. Pannelli laterali in paglia di Vienna con cornice in massello di faggio. Disponibili in due dimensioni.

Kleine Tischkollektion mit einer Metallstruktur mit Messing Finish. Oberteil und Fuß aus mattschwarz lackiertem Buchenholz. Seitenteile aus Wiener Geflecht mit massivem Buchenholzrahmen. In zwei Größen erhältlich.

Collection de tables basses avec structure en métal finition laiton. Plateau et base en bois laqué noir mat. Panneaux latéraux en paille de Vienne avec cadre en hêtre massif. Disponible en deux dimensions.



FINISHES:  
C01

TVBOXALGN  
Dimensions mm.  
H 510 | W 570 | D 500

TVBOXBLGN  
Dimensions mm.  
H 330 | W 1070 | D 500

## ALLEGORY DESK

Desk with bent beech-wood frame and open pore painted ash-wood veneer top. Also available with drawer. Woven cane circular decorative element.

Scrivania con struttura in faggio curvato e piano impiallacciato in frassino verniciato a poro aperto, disponibile anche con cassetto. Elemento decorativo circolare in paglia di Vienna.

Schreibtisch mit Gestell aus Buchenbugholz, Tischplatte aus of-fenporig lackierter furnierter Esche und rundem Dekoelement aus Wiener Geflecht. Auch verfügbare mit Schublade.

Bureau avec structure en hêtre cintré et plateau en plaqué frêne teinté à pores ouverts. Disponible aussi avec tiroir. Élément décoratif circulaire en paille de Vienne.



FINISHES:  
ASH-WOOD TOP: B07, Classic  
BEECH WOOD FRAME: B01, Classic

DKALECPGL  
Dimensions mm.  
H 1260 | W 1000 | D 660 | TH 750

DKALEGPGL  
Dimensions mm.  
H 1260 | W 1000 | D 660 | TH 750

## ARCADIA

Pouf with bent beech-wood frame, generous upholstered seat cushion.

Pouf mit Gestell aus Buchenbugholz, großer Sitzpolster.

Pouf con struttura in faggio curvato, ampio cuscino di seduta imbottito.

Pouf avec structure en hêtre cintré, grand coussin rembourré pour l'assise.



FINISHES:  
B01, B03, B04, B08, Classic, Contemporary

POARCATES  
Dimensions mm.  
H 450 | W 1100 | D 1100 | SH 450

## ARCH CLOTHES VALET

Two-tone bent beech-wood clothes valet: black and natural beech.

Stummer Diener aus zweifarbigem Buchenbugholz: in Schwarz und Buche Natur.

Servo muto in faggio curvato bicolore: nero e faggio naturale.

Valet en hêtre cintré bicolore: noir et hêtre naturel.



FINISHES:  
B01-C01 / C01-B01

CHVALELGN  
Dimensions mm.  
H 1070 | W 460 | D 260

## CLOUD

Bent beech-wood umbrella stand, available in lacquered with natural beech feet. Transparent neutral receptacle.

Schirmständer aus Buchenbugholz. Lackiert mit Füße in Buche Natur verfügbar. Schale neutral-durchsichtig.

Portaombrelli in faggio curvato; disponibile laccato con gambaleto in faggio naturale. Vaschetta colore neutro trasparente.

Porte-parapluies en hêtre cintré; disponible en laqué avec les pieds en hêtre naturel. Réceptif couleur neutre transparent.



FINISHES:  
Classic and Natural Legs

OMCLOULGN  
Dimensions mm.  
H 740 | W 406 | D 406

## EYESHINE MIRRORS

Bent ash-wood mirrors available in three versions. Each version is available in two sizes.

Specchi in frassino curvato disponibili in tre versioni. Ogni versione è disponibile in due dimensioni.

Spiegel aus Eschenbugholz in drei Versionen erhältlich. Jede Version ist in zwei Größen erhältlich.

Miroirs en frêne cintré disponibles en trois versions. Chaque version est disponible en deux dimensions.



FINISHES:  
B07, Classic, D03

SHEYESCC1  
Dimensions mm.  
H 640 | W 640 | D 40

SHEYESCO1  
Dimensions mm.  
H 640 | W 640 | D 40

SHEYESOC1  
Dimensions mm.  
H 560 | W 730 | D 40

SHEYESCC2  
Dimensions mm.  
H 320 | W 320 | D 20

SHEYESCO2  
Dimensions mm.  
H 320 | W 320 | D 20

SHEYESOC2  
Dimensions mm.  
H 280 | W 360 | D 20

## FENG

Modular folding screen with bent beech-wood frame and fabric partition panels stretched over metal frame. Brass details. Available in selected fabrics with 2 or 3 panels.

Paravent mit gebogenem Buchenholzrahmen und Trennwänden aus gespanntem Gewebe auf Metallrahmen. Details aus Messing. Erhältlich in ausgewählten Stoffe mit 2 oder 3 Stoffbahnen.

Paravento con struttura in faggio curvato e pannelli divisorii in tessuto teso su struttura di metallo. Dettagli in ottone. Disponibile in tessuti selezionati con 2 o 3 pannelli.

Paravent modulaire avec structure en hêtre cintré et panneaux diviseurs en tissu tendu sur cadre métallique. Détails en laiton. Disponible en tissus sélectionnés avec 2 ou 3 panneaux.

FINISHES:  
B01, C01

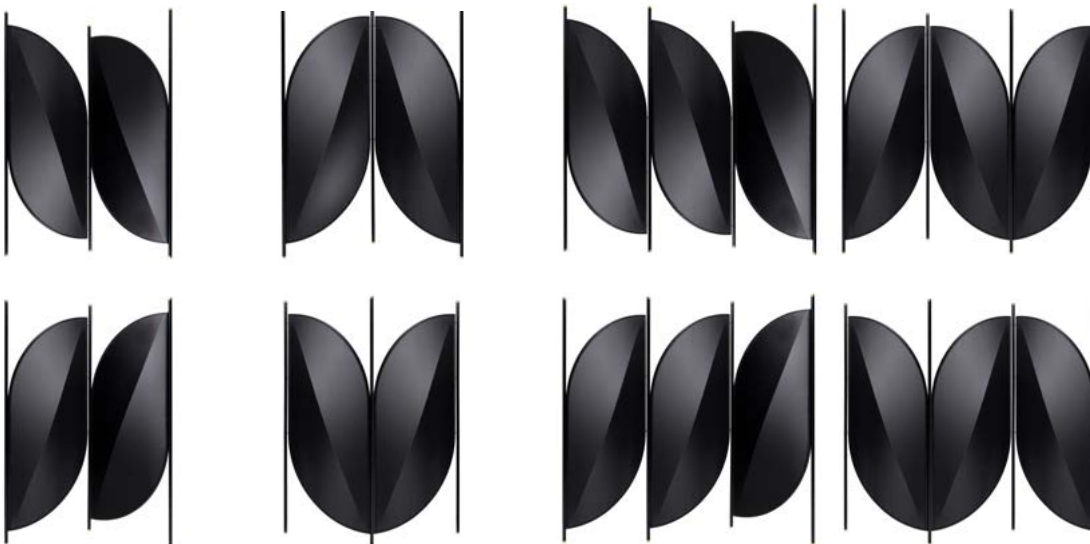

PRFEN2TES/1  
Dimensions mm.  
H 1940 | W 1400 | D 200

PRFEN2TES/2  
Dimensions mm.  
H 1940 | W 1400 | D 200

PRFEN3TES/1  
Dimensions mm.  
H 1940 | W 2320 | D 200

PRFEN3TES/2  
Dimensions mm.  
H 1940 | W 2320 | D 200

## FURIA

Rocking horse with bent beech-wood frame. Seat and details available in leather only.

Cavallino a dondolo con struttura in faggio curvato. Seduta e dettagli disponibili solo in pelle.

Schaukelpferd mit Gestell aus Buchenbugholz. Sitz und Details nur aus Leder.

Petit cheval à bascule avec structure en hêtre cintré. Assise et détails disponibles uniquement en cuir souple.



FINISHES:  
C01

CAFURITES  
Dimensions mm.  
H 690 | W 520 | D 710 | SH 450

## KLEIDERSTÄNDER P. 29

Bent beech-wood coat stand.

Appendiabiti in faggio curvato.

Kleiderständer aus Buchenbugholz.

Porte-manteaux en hêtre cintré.



FINISHES:  
B01, B03, B04, B08, Classic, Contemporary

APKL19LGN  
Dimensions mm.  
H 1820 | W 620 | D 620

## KLEIDERSTÄNDER

Bent beech-wood coat stand.

Appendiabiti in faggio curvato.

Kleiderständer aus Buchenbugholz.

Porte-manteaux en hêtre cintré.



FINISHES:  
B01, B03, B04, B08, Classic, Contemporary

AP2204LGN  
Dimensions mm.  
H 1850 | W 520 | D 520

## KOLO MOSER

Bent beech-wood coat stand.

Appendiabiti in faggio curvato.

Kleiderständer aus Buchenbugholz.

Porte-manteaux en hêtre cintré.



FINISHES:  
Classic

APKOLQGN  
Dimensions mm.  
H 1950 | W 700 | D 700

## LADDER

Bent ash-wood decorative element, useful as a clothes valet. Available in 3 sizes.

Elemento decorativo in frassino curvato, con funzione di servomuto. Disponibile in 3 dimensioni.

Dekoratives Element aus Eschenbugholz, ideal als Stummer Diener. In 3 Größen verfügbar.

Élément décoratif en frêne cintré avec fonction de valet. Disponible en 3 dimensions.



FINISHES:  
B07, Classic

CML250LGN  
Dimensions mm.  
H 2570 | W 450 | D 36

CML200LGN  
Dimensions mm.  
H 2055 | W 450 | D 36

CML160LGN  
Dimensions mm.  
H 1540 | W 450 | D 36

## MAJORDOMO

Square-section beech-wood clothes valet with woven cane seat and shelf.

Servo muto in faggio a sezione quadrata con seduta e piano d'appoggio in paglia di Vienna.

Stummer Diener aus Buche mit quadratischem Querschnitt mit Sitzfläche und Abdeckplatte aus Wiener Geflecht.

Valet en hêtre à section carrée avec assise et plan d'appui en paille de Vienne.



FINISHES:  
B01, Classic

CAMAJOPGL  
Dimensions mm.  
H 900 | W 610 | D 610 | SH 450 | AH 680

## STOCKSESSEL

A folding seat and walking cane combined. Woven cane seat.

Sgabello pieghevole e bastone da passeggio combinato. Sedile in paglia di Vienna.

Spazierstock und Klapphocker in einem. Sitz aus Wiener Geflecht.

Tabouret pliant et canne combinée. Assise en paille de Vienne.



FINISHES:  
B01, B03, B04, B08, Classic, Contemporary

BSSTOKLGN  
Dimensions mm.  
H 640 | W 230 | D 440 | SH 540

## WALTZ

Modular wall-mounted bent ash-wood coat rack with one brass hook included. Additional hooks are sold separately.

Appendiabiti modulare da parete in frassino curvato con un gancio in ottone incluso. Ganci supplementari venduti separatamente.

Modular aufgebaute Wandgarderobe aus Eschenbugholz, mit einem Messinghaken enthalten. Zusätzliche Haken sind separat erhältlich.

Porte-manteaux modulable mural en frêne cintré avec un crochet en laiton inclus. Crochets supplémentaires vendus séparément.



---

FINISHES:  
B07, Classic

CHWALZLGN  
Dimensions mm.  
H 540 | W 930 | D 70

## TIPI

Linén pendant lamp available in 3 colours: eggshell white, caramel and cerulean blue.

Warm white poplin inner lining and ecru rope trims.

Entirely hand-sewn, painted metal frame, covered in rope. Electric cable covered in caramel-coloured fabric, white parchment diffuser. Available in 2 sizes.

Lampada a sospensione in lino disponibile in 3 colori: bianco guscio d'uovo, caramello e blu ceruleo.

Fodera interna in popeline bianco caldo e rifiniture in corda ecru.

Interamente cucito a mano, telaio in metallo verniciato, rivestito in corda. Cavo elettrico rivestito in tessuto color caramello, diffusore in pergamena bianca. Disponibile in 2 misure.

Leinen-Pendelleuchte in 3 Farben erhältlich: Cremeweiß, Karamell und Ceruleanblau. Innenfutter aus warmweißer Popeline und ecru-farbener Seilbesatz. Vollständig von Hand genäht, lackierter Metallrahmen, mit Seil bezogen. Stromkabel mit karamellfarbenem Stoff überzogen, Diffusor aus weißem Pergament. In zwei Größen erhältlich.

Lampe à suspension en lin disponible en 3 couleurs : blanc coquille d'œuf, caramel et bleu azur. Doublure intérieure en popeline blanc chaud et finitions en corde écru. Entièrement cousu à la main, cadre en métal verni, recouvert de corde. Câble électrique recouvert de tissu couleur caramel, diffuseur en parchemin blanc. Disponible en 2 dimensions.



LST120TES  
with 3 E27 lamp holders  
Dimensions mm.  
H 900 | W 1200 | D 1200

LST070TES  
with 1 E27 lamp holders  
Dimensions mm.  
H 540 | W 700 | D 700

## WAGASA

Suspended and floor lamp with Carrara marble base and pole in black lacquered beech wood. Fabric lampshade with woven cane trim. Parchment light diffuser in the suspended version.

Lampada a sospensione e da terra con basamento in marmo Carrara e stelo in legno di faggio laccato nero. Paralume in tessuto con inserti in paglia di Vienna. Diffusore di luce in pergamena solo nella versione a sospensione.

Pendelleuchte und Stehlampe mit Sockel aus Carrara-Marmor und Stiele aus schwarz lackierter Buche. Lampenschirm aus Gewebe mit Umrandung aus Wiener Geflecht. Pergament-Lichtdiffusor nur in der Pendelversion.

Lampe à suspension et de plancher avec la base en marbre de Carrare et le tige en bois de hêtre laqué noir. Abat-jour en tissu avec bordure en paille de Vienne. Diffuseur de lumière en parchemin uniquement dans la version à suspension.



FINISHES:  
POLE: C01  
LAMP SHADE: Kvadrat Reflex 449 / Kvadrat Fuse 631 / Kvadrat Fuse 351  
Kvadrat Fuse 981 / Kvadrat Reflex 159

LPWAGATES  
Dimensions mm.  
H 1720 | W 650 | D 650

LSWAGATES  
Dimensions mm.  
H 500 | W 650 | D 650



---

## AROUND COLORS RUGS COLLECTION

Hand-tufted rugs in wool and viscose. Available in 4 shapes and colors.

Handgefertigte Teppiche aus Wolle und Viskose. Erhältlich in 4 Formen und Farben.

Tappeti taftati a mano in lana e viscosa. Disponibili in 4 forme e colori.

Tapis tuftés à la main en laine et viscose. Disponible en 4 formes et couleurs.

---



YELLOW  
TPACOLTA1  
Dimensions mm.  
W 3000 | D 1900



PINK  
TPACOLTA2  
Dimensions mm.  
W 3000 | D 2300

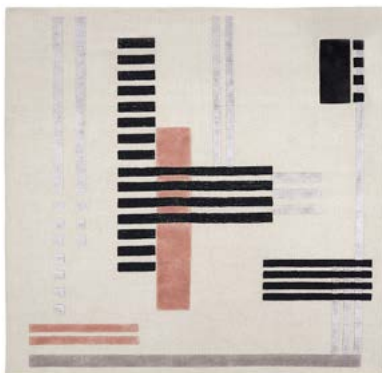

GREY  
TPACOLTA3  
Dimensions mm.  
W 2500 | D 2500



BROWN  
TPACOLTA4  
Dimensions mm.  
W 2600 | D 1600

---



X. 10/30  
CENA 8 P.  
M. SMITH



4

**Ample**

p. 40, 41, 42, 236, 293 Kvadrat Vanir 443  
p. 43, 44, 45 Kvadrat Sisu 805

**Arcadia**

p. 270 Kvadrat Sonar 3 col. 773  
p. 271 Kvadrat Sisu col. 525

**Beaulieu**

p. 49, 239 Kvadrat Remix 3 col. 912  
p. 46, 47 Kvadrat Raas col. 942  
p. 46, 47 Kvadrat Fuse col. 981  
p. 232, 233 Dedar Karandash col. 005  
p. 235, 238 Kvadrat Remix 3 col. 536

**Bistrotstuhl**

p. 50 Kvadrat Divina 3 col. 956  
Kvadrat Divina 3 col. 876  
Kvadrat Divina 3 col. 936  
p. 51 Kvadrat Fuse col. 351

**Bodystuhl**

p. 54, 299 Kvadrat Fuse 121  
p. 55 Dedar Adamo ed Eva col. 109 anice

**Brezel**

p. 56 Discontinued fabric  
p. 57 Discontinued fabric

**Caféstuhl**

p. 59 Kvadrat Fuse col. 981

**Coat Rack Bench**

p. 122 Kvadrat Coda 2 col. 116

**Chignon**

p. 134, 135 Kvadrat Steelcut Trio 3 col. 124

**Czech**

p. 64, 65 Loro Piana Zelander Check col. 205

**Hagu**

p. 70, 72, 292 Kvadrat Zero 001  
p. 73 Kvadrat Vidar 956

**Feng**

p. 274 Kvadrat Campas 300 col. 554  
p. 276 Kvadrat Campas 300 col. 104

**Hideout Collection**

p. 136, 137 Discontinued fabric  
p. 138, 139 Kvadrat Vidar 106  
p. 140 Kvadrat Twill Weave col. 990  
p. 141 Dedar Nimbus 007 Nuvola

**Jannis Collection**

p. 144, 145, 201 Kvadrat Steelcut Trio 3 col. 153  
p. 142, 143 Kvadrat Helia 253

**Lehnstuhl**

p. 146 Steyr B08 005  
p. 148 Kvadrat Divina 3 col. 742

**Loie**

p. 151 Kvadrat Twill Weave col. 570  
p. 152 Loro Piana Altai Unito col. 39 Zenzero  
p. 143, 153 Kvadrat Vanir 443

**Loop Dining**

p. 154, 156 Kvadrat Vidar 106

p. 155, 157 Kvadrat Vidar 872

**Loop Lounge**

p. 158, 159 Kvadrat Vidar 4 col. 653  
p. 158 Kvadrat Vidar 4 col. 106  
p. 159, Kvadrat Vidar 4 col. 443  
p. 159, Kvadrat Vidar 4 col. 956  
p. 160 Kvadrat Vidar 4 col. 956 / 656

**Loop Banquette**

p. 158, 159 Kvadrat Vidar 4 col. 182  
p. 161 Kvadrat Vidar 4 col. 956 / 656

**Luftballon Lounge**

p. 162, 256 Kvadrat Coda 2 col. 962  
p. 163 Kvadrat Sonar 3 col. 974  
p. 163, 164, 275, 294 Kvadrat Coda 2 col. 103

**Luftballon Sofa**

p. 162, 165 Kvadrat Coda 2 col. 962  
p. 166, 167 Kvadrat Safire col. 007

**Loos Café Museum**

p. 75 Discontinued fabric

**Magistretti 0301**

p. 76 Cuoio/Leather C01 002

**Malit**

p. 78, 221 Kvadrat Divina MD col. 213  
p. 79, 247 Discontinued fabric

**Mickey**

p. 168 Kvadrat Vidar 472 / Kvadrat Vidar 106  
p. 169 Kvadrat Vidar 965 / Kvadrat Vidar 943

**Mos Bench**

p. 199, 214 Discontinued fabric  
p. 198, 139 Dedar Sunday col. Ocean  
p. 171 Loro Piana Connemara col. 14 Cowes

**Morris**

p. 80 Discontinued fabric  
p. 81 Kvadrat Divina 3 col. 154  
p. 229 Kvadrat Hallingdal 65 col. 723

**N.0**

p. 82 Steyr B08 015  
p. 83 Hallein A06 007  
p. 84 Steyr B08 005

**N.14**

p. 88 Kvadrat Sisu 405

**N.18**

p. 90 Discontinued fabric  
p. 243 Discontinued fabric  
p. 243 Discontinued fabric  
p. 243 Discontinued fabric

**N.200**

p. 171, 172 Loro Piana Connemara col. 14 Cowes

**N.811**

p. 92 Kvadrat Ecriture 970  
p. 95, 248 Eisenstadt A05 002

**N.811 Barstool and counter**

p. 94 Eisenstadt A05 010  
p. 94 Eisenstadt A05 002

p. 96, 97, 296 Kvadrat Savanna col. 122

**Pince**

p. 98, 99 Kvadrat Hallingdal 65 col. 166

**Post Mundus**

p. 100 Kvadrat Harald 3, col. 192  
p. 101 Discontinued fabric

**Postsparkasse**

p. 102, 103 Kvadrat Sisu 805

**Promenade Sofa**

p. 174, 175, 176, 258 Steyr B08 016

**Promenade Lounge**

p. 177 Dedar Adamo ed Eva Anice 109

**Rue**

p. 214, 216 Loro Piana Connemara col. 10 Malachite

**Sölden**

p. 106, 107 Kvadrat Merit col. 007  
p. 108, 109, 246 Steyr B08 018

**Sugiloo**

p. 110 Kvadrat Ecriture 210  
p. 111 Kvadrat Rass 142  
p. 224, 244 Discontinued fabric

**Suzenne Lounge**

p. 180, 181 Discontinued fabric  
p. 182 Kvadrat Coda 2 col. 232

**Suzenne Sofa**

p. 180, 181 Discontinued fabric  
p. 183 Discontinued fabric

**Targa Lounge**

p. 185 Kvadrat Ecriture 200  
p. 186 Kvadrat Divina 3 col. 856  
p. 187 Steyr B08 004

**Targa Sofa**

p. 185 Kvadrat Ecriture 200  
p. 170 Kvadrat Remix 3 col. 123  
p. 186 Kvadrat Divina 3 col. 856  
p. 266 Kvadrat Raas col. 182

**Targa Modular**

p. 188, 189 Kvadrat Steelcut Trio 3 col. 124

**Trio**

p. 131 Steyr B08 005

**Vienna 144 Barhocker and Hocker**

p. 132 Discontinued fabric  
p. 133, 238 Kvadrat Remix 3 col. 912  
p. 133, Kvadrat Remix 3 col. 516

**Wiener stuhl**

p. 118 Kvadrat Coda 2 col. 100  
p. 119, 234 Discontinued fabric  
p. 220 Discontinued fabric

**Yvette**

p. 218, 219 Discontinued fabric

### Art Direction:

Gebrüder Thonet Vienna GmbH (2023)  
R+W (2014-2022)

### Graphic Project:

Graphicstudio | Gianfranco Martorella

### Photo:

Thomas Pagani (2023)  
Gionata Xerra Studio (2014-2022)  
Neferstudio (pag. 190, 297)  
Margherita Bonetti (pag. 292)

### Concept e styling:

Paola Pastorini Studio (2023)  
Simona Silenzi Studio (2014-2022)

### Styling Assistant:

Massimiliano Colombo (2023)  
Gaia Marchesini, Giordano Sarno (2018-2022)

### Photo Assistant:

Simona Verde, Diletta Simonetti, Simone Bruzzi (2023)  
Leonardo Duggento, Marco Manigrasso (2014-2022)

### Post produzione immagini:

Thomas Pagani Studio (2023)  
Pierpaolo Mazzola (2014-2022)

### Photo credits of designer portraits:

Anki Gneib photo by Kristian Pohl  
Chiara Andreotti photo by Filippo Bamberghi  
Cristian Mohaded photo by Manuel Mazzaro  
Dainelli Studio photo by Carolina GheriEd NG photo by Kohei Take  
Front photo by Lena Modigh  
Storagemilano photo by Helenio Barbetta  
Paola Pastorini photo by Franco Chimenti  
Charlie Styrbjörn photo by Jonas Lindsest  
Gordon Guillaumier photo by Andrea Basile  
India Mahdavi photo by Paolo Roversi  
Luca Nichetto photo by Morgan Norman  
Michael Anastassiades photo by Ben Murphy  
Michele De Lucchi photo by Giovanni Gastel  
Nigel Coates photo by Kensington Leverne  
Serena Confalonieri photo by Bucci Studio  
Philip Nigro photo by Delfino Sisto Legnani  
Testatonda photo by Ivan Cazzola

### Thanks to:

Porto Urbano  
Giardino Segreto - Arch. Cristiana Ruspa  
Le Roy Music Hall di Toni Campa e Luciana De Biase  
Alice in Wonderland - Studio Marcante Testa (UdA)  
Bottega Baretto - www.bottegabaretti.com  
Caffè Mulassano  
Casa Fulvia Moscheni - Fabio Fantolino Architetto  
Casa Sette - Fabio Fantolino Architetto  
Copernico Torino www.coperni.co  
Dash Kitchen (To)  
Dopolavoro Bicocca Milano  
Duparc Contemporary Suites  
Grattacielo Intesa Sanpaolo  
Il Deposito Bistrot  
Lo Stornato www.stornato.it  
NH Collection Piazza Carlna  
Notaio Giuseppe Volpe & Associati - Studio Marcante Testa (UdA)  
Ristorante Il Bastimento

### PALAZZO MADAMA

Museo Civico d'arte antica, Torino.  
on kind concession from  
Fondazione Torino Musei.  
It is forbidden to further reproduce  
or duplicate by any means.

### PALAZZO REALE

Thanks to Palazzo Reale and  
Caffetteria Reale Di Torino,  
on kind concession  
from Ministero dei Beni e delle  
Attività Culturali e del Turismo,  
Direzione Regionale per i Beni  
culturali e paesaggistici  
del Piemonte.

### Props:

Ursula Futura  
Laura Pasquino  
Enrico Donadello  
La Mano studio  
Milena Kling  
Pierre Malin  
Nassilamps

Agape Applicata Astep Am Living Studio Amini Another Country Artemide AYTM  
Bitossi Home Bloc Studios Bosa Trade Brionvega Budri Italian Marble Inlay - Ad  
Group Fragile Milano Carpet Edition CC Tapis Danese Davide Aquini Flos Fondaco  
FontanaArte FPM Milano Francesca Verardo Ceramics Galleria Nicola Quadri  
Golran Galleria Salvatore Lateri Il Coccio design edition Ilaria Innocenti Interno  
Italiano Kanz Architetto Knindustrie Presso Agape12 - Milano Kristina Dam Kundalini  
Lindell&Co Littala Louise Poulsen Luceplan Marzi ceramiche Martina Geroni Meyers  
& Fügmann MM Lampadari Mmairi Nahoor Limelight Nemo Cassina Nilufar  
Gallery Nodus Nude Glass Nuoveforme Oeufice Design Studio Oluce Once Milano  
Palorosa Paola C Pulpo Pasabahce (Garbo) Penta Light Raawii Sambonet Santa  
& Cole Scandola Marmi Schola Testori Society Stilnovo Stip Stories of Italy Tine K  
Home Vanessa Mitrani Zanellato Bortotto.

The Manufacturer reserves the right to modify products and accessories at any time without prior notice.

Die Firma behält sich vor, Produkte und Zubehör unabhängig vom Zeitpunkt und ohne jede Voranmeldung zu ändern.

L'azienda si riserva il diritto in qualunque momento di apportare senza preavviso modifiche a prodotti e accessori.

L'entreprise se réserve de modifier les articles et les accessoires en chaque moment et sans préavis.

L'azienda si dichiara disponibile a riconoscere eventuali diritti per il materiale iconografico di cui non sia stato possibile individuare la fonte.

The manufacturer declares to be available to recognize possible rights for iconographic material, whose origin was not possible to be traced back.

**Gebrüder Thonet Vienna GmbH**  
Prinz Eugen Straße 42 - 1040 Wien, (AT)  
[www.gebruederthonetvienna.com](http://www.gebruederthonetvienna.com)

Offices of the trademarks' licensee  
Production Furniture International S.p.A.  
Via Foggia, 23/H - 10152 Torino (TO) Italy  
Phone: 0039 011 0133330  
[info@gebruederthonetvienna.com](mailto:info@gebruederthonetvienna.com)

Print: AGT s.r.l. (TO) 07/2023

When printing on paper, the shades of the colours of various materials cannot be faithfully reproduced. Therefore it must only be considered indicative and cannot constitute a reason for dispute or for the return of the product.

Bei Papierdruck können die Farbtöne der verschiedenen Materialien nicht originalgetreu wiedergegeben werden. Bei den Abbildungen sind daher Abweichungen möglich, die kein Recht auf Beanstandungen oder Rückgabe des Produkts begründen.

Nella stampa su carta, la tonalità dei colori dei vari materiali non può essere riprodotta fedelmente. Pertanto deve considerarsi indicativa e non potrà costituire motivo di contestazione o di resa del prodotto.

Lors de l'impression sur papier, la tonalité des couleurs des différents matériaux ne peut pas être parfaitement reproduite. Les couleurs ne sont donc qu'indicatives et ne pourront pas constituer un motif de contestation ou de retour du produit.

Printed on Fedrigoni Symbol Matt Plus Premium White.



GEBRÜDER  
THONET  
VIENNA

WIENER  
•GIV•  
DESIGN

NEW COLLECTION 2024



# MON-ÎLE

DESIGN BY SERGIO BICEGO

Family of upholstered furniture consisting of a modular sofa and a roundshaped lounge chair. The seat is upholstered and the backrest is available upholstered or in woven cane with a solid ash wood frame. **The sofa is available in multiple combinations.** The collection is completed by two ash coffee tables with woven cane inserts.

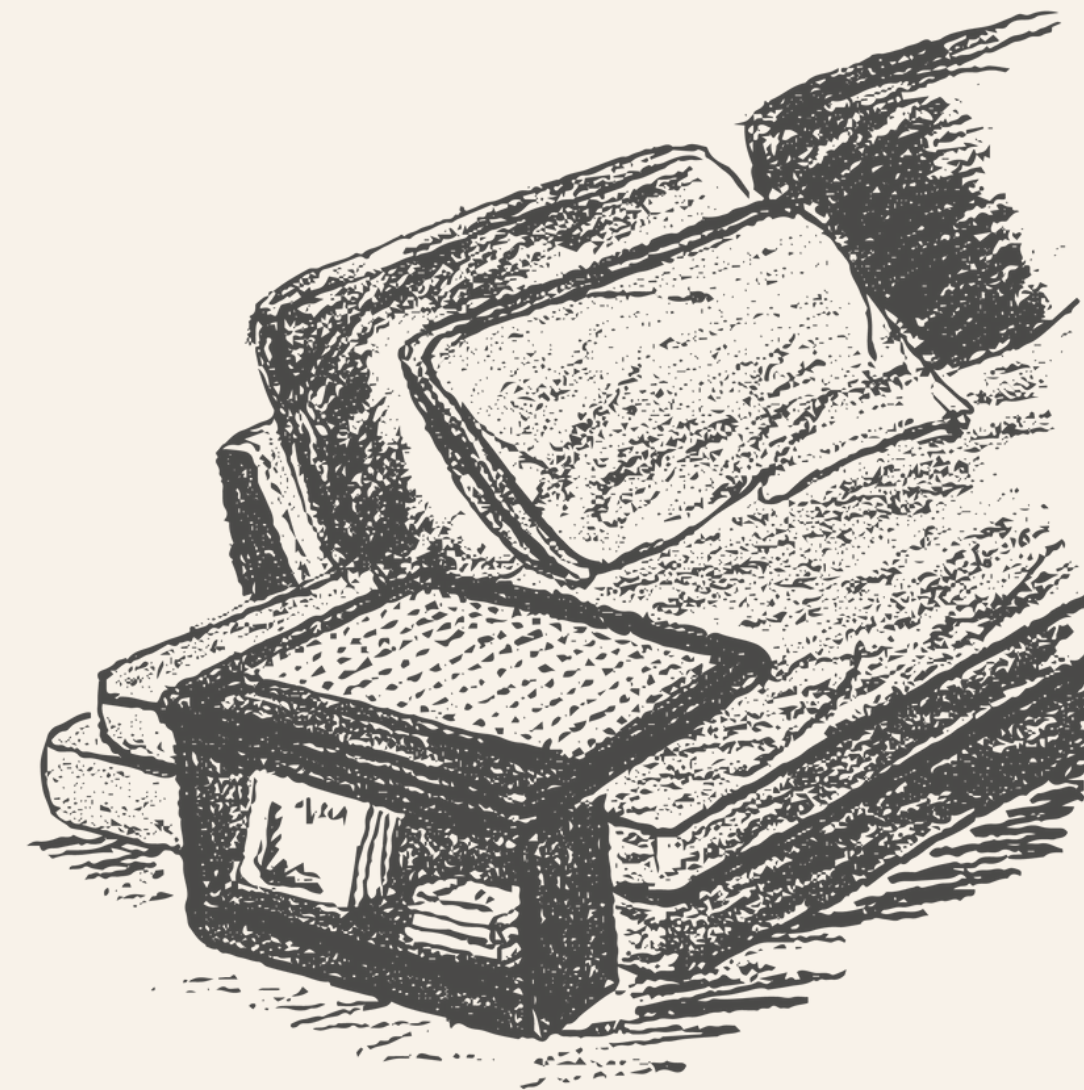
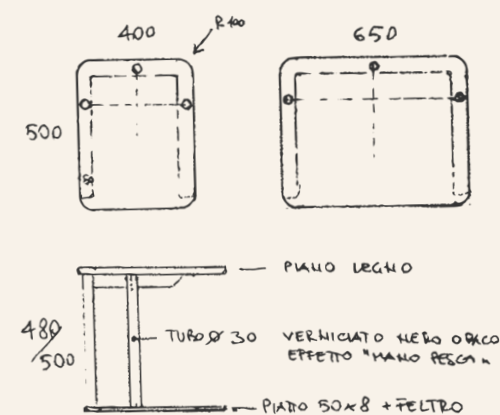













SCENE N.1

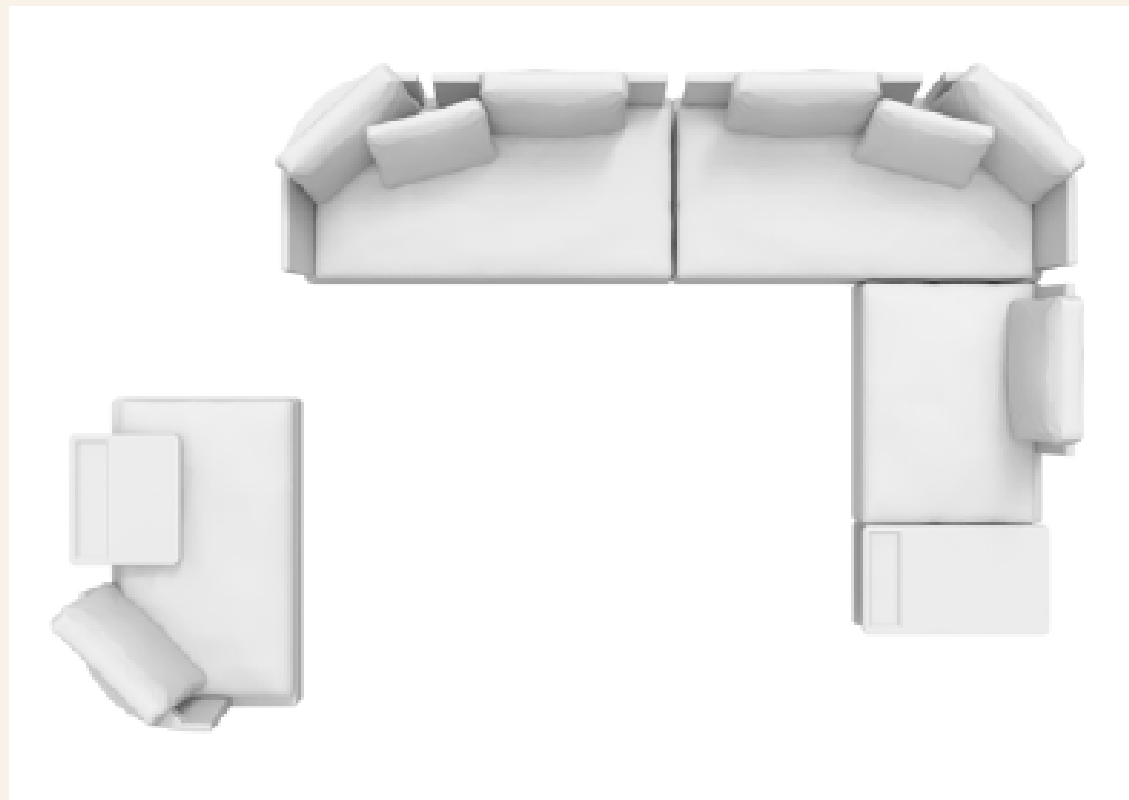

Price list pag. 113

SCENE N.2

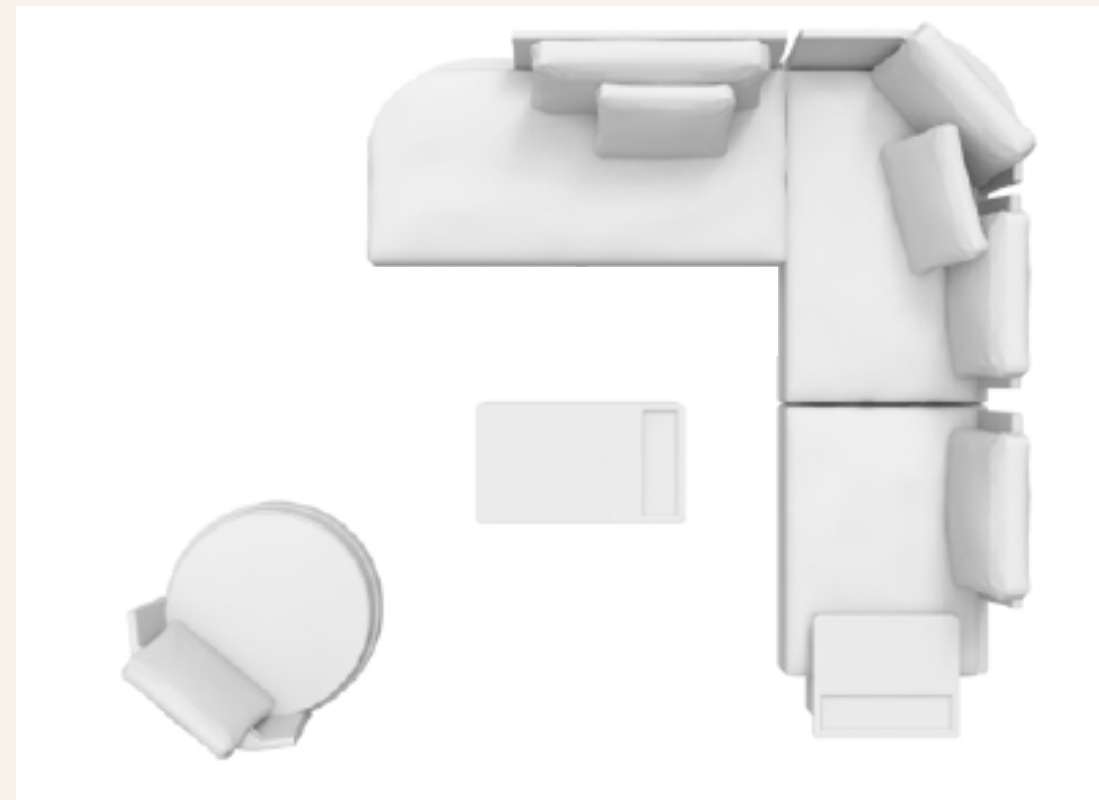

Price list pag. 112

SCENE N.3

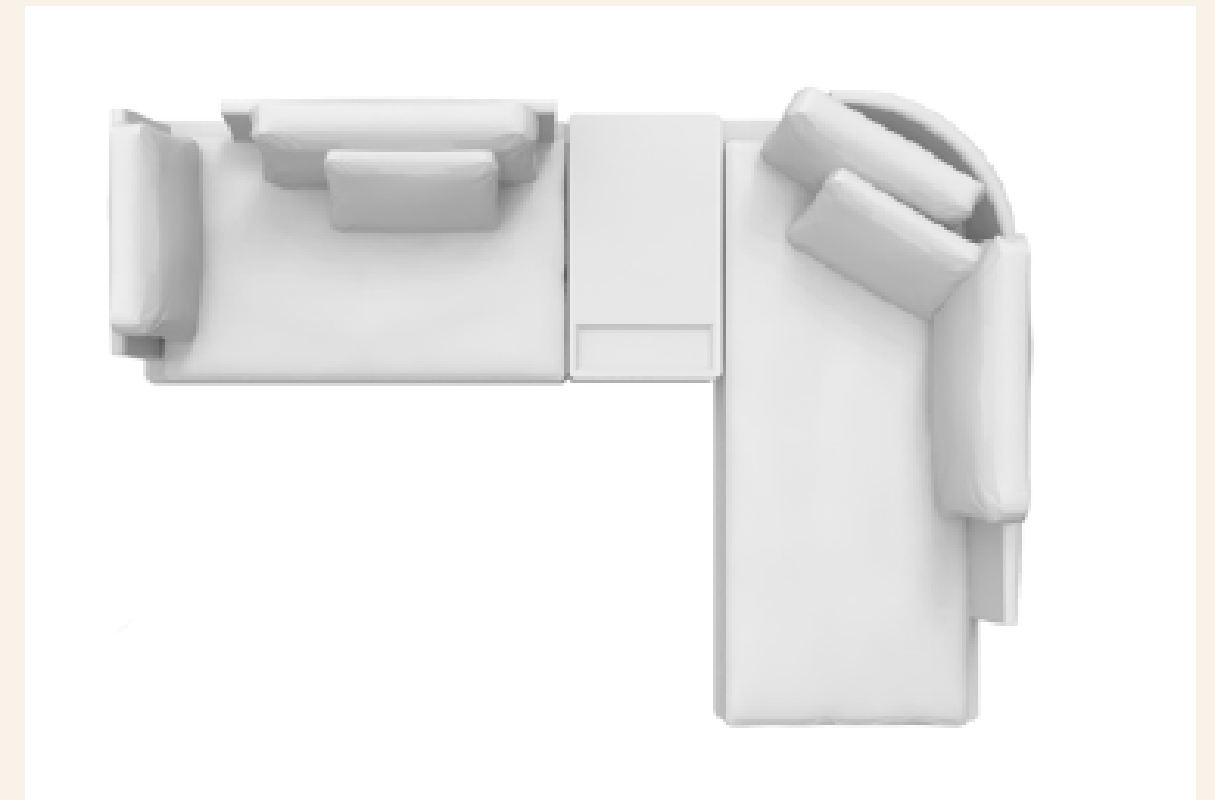

Price list pag. 111



# YOU

DESIGN BY LUCIDIPEVERE

YOU is the **new stackable chair** designed by LucidiPevere. The **elegant arc of curved solid wood** serves both as a visual element, enhancing its side profile, and as a functional feature, ensuring stability and practicality during stacking, thanks to the protective rubber pads attached to the ends. The **beechwood frame** supports a shell that can be left natural or colored, with the option of upholstery in matching or contrasting hues.







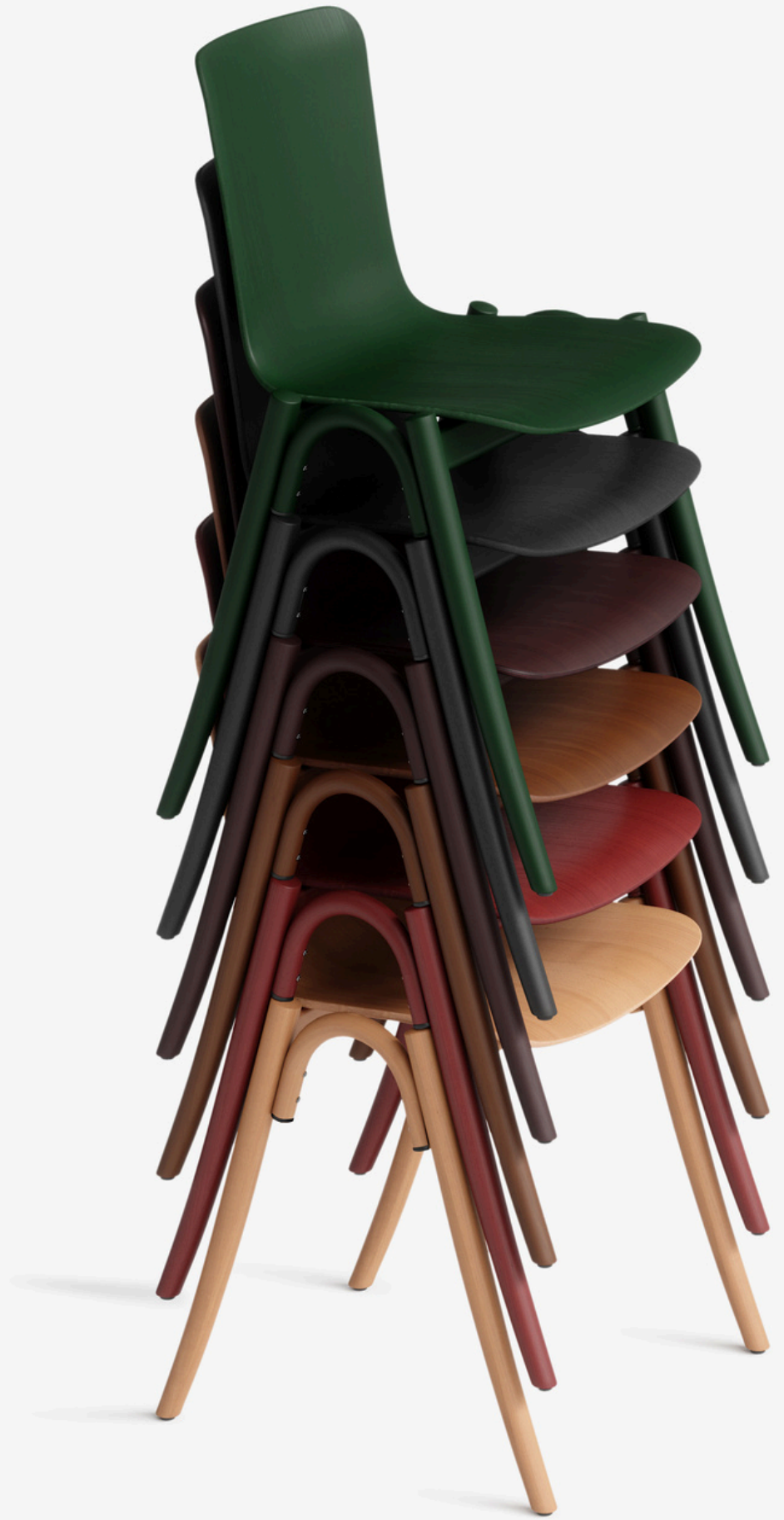

A **bistro chair** entirely made of wood, accessorizable with a **soft pad**.



# TECHNICAL DATA SHEET

YOU CHAIR | LUCIDIPEVERE

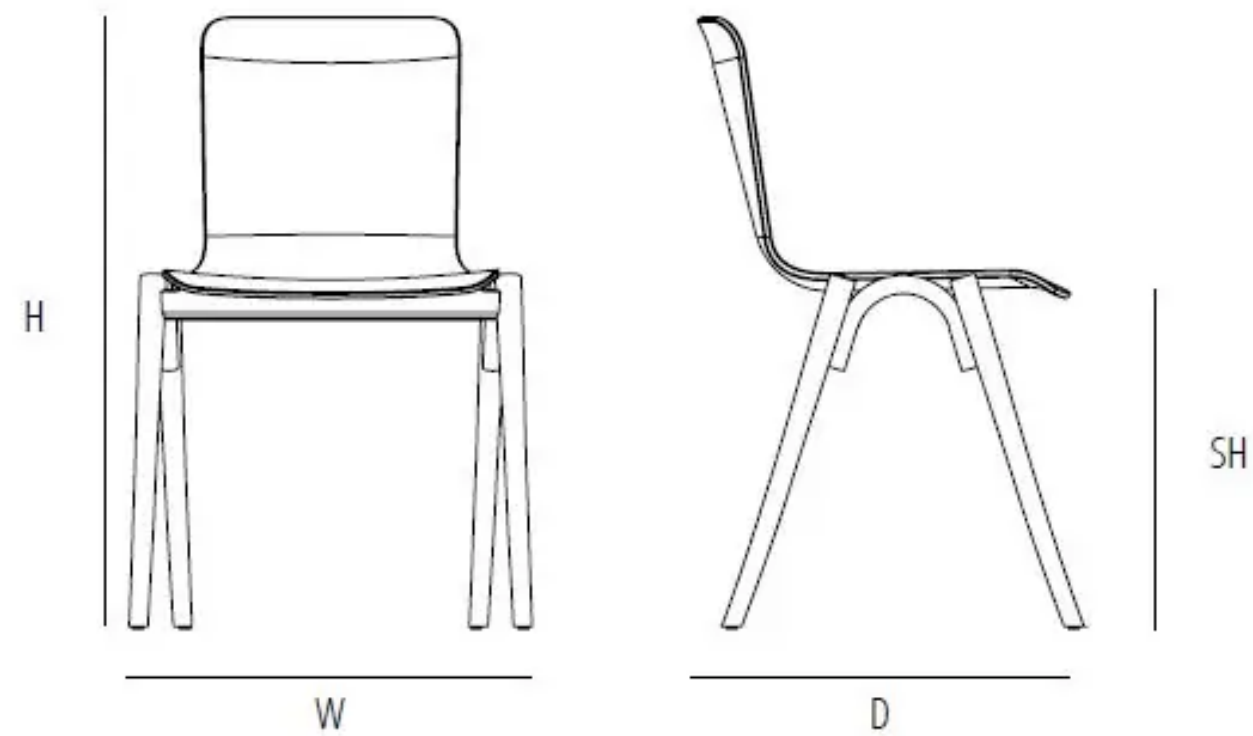

	H	W	D	SH
mm	815	560	510	460
inch	32	21,9	20	18,1

## SOLID WOOD



B01 BEECH  
B01 FAGGIO

## STAINS

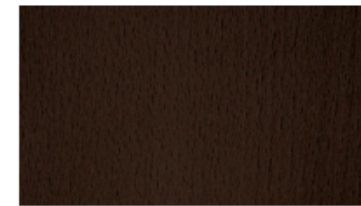

B03 DARK WALNUT  
B03 NOCE SCURO



B04 WENGÈ  
B04 WENGÈ



B08 BEECH-WOOD STAINED IN NOCE CANALETTO  
B08 FAGGIO TINTO NOCE CANALETTO

## COLOURED STAINS



GREEN/VERDE NCS S 5540 - B80G



RED/ROSSO NCS S 2070 - Y90R



# AMPLE COLLECTION

DESIGN BY NICHETTO STUDIO

Indoor / Outdoor

Nichetto Studio signs a **declination for outdoor** of the chair presented at the Salone del Mobile 2023, which this year is also joined by a **bistro table in two variants**, one of which is stackable.

Crafted to elevate both contract and residential environments with sophistication, the seating's seat and backrest, as well as the tabletops of the tables, are meticulously crafted from **iroko wood**. The structures feature a tubular steel frame.

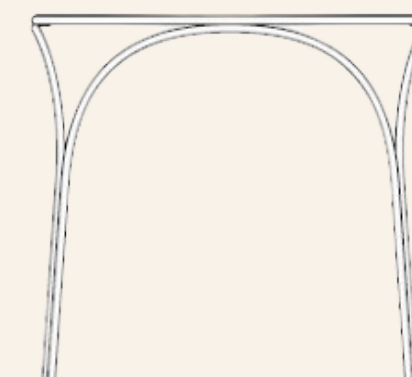
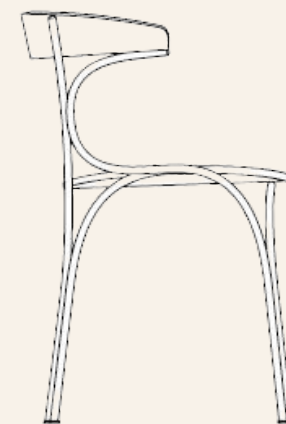

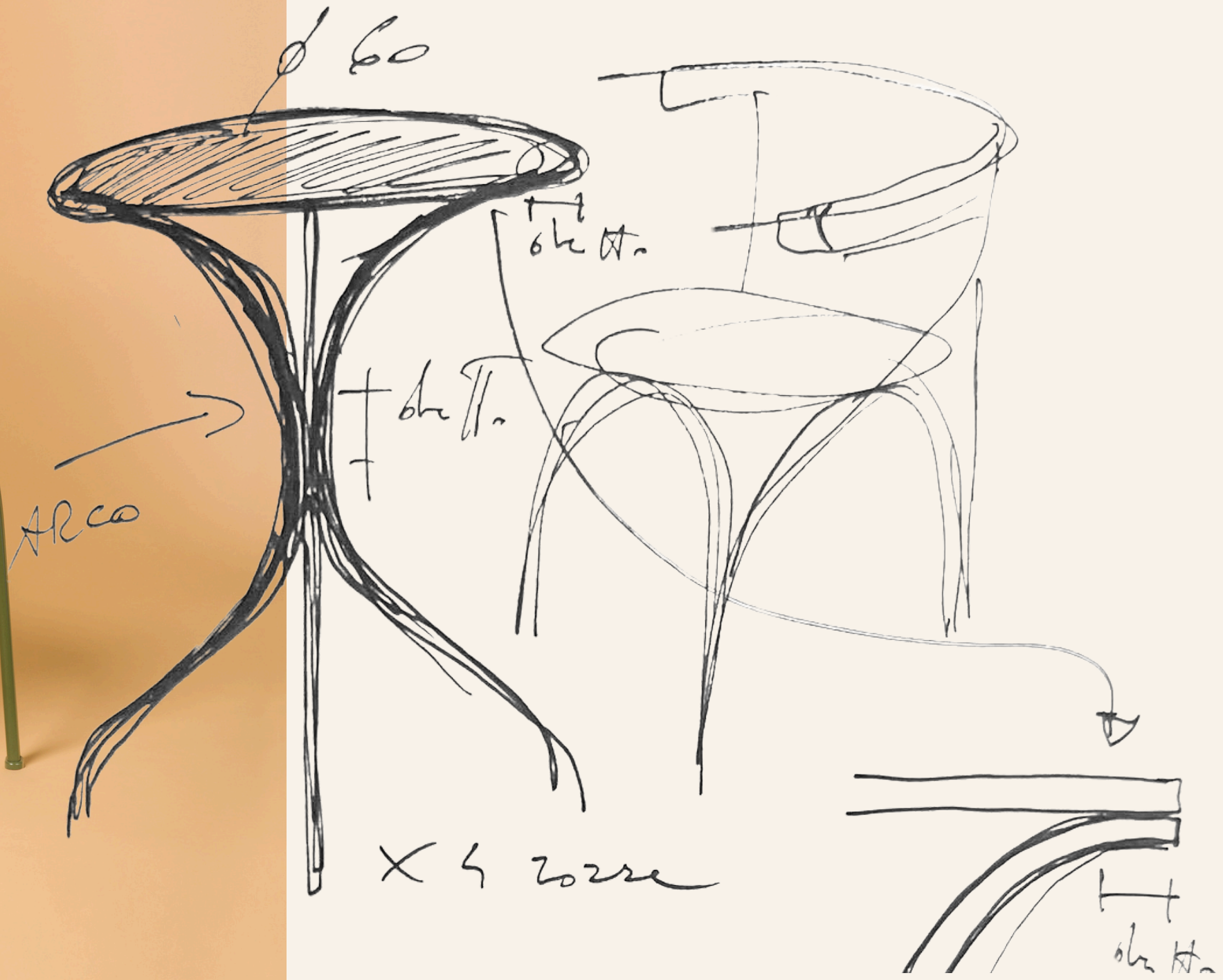



leggermente  
inclinato

G.  
A TRONET

# TECHNICAL DATA SHEET

AMPLE BISTROT TABLE | NICHETTO STUDIO



	H	W	D
mm	760	600	600
inch	29,9	23,6	23,6

## INDOOR FINISHING

### METAL FRAME

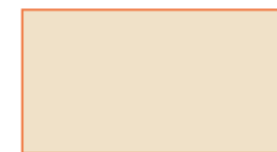

D01



D31



D32



D14

### WOODEN PARTS



B07



B03



D32



B07

## OUTDOOR FINISHING

### METAL FRAME

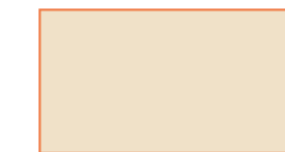

D01



D31



D14

### WOODEN PARTS



B09



B09



B09

# TECHNICAL DATA SHEET

AMPLE BISTROT TABLE | NICHETTO STUDIO

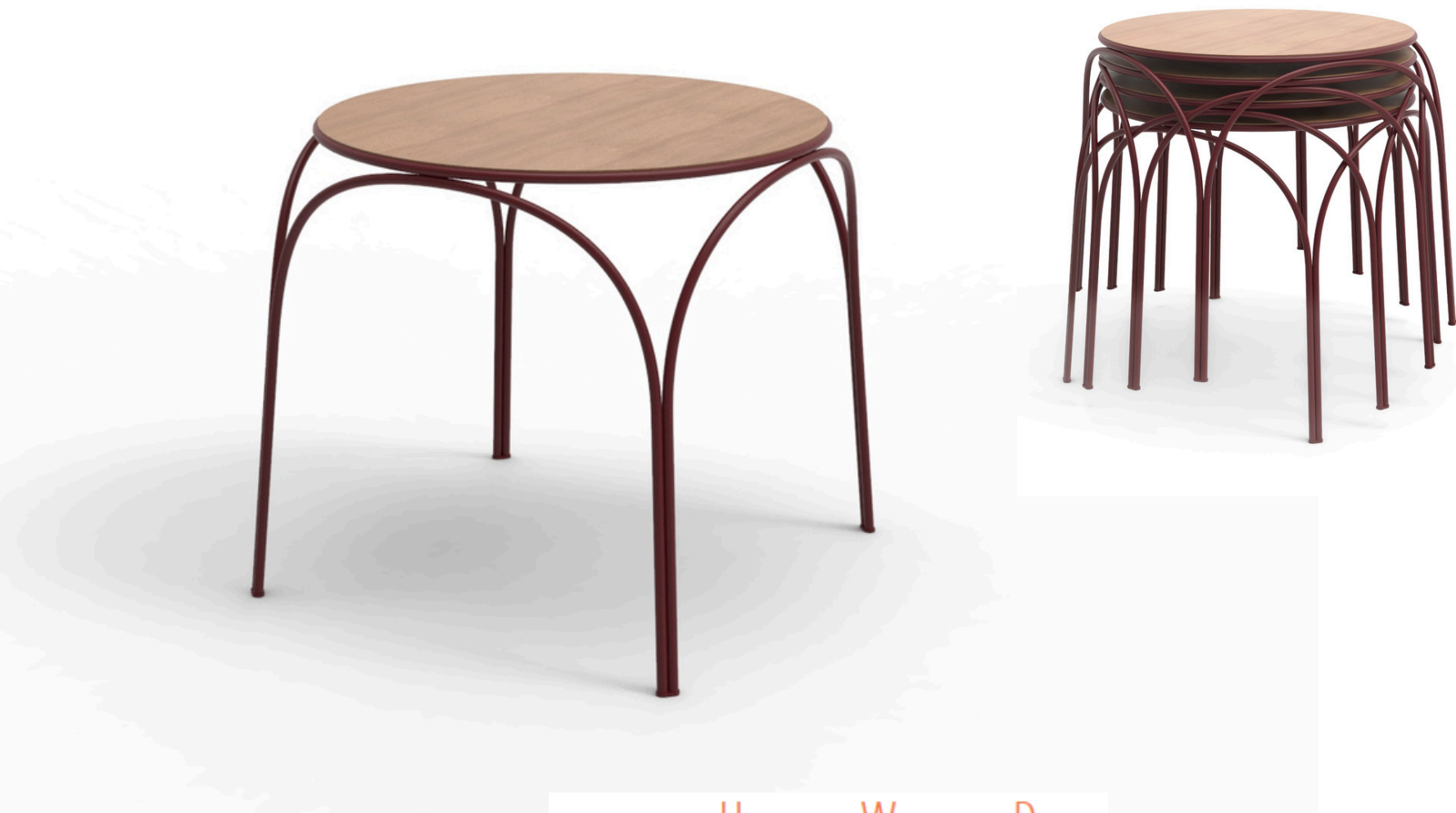

	H	W	D
mm	760	800	800
inch	29,9	31,4	31,4

## INDOOR FINISHING

### METAL FRAME



D01



D31



D32



D14

### WOODEN PARTS



B07

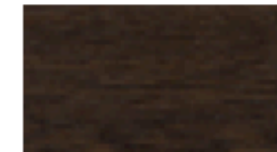

B03



D32



B07

## OUTDOOR FINISHING

### METAL FRAME



D01



D31



D14

### WOODEN PARTS



B09



B09



B09

# TECHNICAL DATA SHEET

AMPLE CHAIR | NICHETTO STUDIO

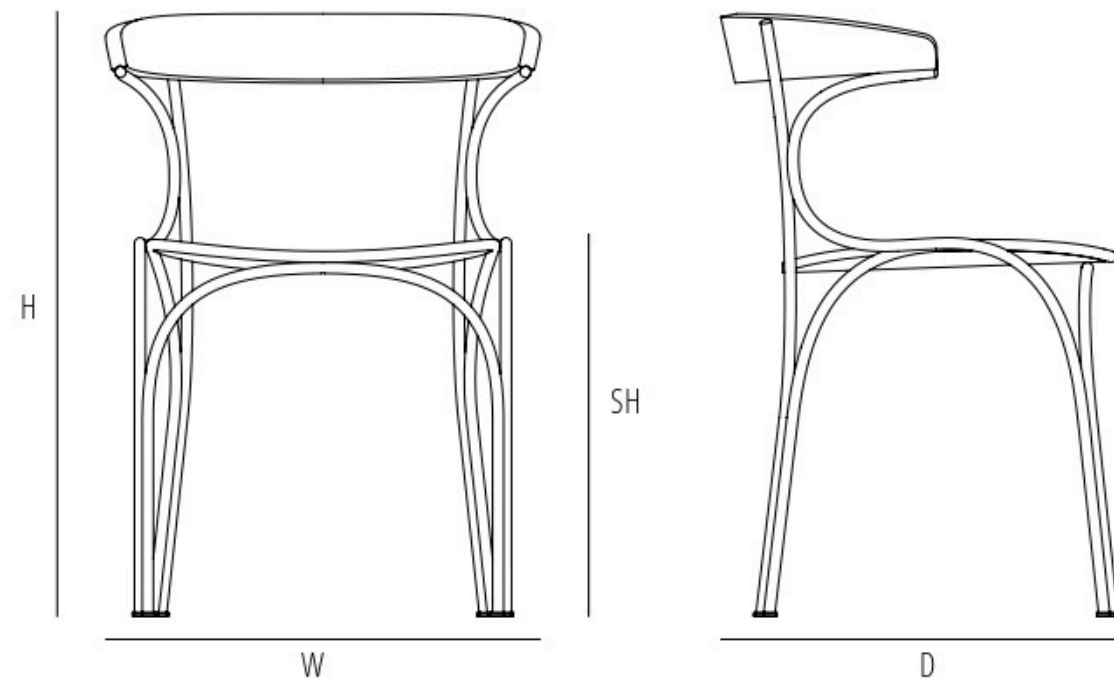

	H	W	D	SH
mm	750	530	500	450
inch	29,5	20,8	19,6	17,7

## INDOOR FINISHING

### METAL FRAME



D01



D31



D32



D14

### WOODEN PARTS



B07



B03



D32



B07

## OUTDOOR FINISHING

### METAL FRAME

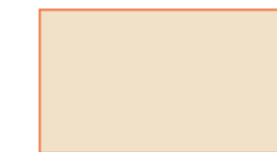

D01



D31



D14

### WOODEN PARTS



B09



B09



B09



## **SALES CONTACT**

For products enquiries:

[sales@gebruederthonetvienna.com](mailto:sales@gebruederthonetvienna.com)

## **MARKETING CONTACT**

Requests of communication material:

[gtv@gebruederthonetvienna.com](mailto:gtv@gebruederthonetvienna.com)



[gebruder\\_thonet\\_vienna](https://www.instagram.com/gebruder_thonet_vienna)